Connection Enablement: Morwell East Area

Regulatory Investment Test for Distribution (RIT-D)
Draft Project Assessment Report

Friday, 5 July 2024

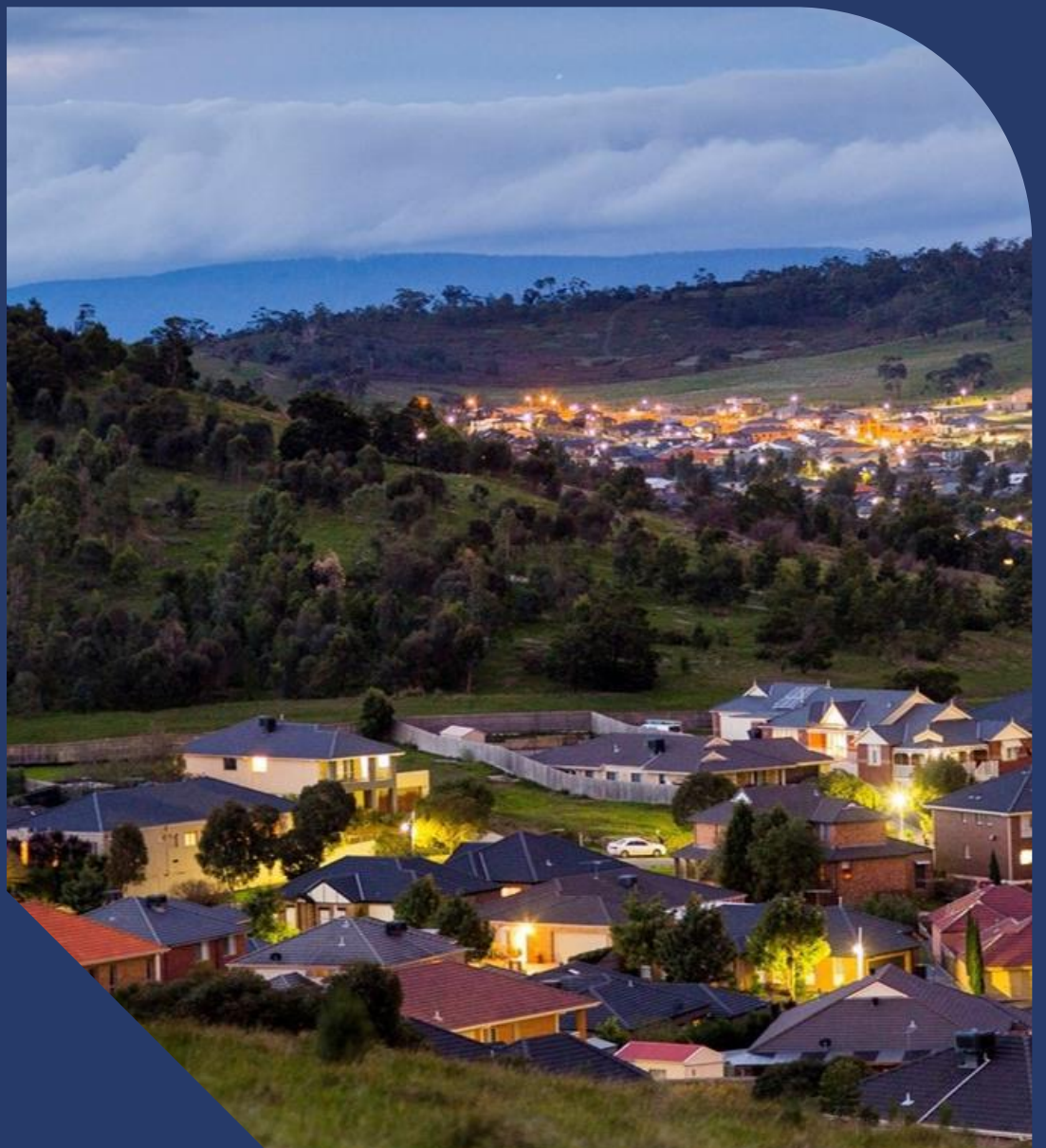

Table of contents

1. Executive summary	4
2. Introduction	6
3. Background	7
4. Identified need	8
4.1. Description	8
4.2. Assumptions	8
5. Credible options	11
5.1. Option 0: Do Nothing/BAU	11
5.2. Option 1: Augment No.1 line with 19/4.75 conductor	11
5.3. Option 2: Augment both lines with 19/4.75 conductor	11
5.4. Option 3: Augment both lines with 37/3.75 conductor	12
5.5. Non-network options	12
5.6. Options considered and not progressed	12
5.7. Material inter-regional network impact	13
6. Economic assessment of the credible options	14
6.1. Assessment approach	14
6.2. Material classes of market benefits	14
6.3. Methodology	15
6.4. Key variables and assumptions	16
6.5. Cost benefit analysis	17
6.6. Sensitivity analysis	18
6.7. Preferred option	19
6.8. Capital and operating costs of the preferred option	19
7. Next steps	20

7.1. Request for submissions	20
7.2. Next stage of RIT-D process	20
8. Satisfaction of the RIT-D	21
Appendix – RIT-D assessment and consultation process	23

1. Executive summary

AusNet is a regulated Victorian Distribution Network Service Provider (DNSP) that supplies electrical distribution services to more than 809,000 customers. Our electricity distribution network covers eastern rural Victoria and the fringe of the northern and eastern Melbourne metropolitan area.

As expected by our customers and required by the various regulatory instruments under which we operate, AusNet aims to maintain service levels at the lowest possible cost to our customers. To achieve this, we develop plans that aim to maximise the present value of economic benefit to all those who produce, consume and transport electricity in the National Electricity Market (NEM).

AusNet has received connection inquiries to connect a total of 1360 MW of renewable generation to the Morwell East sub-transmission (66 kV) network. The Morwell East sub-transmission network already has 123.1 MW of connected generation. The Morwell East sub-transmission network was planned, built, and maintained to meet the demand in that area and is not strong enough to connect significant additional renewable generation.

The Regulatory Investment Test for Distribution (RIT-D) is an economic cost-benefit test used to assess and rank potential investments capable of meeting an identified need. The purpose of the RIT-D is to identify the credible option that meets the identified need and maximises the present value of net economic benefit to all those who produce, consume and transport electricity in the NEM (the preferred option).

AusNet initiated this RIT-D by publishing the Options Screening Report (OSR) in January 2024 in accordance with clause 5.17 of the NER and section 4.2 of the AER's RIT-D Application Guidelines to investigate and evaluate options to address the constraints in the MWTS East sub-transmission network which are restricting new renewable generation connections. Publication of this Draft Project Assessment Report (DPAR) represents the second step in the RIT-D process.

AusNet received no non-network option or submissions for the OSR consultation.

AusNet followed the AER's RIT-D application guidelines to analyse and rank the economic cost and benefits of the investment options considered in this RIT-D. The robustness of the ranking was investigated through sensitivity analysis that involve variations of assumptions around the values used in the base case.

AusNet evaluated following network options to select the option that provides the highest net economic benefits:

1. Augment MWTS – TGN No.1 line with 19/4.75 conductor
2. Augment MWTS – TGN both lines with 19/4.75 conductor
3. Augment MWTS – TGN both lines with 37/3.75 conductor

A fourth option was also considered, but not progressed further as it was clearly inferior to options 1.

The economic analysis shows that the Option 2 "Augment MWTS – TGN both lines with 19/4.75 conductor" provides the highest net economic benefits for the two ISP scenarios that we have adopted in this DPAR, as shown in the table below. Further information on the scenario selection is provided in section 6.5 of this DPAR.

The following points should be noted in relation to the data provided in the table below:

- Financial data are expressed in present value terms and \$M, real 2024 prices; and
- The assessment period is over 49 years (2024/25 to 2072/73)

Table 1: Net economic benefit of each option for the assessed ISP scenarios in present value terms (\$M, real 2024)

Option	Progressive Change ISP Scenario	Step Change ISP Scenario
Option 1 - Augment MWTS – TGN No.1 line with 19/4.75 conductor	\$99.86M	\$77.94M
Option 2 - Augment MWTS – TGN both lines with 19/4.75 conductor	\$101.70M	\$89.33M
Option 3 - Augment MWTS – TGN both lines with 37/3.75 conductor	\$96.81M	\$71.91M

AusNet tested the robustness of the investment decision against six inputs in the sensitivity analysis. As shown in the diagram below, Option 2 provides the highest net economic benefit for all the sensitivities considered.

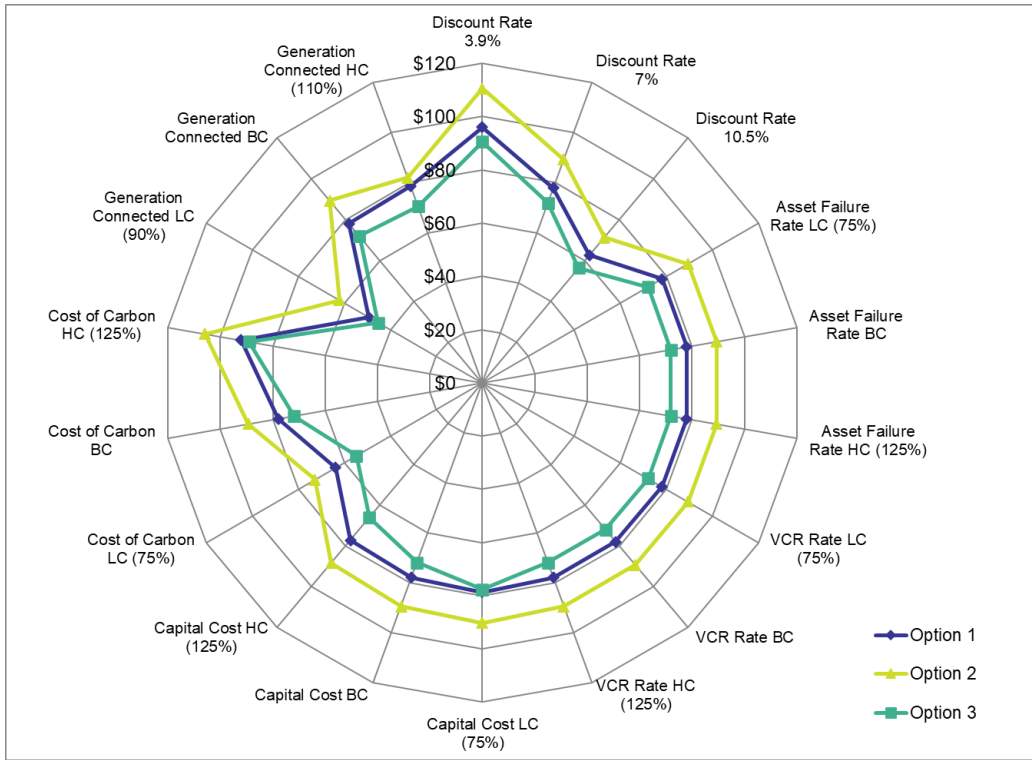

Figure 1: Sensitivity analysis of the six shown inputs on the net present value of each option (\$M, real 2024)

On the basis of the analysis presented in this DPAR, AusNet concludes that the Option 2 “Augment MWTS – TGN both lines with 19/4.75 conductor” is the preferred option to address the identified need described in this RIT-D.

AusNet welcomes written submissions on the credible options evaluation and draft conclusion presented in this DPAR. Submissions should be emailed to ritdconsultations@ausnetservices.com.au on or before Wednesday 21 August 2024. In the subject field, please reference 'RIT-D DPAR CE Morwell East'. AusNet's preference is that these submissions would be published on its website and AEMO's website. If you do not want your submission to be made public, please clearly stipulate this at the time of lodgement.

AusNet expect to publish the Final Project Assessment Report (FPAR) with the responses to the submissions received before the end of September 2024.

2. Introduction

The RIT-D is an economic cost-benefit test used to assess and rank potential investments capable of meeting the identified need. The purpose of the RIT-D is to identify the credible option that maximises the present value of net economic benefit to all those who produce, consume and transport electricity in the NEM (the preferred option).

The Options Screening Report (OSR) was published in January 2024 in accordance with clause 5.17 of the NER and section 4.2 of the AER's RIT-D Application Guidelines¹. Publication of this Draft Project Assessment Report (DPAR) represents the second step in the RIT-D process and describes the following:

- the identified need that AusNet is seeking to address;
- credible network options that may address the identified need;
- a summary of the submissions to the OSR;
- the assessment approach and assumptions that AusNet has employed for this RIT-D assessment as well as the specific categories of market benefits that are unlikely to be material; and
- the identification of the proposed preferred option and the draft conclusion.

The appendix provides an overview of the RIT-D assessment and consultation process.

¹ Australian Energy Regulator, "Application guidelines Regulatory investment test for distribution", August 2022.

3. Background

Morwell Terminal Station (MWTS) 66 kV is the main source of supply for a major part of south-eastern Victoria including Gippsland. AusNet is responsible for planning the transmission connection and distribution network for this region.

MWTS 66 kV is supplied by two 150 MVA 220/66 kV transformers and one 165 MVA 220/66 kV transformer. Maximum demand at MWTS 66 kV typically occurs in summer. The station recorded a maximum demand of 452 MW (464 MVA) in early January 2013. The maximum demand on the station reached 422.3 MW (425 MVA) in winter 2022. The maximum demand period is usually quite short and coincides with a few weeks of peak tourism from Christmas to early January along the east coast of Victoria – however driven by unusually cool 2022/2023 summer conditions the maximum demand occurred in winter 2022. The maximum demand at MWTS 66 kV is forecast to increase over the ten-year planning horizon.

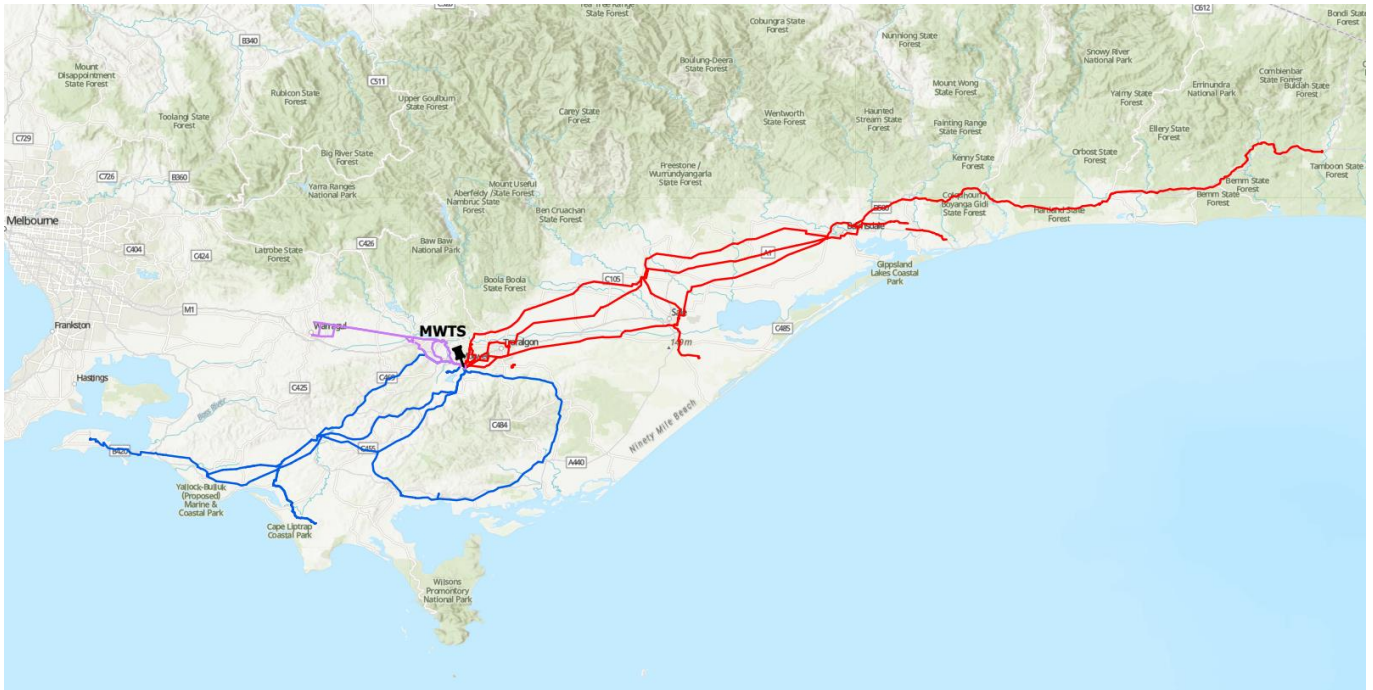

Figure 2: Map showing Morwell Terminal Station and the Morwell sub-transmission network

Morwell East network (shown in red) supplies Omeo in the north and Bairnsdale and Mallacoota in the east. Morwell South (shown in blue) supplies Phillip Island, Wonthaggi and Leongatha.

A total of 523.7 MW of embedded generation capacity is installed on the AusNet sub-transmission and distribution networks connected to MWTS². It consists of:

- 277.4 MW of large-scale embedded generation; and
- 246.3 MW of rooftop solar PV, including all the residential and small-scale commercial rooftop PV systems that are smaller than 1 MW.

Of this connected generation to MWTS, Morwell East network has 123.1 MW of large-scale connected generation.

² 2023 Transmission Connection Planning Report (TCPR)

4. Identified need

4.1. Description

As mentioned above, there is already 123.1 MW of large-scale embedded generation connected to Morwell East network. AusNet has received connection inquiries to connect a total of 1360 MW of renewable generation to Morwell East sub-transmission (66 kV) system, including a 77 MW solar farm which is at the committed stage between MWTS - MFA and an 80 MW solar farm in advanced stage between MWTS – SLE.³

The East Gippsland 66 kV network, which emanates from Morwell Terminal Station (MWTS), supplies over 71,200 customers via six AusNet zone substations, including Traralgon (TGN), Sale (SLE), Maffra (MFA), Bairnsdale (BDL), Newmerella (NLA) and Cann River (CNR)⁴. The following diagram sourced from the Distribution Annual Planning Report (DAPR) – 2024-2028 shows the Morwell East sub-transmission network (constrained line segments under single order contingency are coloured in red).

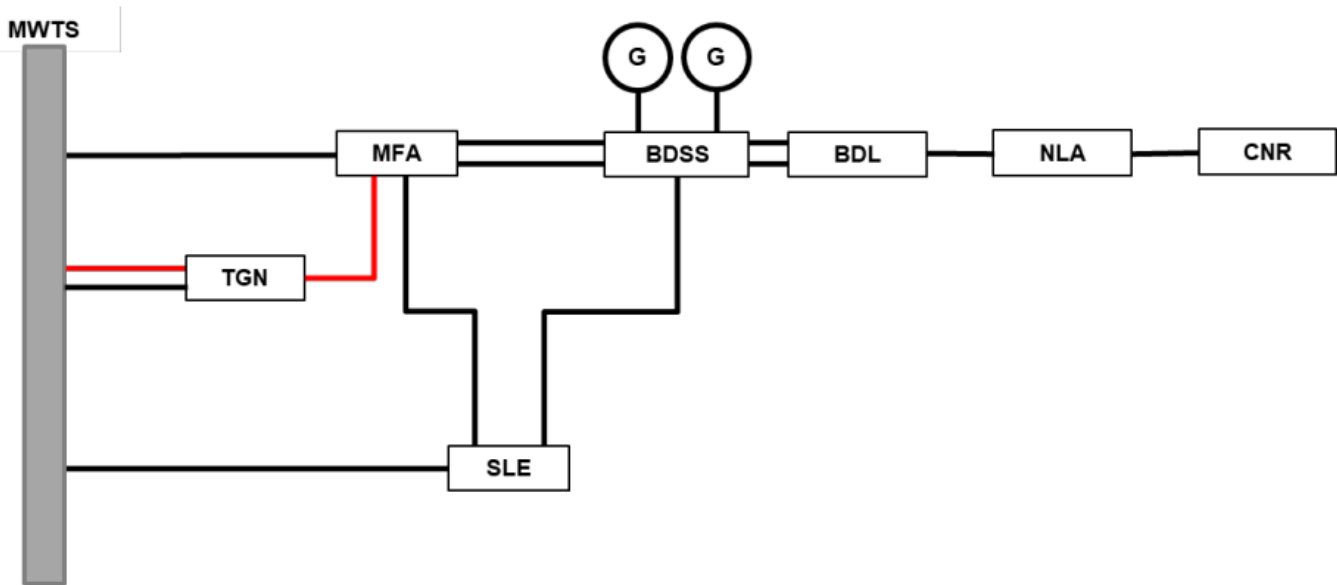

Figure 3: Morwell East sub-transmission network

As shown above, two 66 kV lines between MWTS and TGN are vital as a significant portion of the Morwell East is connected to MWTS through these two lines along with MWTS-MFA and MWTS-SLE lines. The MWTS-TGN No.1 line has a lower summer rating (39.44 MVA) constraining the No.2 line (with summer rating 91.45 MVA) operating in parallel. It is evident that the constraint of this portion is a major bottleneck for connecting new generation to the Morwell East network. The summer ratings of MWTS-MFA and MWTS-SLE lines are 73.73 MVA and 90.31 MVA respectively.

Through preliminary studies AusNet found that only a portion of the proposed generation connections could be accommodated by the existing assets, and the output of the connected generation would have to be curtailed during peak generation due to the existing constraints of the network.

The identified need of this RIT-D is to address the constraints between MWTS - TGN sub-transmission section (approximately 19 km) to enable more renewable generation to connect to AusNet's sub-transmission and distribution network in Morwell East network.

4.2. Assumptions

The identified need described in the previous section is underpinned by a number of assumptions, including the projected growth in renewable generation given the connection inquiries received; the risk of asset failure (determined by the condition of the assets); and the likelihood of the relevant consequences. In addition to these assumptions, AusNet adopted the assumptions detailed in the following subsections to quantify the risks associated with the identified need.

³ Latest information is available at [Subtransmission Ratings and Connections dashboard](#)

⁴ AusNet Distribution Annual Planning Report (DAPR) – 2024-2028

4.2.1. Market impact costs

Market models produce three key values for assessing net economic benefits:

- savings in total generation costs when new low-cost generation is introduced;
- curtailment of new low-cost generation; and
- savings in total generation costs when a network augmentation is introduced to reduce curtailment.

To determine whether enabling new generation connections is beneficial to electricity consumers as a whole, compared to the case without new generation:

- the sum of capital expenditure for the new generation and NEM-wide generation operating costs must be lower;
- curtailment of existing and new generation must be within bounds that are reasonably acceptable for generation proponents; and
- the capital cost of network augmentation must be lower than the savings developed by introducing the new generation.

Adhering to these three determinants leads to a future generation and transmission mix that reduces total costs to consumers. AusNet undertakes market modelling to assess hosting capacity, with and without the proposed augmentation. The assessment is performed using time-sequential modelling that takes account of:

- Projected changes in demand, with specific components that track potential growth in rooftop solar systems, electric vehicle penetration and charging habits, domestic and commercial battery installations, demand-side participation, and virtual power plant schemes utilizing aggregated batteries and vehicle-to-grid technologies.
- Addition of new transmission-connected generators and retirement of existing ageing generators according to AEMO's latest-available ISP projections.
- Addition of new interconnector projects according to AEMO's ISP projections.
- Projected changes in fuel costs for coal and gas-fired generators.
- Projected changes in fixed and variable generator operating costs, maintenance cycles and unplanned outages.
- National Electricity Market Dispatch Engine (NEMDE) constraint equations for regions outside Victoria.
- NEMDE constraint equations for electricity system stability in Victoria.
- Secure thermal operation under N-1 contingency conditions within Victoria, with reference to future changes in power flow.
- Multiple macroeconomic growth scenarios according to AEMO's latest-available Input Assumptions and Scenarios Report (IASR).
- Federal and State-based targets for renewable energy and emissions reduction.

Modelling is performed using hourly time intervals over multiple years to develop a long-term view that aligns with the operational lifetime of generation and transmission assets.

4.2.2. Emission reduction costs

Greenhouse gas emissions would be reduced by replacing fossil fuel powered generation with renewable generation. AusNet quantified the benefits from reductions in carbon emissions using the cost of carbon as given in the draft guidance published by the AER⁵.

4.2.3. Supply risk costs

In calculating the supply risk costs, AusNet estimates the expected unserved energy based on the most recent demand forecasts, and values this expected unserved energy with the latest AER Value of Customer Reliability (VCR)⁶. The VCR value applied is based on the sector values published by the AER and the composition of load, by sector, supplied from MWTS. The resulting estimate of the weighted VCR for affected customers is \$44,100/MWh for MWTS 66 kV.

4.2.4. Safety risk costs

⁵ <https://www.aer.gov.au/documents/aer-valuing-emissions-reduction-draft-guidance-march-2024>

⁶ In dollar terms, the Value of Customer Reliability (VCR) represents a customer's willingness to pay for the reliable supply of electricity. The values produced are used as a proxy, and can be applied for use in revenue regulation, planning, and operational purposes in the National Electricity Market (NEM).

The Electricity Safety Act 1998⁷ requires AusNet to design, construct, operate, maintain, and decommission its network to minimise hazards and risks to the safety of any person as far as reasonably practicable or until the costs become disproportionate to the benefits from managing those risks. By implementing this principle for assessing safety risks from asset failures, AusNet uses:

- a value of statistical life⁸ to estimate the benefits of reducing the risk of death;
- a value of lost time injury⁹; and
- a disproportionality factor¹⁰.

AusNet's approach, including the use of a disproportionality factor, is consistent with the guidance provided by the AER.

4.2.5. Financial risk costs

In the event of an asset failure, costs will be incurred in replacing the failed assets (and any consequential damage to other assets). The risk of this financial impact may vary for different credible options and, therefore, should be factored into the cost-benefit assessment.

⁷ Victorian State Government, Victorian Legislation and Parliamentary Documents, "Electricity Safety Act 1998," available at [Electricity Safety Act 1998 \(legislation.vic.gov.au\)](https://www.legislation.vic.gov.au/legislation/instruments/instrument-1998-0001)

⁸ Department of the Prime Minister and Cabinet, Australian Government, "Best Practice Regulation Guidance Note: Value of statistical life," available at <https://www.pmc.gov.au/resource-centre/regulation/best-practice-regulation-guidance-note-value-statistical-life>

⁹ Safe Work Australia, "The Cost of Work-related Injury and Illness for Australian Employers, Workers and the Community: 2012-13," available at <https://www.safeworkaustralia.gov.au/system/files/documents/1702/cost-of-work-related-injury-and-disease-2012-13.docx.pdf>

¹⁰ Health and Safety Executive's submission to the 1987 Sizewell B Inquiry suggesting that a factor of up to 3 (i.e., costs three times larger than benefits) would apply for risks to workers; for low risks to members of the public a factor of 2, for high risks a factor of 10. The Sizewell B Inquiry was public inquiry conducted between January 1983 and March 1985 into a proposal to construct a nuclear power station in the UK.

5. Credible options

This section describes the credible options that have been considered to address the identified need, including:

- the technical characteristics of each option;
- the estimated construction timetable and commissioning date; and
- the total indicative capital and operating and maintenance costs.

The purpose of the RIT-D is to identify the credible option for addressing the identified need that maximises the net market benefit. An important aspect of this task is to consider non-network and network options on an equal footing, so that the optimal solution can be identified, evaluated and determined.

None of the options considered are expected to have an inter-regional impact. Each credible option is discussed below, including the Do Nothing/BAU option. The network option costs have been updated to reflect our latest cost estimates.

5.1. Option 0: Do Nothing/BAU

The Do Nothing/BAU option assumes that AusNet would not undertake any investment, outside of the normal operational and maintenance processes. The Do Nothing/BAU (Business as Usual) option establishes the base level of risk (base case) and provides a basis for comparing other credible options.

5.2. Option 1: Augment No.1 line with 19/4.75 conductor

The existing summer rating of the No.1 MWTS – TGN 66 kV line is 39.44 MVA. This option includes replacing the lower rated line sections with higher rated 19/4.75 AAC conductor to increase the overall line summer rating to 105 MVA. This option is expected to increase the summer rating of both lines from 79 MVA (39.44 x 2) to 183 MVA (91.45 x 2). This option would utilise the full summer rating of the No.2 line as the summer rating of the augmented No.1 would be higher than the No.2 line. (This option was the OSR option 2)

The construction would commence in October 2024, with project completion expected by December 2026. The estimated capital cost of this option is \$3.80 million.

In relation to O&M expenditure, AusNet does not expect this option to have a material impact on future O&M costs.

5.3. Option 2: Augment both lines with 19/4.75 conductor

This is a new option that was not included in the OSR. This option is similar to Option 3 above, the only difference being replacing both lines with 19/4.75 AAC conductor. The construction of this option would be simpler than Option 3 as most sections of the lines are already of 19/4.75 AAC conductor and hence significantly lower implementation cost compared with the Option 3. This augmentation would increase the summer rating of the No.1 MWTS – TGN 66 kV line to 105 MVA and the No.2 MWTS – TGN 66 kV line to 101 MVA, making the new overall MWTS – TGN summer rating to 202 MVA (101 x 2) due to both lines operating in parallel with similar impedances.

The construction would commence in October 2024, with project completion expected by December 2026. The estimated capital cost of this option is \$4.81 million.

In relation to O&M expenditure, AusNet does not expect this option to have a material impact on future O&M costs.

5.4. Option 3: Augment both lines with 37/3.75 conductor

This option is similar to Option 2 above, the only difference being replacing both lines with 37/3.75 AAC conductor. When replacing an existing line with a higher rated conductor, most of the poles will have to be replaced with new poles due to the higher weight of the conductor. This augmentation would increase the summer rating of each line to 118 MVA making the new overall MWTS – TGN summer rating to 236 MVA (118 x 2). (This option was the OSR option 3).

The construction would commence in October 2024, with project completion expected by December 2026. The estimated capital cost of this option is \$30.08 million.

In relation to O&M expenditure, AusNet does not expect this option to have a material impact on future O&M costs.

5.5. Non-network options

In the OSR, AusNet sought submissions from non-network proponents that could contribute to addressing the identified need. The OSR included a table which set out the curtailment reductions that a non-network option placed preferably at Traralgon connecting to Traralgon Zone Substation (TGN) would be required to deliver. We explained that the non-network option would need to mitigate the risks associated with the curtailed renewable generation from existing generators in the Traralgon area and from new generation connecting into this area due to the constraints between MWTS – TGN sub-transmission section. The information presented provided an indication of the required operating profile, noting that prospective non-network service providers may not be able to exactly match these requirements.

AusNet received no non-network options or submissions in response to the OSR. On that basis, we have concluded that there are no credible non-network options that could address the identified need.

5.6. Options considered and not progressed

Augmenting the No.1 line with 37/3.75 AAC conductor was initially considered but did not progress further. In the absence of augmenting the No.2 line, this option would only provide marginal additional benefit compared to Option 1 (augmenting No.1 line with 19/4.75 AAC) as MWTS – TGN No.1 and No.2 lines are operating in parallel, while the cost would be significantly higher. On that basis, this option would be inferior to Option 1.

In this case the augmented No.1 line would have a summer rating of 118 MVA but the summer rating of No.2 line stays the same at 91.45 MVA as the constraining element.

The OSR Option 1 was to augment No.1 line with 19/3.25 conductor. The existing summer rating of the No.1 MWTS – TGN 66 kV line is 39.44 MVA. This option includes replacing the lower rated line sections with higher rated 19/3.25 AAC conductor to increase the overall line summer rating to 64 MVA. This option is expected to increase the summer rating of both lines from 79 MVA (39.44 x 2) to 128 MVA (64 x 2). However, this option will not be able to utilise the full summer rating of the No.2 line as the augmented capacity of No. 1 line will remain below the summer rating of No.2 line (91.45 MVA).

The estimated capital cost of this option is \$3.79 million. This option provides much lower summer rating increase (only 128 MVA) compared with the Option 2 (183 MVA) whereas augmentations costs are of the same order (\$3.80M vs \$3.79M). As it is obvious that the Option 2 provides higher benefits for the investment than Option 1, this option is not progressed further.

Minor line rating improvements of the existing MWTS-TGN lines can be obtained through Dynamic Line Rating (DLR) technology which has the capability to monitor ambient temperature, wind condition, line loading and conductor behaviour (sag/shape) and use that information to "calibrate" the line rating in real time. However, the existing line rating improvement through DLR technology is limited and not sufficient to meet the identified need. Therefore, this option has not been progressed.

5.7. Material inter-regional network impact

The proposed augmentations between MWTS - TGN will not change the transmission network configuration and none of the network options considered are likely to have a material inter-regional network impact. A 'material inter-regional network impact' is defined in the NER as:

"A material impact on another Transmission Network Service Provider's network, which may include (without limitation): (a) the imposition of power transfer constraints within another Transmission Network Service Provider's network; or (b) an adverse impact on the quality of supply in another Transmission Network Service Provider's network."

6. Economic assessment of the credible options

6.1. Assessment approach

Consistent with the RIT-D requirements and RIT-D Application guidelines¹¹, AusNet undertook a cost-benefit analysis to evaluate and rank the net economic benefits of the credible options over a 49-year period.

All options considered has been assessed against a business-as-usual case or base case where no proactive capital investment to address the identified need is made.

6.2. Material classes of market benefits

Clause 5.17.4 (j)(5) of the NER requires the RIT-D proponent to consider whether each credible option provides the classes of market benefits described in clause 5.17.1 (d). To address this requirement, the table below discusses our approach to each of the market benefits listed in that clause for each credible option.

Table 2: Analysis of Market Benefits

Class of Market Benefit	Analysis
<i>(i) changes in voluntary load curtailment;</i>	Any changes in voluntary load curtailment will be valued in accordance with any applicable network support agreements that may be in place.
<i>(ii) changes in involuntary load shedding and customer interruptions caused by network outages, using a reasonable forecast of the value of electricity to customers;</i>	The credible options may reduce involuntary load shedding, by increasing network capacity. Our approach to estimating this benefit is explained in section 4.2.3
<i>(iii) changes in costs for parties, other than the RIT-D proponent, due to differences in:</i> <i>(A) the timing of new plant;</i> <i>(B) capital costs; and</i> <i>(C) the operating and maintenance costs;</i>	There is not expected to be any difference between the credible options.
<i>(iv) differences in the timing of expenditure;</i>	There is not expected to be any difference between the credible options.
<i>(v) changes in load transfer capacity and the capacity of distribution connected units to take up load</i>	There is not expected to be any difference between the credible options.
<i>(vi) any additional option value (where this value has not already been included in the other classes of market benefits) gained or foregone from implementing the credible option with respect to the likely future investment needs of the NEM</i>	There will be no impact on the option value in respect of the likely future investment needs of the NEM.
<i>(vii) changes in electrical energy losses;</i>	The credible options are not expected to result in material changes to electrical energy losses.

¹¹ Australian Energy Regulator, "Application guidelines – Regulatory investment test for distribution" available at <https://www.aer.gov.au/documents/aer-rit-d-guidelines-final-amendments-clean-6-october-2023>

(viii) changes in Australia's greenhouse gas emissions	The credible options may reduce greenhouse gas emissions. Our approach to estimating this market benefit is explained in section 4.2.2
(ix) any other class of market benefit determined to be relevant by the AER.	There are no other classes of market benefit that are relevant to the credible options.

6.3. Methodology

The purpose of this section is to provide a high-level explanation of our methodology for identifying the preferred option. As a general principle, it is important that the methodology takes account of the identified need and the factors that are likely to influence the choice of the preferred option. As such, the methodology is not a 'one size fits all' approach, but one that is tailored to the particular circumstances under consideration.

For this project, there is a significant market benefit component, which is addressed by the market modelling, as described in 4.2.1. Specifically, the reduction in wholesale energy costs that arise from the augmentation is a key factor in the cost benefit analysis.

The preferred option is the one that delivers the lowest total cost to customers, which is the sum of the cost of implementing that option and any residual risk-cost. The identification of the preferred option is complicated by the fact that the future is uncertain and that various input parameters are 'best estimates' rather than known values. Therefore, the RIT-D analysis must be conducted in the face of uncertainty.

To address uncertainty in our assessment of the credible options, we use sensitivity analysis and scenario analysis in our cost benefit assessment. As recommended by the AER's application guidelines, we use sensitivity analysis to assist in determining a set of reasonable scenarios. The relationship between sensitivity analysis and scenarios is best explained by the AER's practice note:¹²

Scenarios should be constructed to express a reasonable set of internally consistent possible future states of the world. Each scenario enables consideration of the prudent and efficient investment option (or set of options) that deliver the service levels required in that scenario at the most efficient long run service cost consistent with the National Electricity Objective (NEO).

Sensitivity analysis enables understanding of which input values (variables) are the most determinant in selecting the preferred option (or set of options). By understanding the sensitivity of the options model to the input values a greater focus can be placed on refining and evidencing the key input values. Generally, the more sensitive the model output is to a key input value, the more value there is in refining and evidencing the associated assumptions and choice of value.

Scenario and sensitivity analyses should be used to demonstrate that the proposed solution is robust for a reasonable range of futures and for a reasonable range of positive and negative variations in key input assumptions. NSPs should explain the rationale for the selection of the key input assumptions and the variations applied to the analysis.

In applying sensitivities and scenarios to our cost benefit assessment, we have regard to the different circumstances that may eventuate that would affect the choice of the preferred option. Where our analysis shows that an option is clearly preferred, we will not undertake further testing. This approach is consistent with clause 5.17.1(c)(2) of the Rules, which states that the RIT-D must not require a level of analysis that is disproportionate to the scale and likely impact of each credible option considered.

In preparing the RIT-D, we have also had regard to AEMO's 2023 Inputs, Assumptions and Scenarios Report (IASR) and its 2024 Integrated System Plan (ISP). We note that the current IASR scenarios are Progressive Change, Step Change and Green Energy Exports, which are expressed in terms of their respective contributions to Australia's possible decarbonisation future, as depicted in the figure below.

¹² AER, Asset replacement planning, January 2019, page 36.

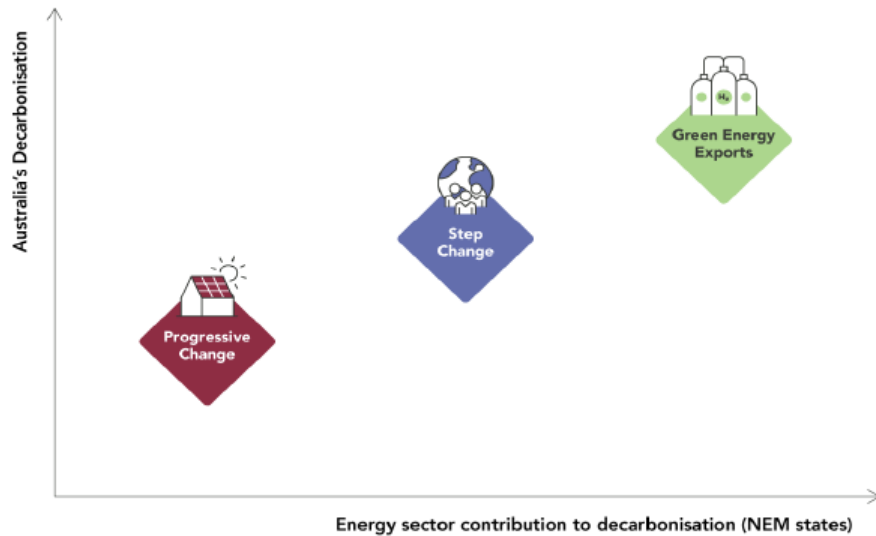

Figure 4: AEMO's scenarios for its 2023 IASR¹³

We note that the scenarios adopted by AEMO in its 2023 IASR are focused principally on the matters that are relevant to major transmission investments, rather than smaller transmission investments of the type considered in this report. Furthermore, we are also conscious that the identified need arises from the connection inquiries that we have already received, rather than projected changes in renewable generation connecting to this portion of our network.

In conducting the net economic benefit analysis, we focused our initial analysis on the step change and progressive change scenarios, to determine whether we were obtaining a consistent decision signal in relation to one of the options. Depending on the outcome of this initial analysis, our methodology is to assess at that stage whether further market modelling for the Green Energy Exports scenario is warranted. In our view, we regard this two-step approach as a pragmatic way of balancing the costs of undertaking further market modelling against the benefits that it would provide in relation to the investment decision. We discuss our findings and scenario selection in section 6.5.

6.4. Key variables and assumptions

Table 3 below lists the key variables and assumptions applied in the economic assessment, which are essential inputs to our methodology for the purpose of this DPAR. The table also sets out the upper and lower bounds of the range of forecasts adopted for each of these variables. The lower bound and upper bound estimates are used to undertake sensitivity testing and scenario analysis. The detailed results of this modelling are provided in the next section.

In relation to the discount rate, we have adopted central, upper and lower bound estimates that are consistent with AEMO's IASR in July 2023. We note that discount rates are subject to change, particularly in the current economic climate. As such, the rates employed in this DPAR are considered reasonable in exploring the impact of different rates on the cost-benefit assessment of the competing options to address the identified need.

Table 3: Input assumptions used for sensitivity studies

Parameter	Lower Bound	Central (Base) Case	Higher Bound
Project Cost	AusNet estimate - 25%	AusNet estimate	AusNet estimate + 25%
Cost of Carbon ¹⁴	AER estimate - 25%	AER estimate	AER estimate +25%
Value of Customer Reliability (VCR) ¹⁵	AER estimate - 25%	AER estimate	AER estimate +25%
Asset Failure Rate	AusNet assessment - 15%	AusNet assessment	AusNet Assessment +15%
Discount Rate	3.9%	7.0%	10.5%
Generation Connected	90% of the generation modelled	100% of Generation Modelled	110% Of Generation Modelled

¹³ AEMO, Inputs, Assumptions and Scenario Report 2023, July 2023, page 4.

¹⁴ AER, Valuing emissions reduction - AER guidance and explanatory statement, May 2024.

¹⁵ AER, 2023 Values of Customer Reliability Annual Adjustment, December 2023.

6.5. Cost benefit analysis

The economic analysis allows comparison of the economic cost and benefits of each option to rank the options and to determine the optimal timing of the preferred option. It quantifies the capital costs and the cost of the residual risk for each option, to determine a total cost for each option. The net economic benefit for each credible option is the total cost associated with that option minus the costs of the Do Nothing/BAU option.

AusNet considered following 3 network options in the evaluation to find the preferred option to address the identified need.

1. Augment MWTS – TGN No.1 line with 19/4.75 conductor
2. Augment MWTS – TGN both lines with 19/4.75 conductor
3. Augment MWTS – TGN both lines with 37/3.75 conductor

As already explained, each of these options will provide additional network capacity to enable more renewable generation to connect, deliver positive market benefits and reduce carbon emissions, in accordance with the National Electricity Objective.

Table 4 presents the costs and benefits for the Step Change and Progressive Change scenarios. As explained in section 6.3, the results from this initial assessment will determine whether it is necessary to undertake market modelling for the Green Energy Exports scenario. The data presented is expressed in present value terms and in \$m real 2024 prices. The assessment period is 49 years covering the period from 2024/25 to 2072/73.

The presentation of the data in Table 4 shows the costs of each option, which are the same for both scenarios. This is followed by data on the total benefits and net economic benefits for each option under the Step Change and Progressive Change scenarios.

Table 4: Cost benefit analysis and net economic benefits for each option in present value terms (\$M, real 2024)

	<u>Option 1</u>	<u>Option 2</u>	<u>Option 3</u>
Costs			
Capital Expenditure	-\$2.90M	-\$3.67M	-\$22.95M
Total costs	-\$2.90M	-\$3.67M	-\$22.95M
Step Change scenario: Total benefits and net economic benefits			
Generation Redispatch + Unserved Energy + Demand-side Participation	\$18.93M	\$19.68M	\$20.82M
Emissions Reductions	\$61.91M	\$73.32M	\$74.04M
Total Benefits	\$80.84M	\$93.00M	\$94.86M
Option Net Economic Benefit	\$77.94M	\$89.33M	\$71.91M
Progressive Change scenario: Total benefits and net economic benefits			
Generation Redispatch + Unserved Energy + Demand-side Participation	\$15.47M	\$12.03M	\$15.51M
Emissions Reductions	\$87.29M	\$93.34M	\$104.24M
Total Benefits	\$102.76M	\$105.37M	\$119.76M
Option Net Economic Benefit	\$99.86M	\$101.70M	\$96.81M

The above table shows the net economic benefit for each of the three options compared to the 'do nothing/BAU' option for the Step Change and Progressive Change scenarios. Both options show that Option 2 is preferred, delivering a net economic benefit of \$89.33 million and \$101.70 million in present value terms for the Step Change and Progressive Change scenarios. The weighting of the options has no bearing on the selection of the preferred option.

In our view, given the consistent results for both scenarios, we do not consider it necessary to undertake modelling for the Green Energy Exports Scenario.

6.6. Sensitivity analysis

AusNet has tested the robustness of the investment decision by varying six inputs for the Step Change scenario, as shown in Figure 5: Sensitivity analysis of the six shown inputs on the net present value of each option (\$M, real 2024) below. The sensitivity study results show that all the credible options considered would continue to provide positive net economic benefits for each sensitivity, while the Option 2 "Augment MWTS – TGN both lines with 19/4.75 conductor" continues to provide the highest net economic benefits in all cases.

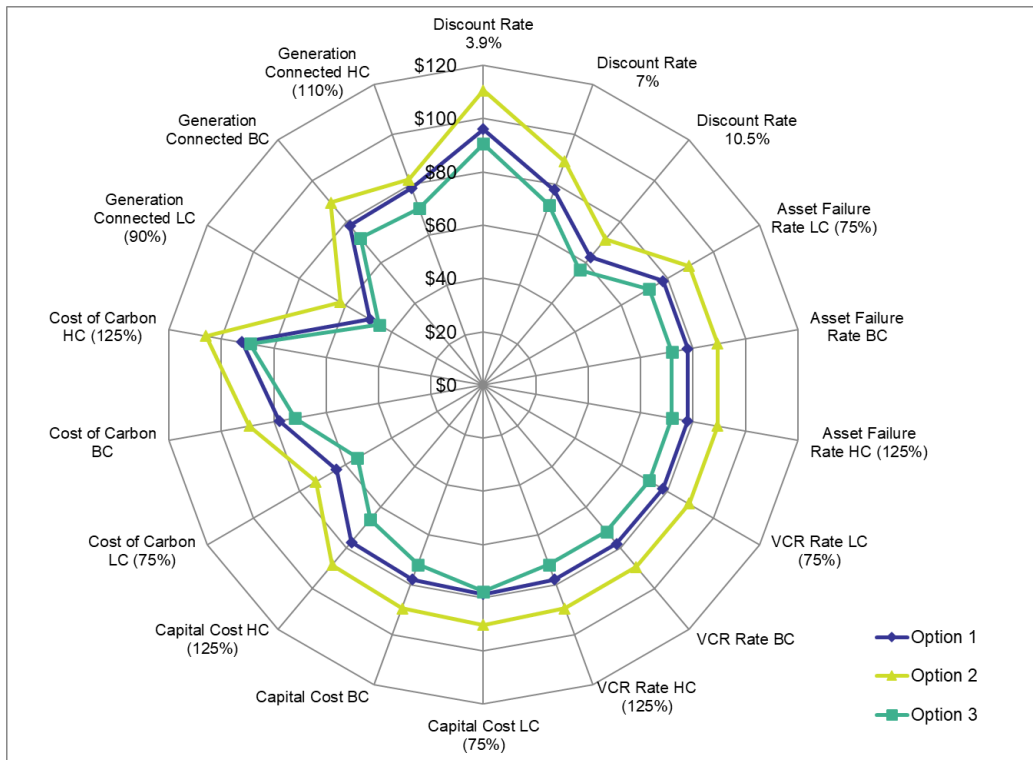

Figure 5: Sensitivity analysis of the six shown inputs on the net present value of each option (\$M, real 2024)

6.7. Preferred option

The preferred option (Option 2) is to:

- Augment the MWTS – TGN No.1 and No.2 66kV lines with 19/4.75 conductor to increase the overall summer rating of MWTS – TGN to 202 MVA, including the installation of conductor poles and associated equipment.

The construction would commence in October 2024, with project completion expected by December 2026. The estimated capital cost of this option is \$4.8 million (nominal).

In accordance with the RIT-D, this option is expected to maximise the present value of the net economic benefit to all those who produce, consume and transport electricity in the NEM.

6.8. Capital and operating costs of the preferred option

The direct capital expenditure of the preferred option (Option 2) is \$4.45 million (\$, nominal). The principal direct capital expenditure elements, expressed in nominal terms, are:

- Design and internal labour, \$0.44 million;
- Materials, plant and equipment, \$0.92 million;
- Contracts, \$2.39 million; and
- Other, \$0.7 million.

7. Next steps

7.1. Request for submissions

AusNet invites written submissions, on the matters set out in this report, from Registered Participants, AEMO, interested parties, non-network service providers and those registered on our demand-side engagement register.

All submissions and enquiries should be directed to:

Email: ritdconsultations@ausnetservices.com.au

Submissions are due on or before Wednesday 21 August 2024 and should refer to 'RIT-D DPAR CE Morwell East' in the subject heading.

Submissions will be published on AusNet's and AEMO's websites. If you do not wish to have your submission published, please clearly stipulate this at the time of lodging your submission.

7.2. Next stage of RIT-D process

Following the conclusion of the consultation period for this report, AusNet will, having regard to any submissions received, prepare and publish the FPAR which will include:

- A summary of, and commentary on, any submissions received.
- Preferred option to address the identified need.

AusNet expects to publish the FPAR before the end of September 2024.

8. Satisfaction of the RIT-D

In accordance with clause 5.17.4(j)(11)(iv) of the Rules, we certify that the proposed option satisfies the regulatory investment test for distribution. The table below shows how each of these requirements have been met by the relevant section of this report.

Table 5: Compliance with regulatory requirements

Requirement	Section
Clause 5.17.4(j) of the NER - The draft project assessment report must include the following:	Noted. See details below.
(1) a description of the identified need for the investment;	Section 4.
(2) the assumptions used in identifying the identified need (including, in the case of proposed reliability corrective action, reasons that the RITD proponent considers reliability corrective action is necessary);	Section 4.2
(3) if applicable, a summary of, and commentary on, the submissions on the options screening report;	No submissions were received.
(4) a description of each credible option assessed;	Section 5.
(5) where a Distribution Network Service Provider has quantified market benefits in accordance with clause 5.17.1 (d), a quantification of each applicable market benefit for each credible option;	Section 6.5
(6) a quantification of each applicable cost for each credible option, including a breakdown of operating and capital expenditure;	Section 5 and 6.8.
(7) a detailed description of the methodologies used in quantifying each class of cost and market benefit;	Sections 6.2 and 6.3.
(8) where relevant, the reasons why the RIT-D proponent has determined that a class or classes of market benefits or costs do not apply to a credible option;	Section 6.2
(9) the results of a net present value analysis of each credible option and accompanying explanatory statements regarding the results;	Section 6.5
(10) the identification of the proposed preferred option;	Section 6.7
(11) For the proposed preferred option, the RIT-D proponent must provide:	
(i) details of the technical characteristics;	Section 5.3 and 6.7
(ii) the estimated construction timetable and commissioning date;	Section 5.3 and 6.7.
(iii) the indicative capital and operating cost (where relevant);	Section 6.8
(iv) a statement and accompanying detailed analysis that the proposed preferred option satisfies the regulatory investment test for distribution; and	Section 6.5

Requirement	Section
(V) if the proposed preferred option is for reliability corrective action and that option has a proponent, the name of the proponent;	Not applicable as the preferred option is not for reliability corrective action
(12) contact details for a suitably qualified staff member of the RIT-D proponent to whom queries on the draft report may be directed; and	Section 7.1
(13) if the estimated capital cost of the proposed preferred option is greater than \$100 million (as varied in accordance with a cost threshold determination), include the RIT reopening triggers applying to the RIT-D project	Not applicable as the capital cost of the proposed preferred option is less than \$100 million

Appendix – RIT-D assessment and consultation process¹⁶

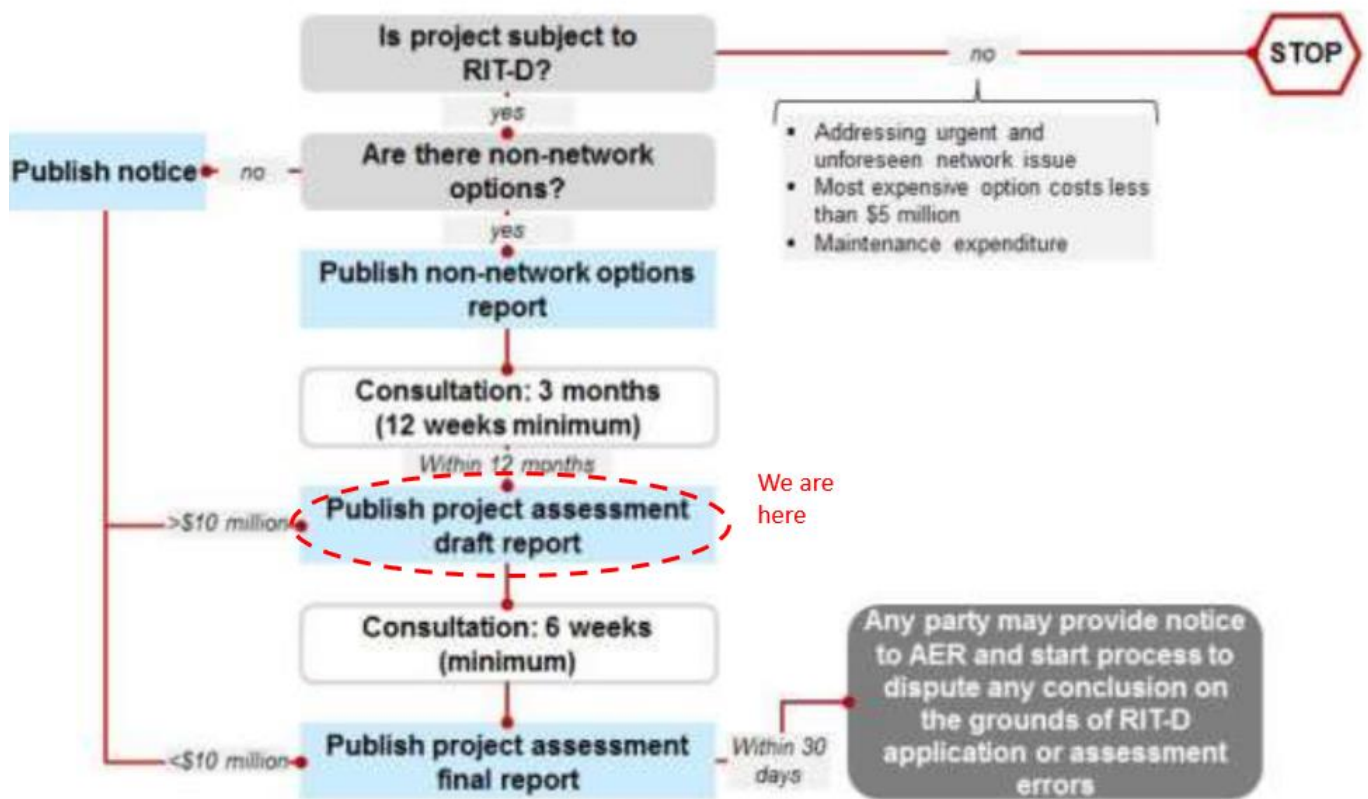



¹⁶ Section 4 - Australian Energy Regulator, "Application guidelines Regulatory investment test for distribution" August 2022

AusNet Services

Level 31
2 Southbank Boulevard
Southbank VIC 3006
T +613 9695 6000
F +613 9695 6666
Locked Bag 14051 Melbourne City Mail Centre Melbourne VIC 8001
www.AusNetServices.com.au

Follow us on

-  @AusNetServices
-  @AusNetServices
-  @AusNet.Services.Energy

AusNet

