

Dynamic Model Acceptance Test Guideline

Prepared by: AEMO [National Connections Onboarding and Connections](#)

Version: 3

Effective date: 3 June 2024

Status: DRAFT

aemo.com.au

New South Wales | Queensland | South Australia | Victoria | Australian Capital Territory | Tasmania | Western Australia

Australian Energy Market Operator Ltd ABN 94 072 010 327

Important notice

Purpose

This Guideline provides information to National Electricity Market participants about the assessment and testing process AEMO undertakes before accepting new or updated plant models for use in system studies and due diligence assessments for connection applications, registrations and plant alterations.

Participants and vendors should ensure they refer to the most recent version of this document for AEMO's general requirements.

Disclaimer

This document or the information in it may be updated or amended from time to time. This document does not constitute legal or business advice, and should not be relied on as a substitute for obtaining detailed advice about the National Electricity Law, the National Electricity Rules, or any other applicable laws, procedures or policies. AEMO has made every reasonable effort to ensure the quality of the information in this document but cannot guarantee its accuracy or completeness.

Accordingly, to the maximum extent permitted by law, AEMO and its officers, employees and consultants involved in the preparation of this document:

- make no representation or warranty, express or implied, as to the currency, accuracy, reliability or completeness of the information in this document; and
- are not liable (whether by reason of negligence or otherwise) for any statements or representations in this document, or any omissions from it, or for any use or reliance on the information in it.

Contents

Important notice	2
Purpose	2
Disclaimer	2
Current version release details	6
1. About this Guideline	7
1.1. Purpose and scope	7
1.2. Related policies and procedures	8
1.3. Completion of Model Acceptance Tests	8
2. Model acceptance principles	9
2.1. Scope	9
2.2. Model documentation and structure	11
2.3. Model initialisation and dynamic simulation requirements	16
2.4. Acceptance criteria during dynamic simulation	17
2.5. Wrapper-based RMS models	20
2.6. Model Acceptance Test checklist including pre-requisite information	22
3. Model Acceptance Tests	23
3.1. Pre-requisite information	23
3.2. Case studies for both IBR and synchronous plant	23
3.3. Additional case studies for IBR generation systems and integrated resource systems with low and high voltage ride-through function	49
3.4. Additional grid voltage tests for IBR operating at reduced energy source inputs	49
3.5. Additional case studies to verify minimum declared SCR that the IBR generation systems or integrated resource systems can sustain	50
3.6. Additional case studies for synchronous generators and synchronous condenser systems	51
3.7. Additional case studies for dynamic reactive support plant	53
3.8. Additional tests for IBRs with reactive power mode without active power production	54
3.9. Additional tests for integrated resource systems	54
3.10. Additional tests for South Australian Connections	54
3.11. Other technologies	54
3.12. Model integration into AEMO's OPDMS and PSCADTM network case	54
Appendix A. DMAT checklist	56
Appendix B. Frequently asked questions	65
B.1 FAQs added November 2021	69
Appendix C. Selected examples and issues	73
C.1 Other examples of deficient models	76
Abbreviations	78
Version release history	80

Tables

Table 1	DMAT due diligence and acceptance pathway	11
Table 2	Flat run, snapshot and initialisation test	2726
Table 3	Balanced fault – large disturbance test cases.....	2827
Table 4	Unbalanced fault – large disturbance test cases	29
Table 5	MFRT random event selection for EMTP model test.....	33
Table 6	MFRT random event selection for RMS model test.....	3433
Table 7	TOV test case	3534
Table 8	Voltage and Reactive Power (and/or PF) control reference step change test	3635
Table 9	Active Power Controller Reference step change test	38
Table 10	Grid frequency controller test	39
Table 11	Grid voltage response test.....	4241
Table 12	Grid oscillatory rejection test.....	4443
Table 13	Grid phase angle response test	4544
Table 14	SCR = 1: Active power reference change test.....	4645
Table 15	SCR=1- FRT Test	4645
Table 16	FRT Benchmarking for POC SCR and X/R Conditions	4847
Table 17	Input power source step change (for example, wind speed, irradiance)	4948
Table 18	Model source code, transfer function block diagrams, technical description, and complete parameter list.....	5655
Table 19	Evidence of type test (or otherwise, such as laboratory converter module test) FRT validation, evidence of low SCR capability, evidence of multiple FRT testing and validation including protective mechanisms	5756
Table 20	Model documentation, layout, and run time capabilities – requirements (cross check)	5857
Table 21	Required model output channels	6264
Table 22	List of minimum mandatory tests for self assessment (Continuation of DMAT Checklist)...	7274

Figures

Figure 1	Model Process Flow Diagram.....	21
Figure 2	An example test circuit for model acceptance testing	25
Figure 3	5% Voltage reference step test [pu]	3736
Figure 4	5% Grid voltage step response test [pu].....	37
Figure 5	Reactive Power (and/or PF) reference test [pu]	3837
Figure 6	Active Power Reference [pu].....	3938
Figure 7	Grid frequency test – overfrequency [Hz] (fast 4 Hz/sec (250 ms) ramp rate and frequency reaching 52 Hz over 3 seconds)	4039
Figure 8	Grid frequency test – underfrequency (fast 4 Hz/sec (250 ms) ramp rate and frequency change of 1 Hz/second over 3 seconds)	40
Figure 9	Grid voltage ramp response test [pu] (voltage ramped over 6 seconds)	4241
Figure 10	10% Grid voltage step response test [pu].....	4342
Figure 11	Extended dip grid voltage recovery test	4342
Figure 12	Oscillatory rejection tests [example of 1 Hz to 10 Hz in steps of 1 Hz per modulation]	4443
Figure 13	SCR = 1 Active power reference change test [pu]	4645
Figure 14	Step response simulations without limiter operation	5251

Figure 15 Step response simulations into UEL and OEL5352

Figure 16 PSSE and PSCAD benchmarking inconsistency and instability in the DQ reference frame
for an IBR plant.....7372

Figure 17 PSSE and PSCAD benchmarking results for one selected fault in this DMAT Guideline. D
axis current comparison. (The second plot shows zoomed in response of the “spike”
signal)7473

Figure 18 Active and Reactive Power benchmarking inconsistency for RMS quantities.....7473

Figure 19 PSCAD Example of the post fault response considering time step change in the proponent
provided model (existing connection in the NEM).....7574

Figure 20 An example of a modelled response for one unbalanced fault7675

Current version release details

Version	Effective date	Summary of changes
3.0	3 June 2024	Updates to reflect National Electricity Amendment (Integrating energy storage systems into the NEM) Rule 2021 No. 13.

Note: There is a full version history at the end of this document.

1. About this Guideline

1.1. Purpose and scope

AEMO has prepared this Guideline to explain how it assesses the accuracy, consistency and robustness of computer models used for power system analysis. This document explains the process for carrying out dynamic model acceptance tests (DMATs) for root mean square (RMS) and electromagnetic transient (EMT) type models¹. DMATs are necessary to provide confidence the model is usable and numerically robust, and represents the installed plant under reasonably expected operating conditions. The objectives of the acceptance tests described in this document are to determine the following:

- Robustness of the model for defined test conditions specified by upper and lower boundaries of system strength.
- Consistency and accuracy of PSS®E and PSCAD™/EMTDC™ modelled performance from the [manufacturer/Original Equipment Manufacturer/Generator/Integrated Resource Provider](#) provided validation, and consistency of PSS®E and PSCAD™/EMTDC™ modelled performance reflective of equivalent system strength conditions at the point of connection (POC) in the National Electricity Market (NEM) and the test scenarios in this Guideline.
- If the model information provided to AEMO and the network service provider (NSP):
 - Is fit for purpose in progressing with the power system connection studies.
 - Is acceptable for AEMO and the NSP's due diligence works, including application of models for AEMO's operational, planning, and power system assessment needs.
 - Meets AEMO's modelling requirements outlined in the *Power System Model Guidelines*².
 - Has documentation and structure that meets National Electricity Rules (NER) requirements, including for provision of data, source information, settings, and control diagrams.

It is essential to note that:

- **Model acceptance tests do not assess compliance of any given plant with performance or access standards at its connection point.**
- **Model acceptance does not indicate that models submitted for a particular connection project will meet the applicable compliance requirements³.**
- **The requirements for model validation following the connection or modification of a generating system [or integrated resource system](#) must still be complied with.**

¹ At present AEMO primarily uses PSS®E and PSCAD™/EMTDC™, respectively, for RMS and EMT studies.

² [See At power systems model guidelines 2023 published .pdf \(aemo.com.au\)https://aemo.com.au/Stakeholder-Consultation/Consultations/Power-System-Model-Guidelines-and-System-Strength-Impact-Assessment-Guidelines.](https://aemo.com.au/Stakeholder-Consultation/Consultations/Power-System-Model-Guidelines-and-System-Strength-Impact-Assessment-Guidelines)

³ AEMO or the relevant NSP may have specific requirements for an individual connection.

This document presents a systematic DMAT suite and the key criteria for dynamic model acceptance, including simulation case studies which the dynamic models will undergo for acceptance.

1.2. Related policies and procedures

In addition to the acceptance testing set out in this document, dynamic models and information provided must meet all requirements set out in the *Power System Model Guidelines*⁴, *Power System Design Data Sheets and Power System Setting Data Sheets*⁵, and the NER.

To further aid understanding of model application, please see the details outlined in Section 2 of the [Guidelines for Assessment of Generator Performance Standards Access Standard Assessment Guide](#)⁶.

1.3. Completion of Model Acceptance Tests

AEMO's costs of model acceptance testing will be based on the hourly rate for the required resources. The total cost and time can vary depending on model complexity and the quality of information provided by the vendor. Certain information required in this Guideline is for AEMO only and will not be included in model disclosures required under the NER. Such aspects include unencrypted source codes and detailed parameter lists/settings.

On completion of a DMAT, AEMO will inform the vendor of model acceptance, model rejection, or if improved models (or model settings) are required, for relevant purposes depending on the status of the [generating system project](#), for example:

- Assessment of Generator [or Integrated Resource Provider](#) Performance Standards.
- AEMO's due diligence.
- Registration.
- Model use for AEMO operations, planning, and congestion/constraint applications assessments.

⁴ See [power systems model guidelines 2023 published .pdf \(aemo.com.au\)](#).

⁵ See [power system design and setting data sheets 2023 published .xlsx \(aemo.com.au\)](#).

⁶ See [access-standard-assessment-guide-20190131.pdf \(aemo.com.au\)](#).

2. Model acceptance principles

2.1. Scope

2.1.1. Model types

The model acceptance testing discussed in this document applies to:

- Dynamic PSS®E models, and
- PSCAD™/EMTDC™ models.

2.1.2. Scope of tests

Plant items

The scope of this Guideline covers each primary plant item for which dynamic models have been provided independently. This includes, but is not necessarily limited to:

- For synchronous generating units (and synchronous condenser units where applicable), models and settings of:
 - Excitation system (automatic voltage regulator [AVR], exciter, power system stabilisers [PSS], and limiters) derived from the actual plant information, using a generic (or user-specific, if provided) synchronous machine model (with specific parameters).
 - Governor system.
- For inverter-connected technologies (for example, wind farms, solar farms, and/or battery systems), models and settings of:
 - Aggregated equivalent wind turbine model including central park level controller.
 - Aggregated equivalent solar inverter model including its park level controller.
 - Aggregated equivalent battery system including its central park level controller.
- Equivalent aggregate generating system or integrated resource system representation, if composed of various individual technologies, including the overall generating-system or integrated resource system controller respectively.
- For dynamic reactive support plant such as static ~~Var-var~~ compensator (SVC) and static synchronous compensator (STATCOM), models and settings of:
 - Main and auxiliary control systems for power electronic plant including its limiters and supplementary controls such as power oscillation damper (POD) and phase balancing.
 - Auxiliary control systems for any mechanically switched elements.
- For high voltage direct current (HVDC) links:
 - If intended as interconnectors, the DC link model and its settings with ~~a generic large (nearly infinite) generating system an ideal voltage source~~ connected at one end.
 - If intended as embedded DC links with generating systems and/or integrated resource systems connected to one or both ends, the DC link model with a generic (or specific, if

provided) model of the generating system(s) and/or integrated resource system(s) at one end or both ends (if applicable).

- If intended to interface islanded networks, for example DC-connected wind farms, the DC link model with a specific model of the wind farm.
- For all transformer models, saturation parameters shall be included in the model together with the test report (for example, type or factory tests)

For plant commonly used in combination with other plant (for example, specific wind turbine models and dynamic reactive support devices, or in combination with photovoltaic [PV] solar or battery systems), model testing would be used to assess potential model interactions (including the power system as well as model compatibility issues with any of the existing models).

For plant with several control or operation modes, the model acceptance will encompass all modes. Included in this category are, and not necessarily limited to:

- Central park level controller for each individual technology such as wind, solar, and battery systems or combination of various technologies, which can provide multiple control functions such as voltage control, frequency control, and power factor control.
- Generating-Production units with a changeover function between the star and delta connection modes for various power output levels.

Test application

The following model acceptance tests apply for models in line with AEMO's required simulation platforms:

- Tests bounded by low and relatively high short circuit ratio (SCR)⁷ conditions defined in this Guideline.
- Tests bounded by low and relatively high X/R conditions defined in this Guideline.
- Tests for System Strength Conditions taking into consideration proposed Connection Point characteristics.
- Test with very low SCR.
- Balanced Undervoltage – Fault Conditions.
- Unbalanced 1 Phase to Ground, 2 Phase to Ground, and Line-to-Line faults for PSCAD™/EMTDC™ models.
- Balanced Overvoltage Disturbances.
- Over and Under Frequency Injection Tests.
- Active Power Step (for example, Run-back), Voltage, and Power Factor (PF)/Reactive Power Step Tests.
- Step change to the input power source (for example, wind, irradiance)

⁷ SCR is a measure of the strength of the network to which the equipment is connected. This is defined as the ratio of the short circuit capacity of the grid at the point of common coupling (PCC) in megavolt amperes (MVA) to the nominal power at the PCC in megawatts.

- Voltage Step and Ramp tests.
- Dynamic response tests for abrupt voltage phase shifts.
- Test Run with a fault condition in large network for AEMO’s OPDMS PSS®E model and AEMO’s PSCAD™/EMTDC™ Network Model (performed by AEMO in addition to PSS®E tests that the Generator or Integrated Resource Provider may be undertaking themselves using AEMO’s OPDMS data, see Table 1) to ensure no suspect states, variables, satisfactory initial conditions, and no model interactions, as well as to test model adequacy for real-time operational and planning purposes.

Table 1 DMAT due diligence and acceptance pathway

Scope of Tests	Initial Screening and Assessment	Final Assessment and Acceptance
All SMIB tests involving PSS®E model and PSCAD™/EMTDC™	Proponent or NSP as agreed	AEMO
PSS®E OPDMS wide area model test	Proponent or NSP as agreed	AEMO
PSCAD™/EMTDC™ Wide Area Network Model	NSP	AEMO

2.2. Model documentation and structure

Proponents (that is, Generators or Integrated Resource Providers or Connection Applicants) are required to submit the following items as part of the model assessment submission. It is expected that all documentation provided will be consistent:

- Compiled model in PSS®E and PSCAD™/EMTDC™ and associated libraries.
- Corresponding model source codes in PSS®E (FORTRAN).
- Corresponding transfer function block diagrams
- Complete list of settings/parameters for both PSS®E and PSCAD™/EMTDC™ models
- Instructions on how the model should be set up and used.
- Validation reports⁸ (for both PSS®E and PSCAD™/EMTDC™) validating the model’s fault ride-through performance with the measurements for inverter based resource (IBR) technologies including:
 - Low voltage ride-through (LVRT) validation, balanced and unbalanced faults (PSCAD™/EMTDC™ model validation for unbalanced faults and balanced faults, and, PSS®E model validation for balanced faults).
 - Multiple LVRT validation/confirmation of capability.
 - Low SCR LVRT validation/confirmation of capability (for example, type test, Factory Acceptance Tests (FAT), module test, Hardware in the Loop (HIL) test).

⁸ As agreed with AEMO and where alternative examples may include and not limited to: Laboratory tests, Hardware in the Loop (HiL) tests for converter modules and specific functions and features, e.g. chopper limitations (ratings - temperature tests) for DFIG or FSFC type wind turbines in consideration of MFRT and so on.

- High voltage ride-through (HVRT) validation.

Model documentation and structure will be reviewed, and several main attributes will be assessed:

- The transfer function block diagram must include all functional controllers and physical plant that materially affects the performance of the model⁹.
- The model must meet the accuracy requirements specified in the *Power System Model Guidelines*. Prior to commencing the DMAT, the model validation report must be provided or justification of the model release by the vendor must be satisfactorily substantiated. Examples of the latter may include: Laboratory tests, Hardware in the Loop (HiL) tests for converter modules and so on. Following the plant energisation, the veracity of model accuracy for the site-specific settings must be verified through R2 testing including staged tests and events which are monitored and models validated by Generators [or Integrated Resource Providers](#), including through ongoing compliance obligations in consideration of power system events when they occur.
- The PSS®E and PSCAD™/EMTDC™ model responses are consistent for balanced events.
- The models of the controllers and items of plant must be easily identifiable.
- The model parameter values must reflect typical values appropriate for the actual equipment installed. The block diagram must show all model parameters and their value.
- The use of complete black-box type representation is not acceptable, and the model must at the very least show all primary design elements, their inputs and outputs, consistent with Power System Model Guideline. As an example, for DFIG (and full scale converter) type wind turbines, the model is expected to represent and have clear visibility of the machine, machine side converter, grid side converter, DC link, chopper (where used), rotor (machine side) and stator (grid side) connections, transformer and so on.
- The interconnection of the different functional controllers and the items of plant must be clearly shown.
- Control systems with several discrete states or logic elements may be provided in flow chart format if a block diagram format is not suitable.
- Model parameter values that are intended to be (or can be) externally adjusted (those explicitly in PSS®E dynamic data file) must be clearly identified in the model block diagram.
- The model block diagram and flow charts (where found reasonably applicable) must represent the corresponding model source code¹⁰ and be verifiable.
- The model inputs and outputs shown in the transfer function block diagram representation must match those indicated in the model datasheet tables.
- For PSS®E, the state variables shown in the transfer function block diagram representation must match those indicated in the model datasheet tables.

⁹ Included in this category are the central park level controllers that schedule active and reactive power across the IBR plant.

¹⁰ It is also expected that the functional block diagrams provided with the Power System Design and Setting Data Sheets for a specific generating system [or integration resource system](#) connection will match these diagrams, although the parameter values might differ to reflect particular connection point performance requirements.

- Model documentation and transfer function block diagram representation must be provided necessary to derive the corresponding linear small-signal model of the equipment.
- Dynamic data must be provided as ‘per unit’ quantities on the machine megavolt amperes (MVA) base unless otherwise agreed with AEMO.
- The maximum duration of the dynamic simulation run for which the model accuracy is proven must be clearly stated.
- For wind-up and anti-wind-up proportional integral (PI) controllers, details of the controller (including any potential dead-band and saturation) must be shown in the transfer function block diagram representation.
- For IBR technologies, parameters must be accessible in the main software interface for online monitoring and possible changes during the simulation, as outlined in the *Power System Model Guidelines*. The following signals, some which may be additional to the *Power System Model Guidelines*, shall be provided:
 - Active power at LV and connection point terminals.
 - Reactive power at LV and connection point terminals.
 - Total current at LV and connection point terminals.
 - Active current at LV terminals and connection point terminals¹¹.
 - Reactive current at LV terminals and connection point terminals^{11,214}.
 - Active current reference at LV terminals.
 - Reactive current reference at LV terminals.
 - Negative sequence voltage at LV and connection point terminals.
 - Negative sequence current at LV and connection point terminals.
 - Negative sequence current reference at LV terminals.
 - RMS voltage at LV terminals.
 - Active and reactive power, voltage for the DC Link
 - All protection trip flags (output channels) including their settings.
 - Applicable set-points including¹²:
 - Active power set-point.
 - Frequency set-point.
 - Voltage set-point.
 - Reactive power set-point.

¹¹ For the purpose of LVRT and HVRT assessment, the actual per unit converter current related to the connection point shall be used, and not the capability established in S5.2.5.1 (which refers to operating voltage range of 90% to 110%). For IBR utilising d and q axis control quantities, d and q axis voltages and currents shall be provided to verify the measured power quantities.

¹² Set-points must be run-time settable without the need for the model to be re-compiled.

- Power factor set-point.
- LVRT and HVRT activation/deactivation (flag if used).
- Reactive current injection during the fault.
- Additional requirements for wind turbines:
 - Pitch angle.
 - Wind speed.
 - Generator rotor speed.
 - Mechanical torque/power.
 - Aerodynamic torque/power.
- Output of phase lock loop (PLL) (measured frequency) where PLL is used¹³.
- Output of frequency measurement from the Plant Controller.
- For PSCAD™/EMTDC™, the plant controller and converter controller model must have all applicable settings available to AEMO as either, drop down selection of settings, or a separate user parameter file, showing all parameters, allowing it to be linked during the simulation run. These (complete) parameters files may be separated from the Releasable User Guide.
- The minimum design value of the SCR for inverter-based resources (IBR) must be documented, and evidence provided to substantiate it. As the model will be assessed independent of specific connection projects, the SCR must be defined at the equipment terminals (for example, medium voltage [MV] terminals) rather than the point of common coupling (PCC). Statements defining dependence on external electrical balance of plant design or defining SCR capability depending on the selection of parameters, will not be accepted, unless evidence is provided to state the actual tested and validated equipment, including characteristics of its failure modes under low SCR conditions (an example could be converter instability, in which case the magnitude, nature, and severity of oscillations or responses is to be showcased to support limitations of technology against low SCR conditions).
- The validation of Multiple Fault Ride-Through (MFRT) must be documented, and relevant protective mechanisms provided in the model, together with the settings defining pick up levels, time delays, and activations; for example, refer to Section 2.4.
- For IBR generating systems or integrated resource systems-generation technologies, the model aggregation methodology proposed must be clearly specified.
 - The aggregation method must not restrict access to the inverter terminals (LV side of the turbine transformer).

¹³ PLL settings and outputs must be provided for all frequency (phase) measuring devices, especially where different frequency meters are used. Examples include PLL use (frequency estimation) for protective functions, PLL use for control functions, PLL use on wind turbine models on a machine side as well as the grid side converter. Where PLL is not used, a technology specific measurement and settings shall be provided and made available; for example, for – grid forming technologies.

- The use of full feeder representation for one or more feeders is not considered good industry practice due to the accompanying computational burden. It should not be used unless agreed with AEMO to be acceptable.
- The model must be written and prepared using good electricity industry practice and good model writing practices for the relevant software. For PSS@E, this would include:
 - Execution of the DOCU command must show all model states, outputs, and constants that are observable/adjustable externally. The output format of these commands must be consistent with the format of dynamic data.
 - Execution of dynamic data documentation commands must not result in model crashing.
 - The model representation of the actual plant does not have dummy buses (for example, for control or flow monitoring purposes). The model controls are also consistent with the actual plant; for example, if one plant controller is used onsite, then the model shall be based on one plant controller as well.
 - Models which include calls into either of the CONEC or CONET subroutines are not acceptable. In PSS@E; this approach would require users to make a fresh compilation every time the network configuration changes, so a dedicated FORTRAN compiler is needed for each user.
 - Avoid using identical names for models of similar structure where the number of one of the CONs, ICONs, VARs, or STATES is different between the two models.
 - The model should comprise a single executable file for each physical plant. Use of auxiliary or linking files is discouraged.
 - The model should be initialised using load flow result (and AEMO's system snapshot when the model is used in the OPDMS production environment) as the initial condition, and not relying on scripts.

For PSCAD™/EMTDC™, this would include:

- Model parameter values for PSCAD™/EMTDC™ must be provided in a file format that allows linking (or use) for dynamic execution run without the need to recompile. Examples could include provision of model parameters via drop down menus, settings configuration (or text files) file(s) called upon model execution run.
- Change in model settings or *re-build* of the model in PSCAD™ must not require manual effort to copy additional configuration files into the *Build* folder.
- Model libraries must be project specific and not clash with any existing models (for example, from the same vendor).
- Model definitions are desired to be embedded inside the project, instead of a separate library file.
- Models must be provided with Voltage (PF and/or Reactive Power), and Active Power References as explicit data signals (variables, not constants).
- Model debug signals must be provided including the complete list, naming and purpose of these signals.

- Specific feeders or parts of the plant which may be subject to disconnection from control schemes must be modelled explicitly, unless otherwise agreed with AEMO.
- Models must not be provided with the following dependencies:
 - Predefined X/R or system strength MVA rating input into the plant controller.
 - Fixed frequency of the SLACK machine as the input to the controller or IBR (that is, the model must take the actual frequency of the network or the system frequency should be computed by its frequency estimator).
- Model structure is desired to be contained within its own module block including its plots.
- Model support files (for example, reference to DLL, FORTRAN, LIB) must be called via local file path references rather than complete/absolute paths.
- Models must be provided with scalable transformer tap settings (for example, slider or similar) including the max and min tap range limits. Where used, transformer AVR shall be provided with an option to disable/enable its use including the setting for time delays and activation.
- Models must have a setting to allow the following without the user needing to manually apply changes:
 - Simulations with different number of inverters or generating production units.
 - Change of base MVA (including reactive power base for the Plant controller or active power controller).
- Model aggregate representation must be equivalent to the PSS®E representation of the same.

2.3. Model initialisation and dynamic simulation requirements

- Models must be initialised successfully for the entire intended plant operating range. The model operating range must be consistent with the actual equipment design, in particular, with respect to the following:
 - The entire range of active power.
 - The entire range of reactive power/power factor (including limits of reactive power generation and consumption).
 - Operating range of connection point voltage between 90% and 110% which takes into account primary equipment limitations.
- Currently AEMO applies and requires the model to support the following PSS®E solution parameters:
 - Acceleration Factor 0.2.
 - Tolerance 0.0001.
 - Frequency Filter 0.008.
 - Timestep (DELTA) 0.001.

- Time step variation 0.001 to 0.01 s.
- ITER variation 250-600.
- Network Frequency Dependence.
- For PSS®E, the derivative of all state variables should be less than 0.0001 during initialisation.
- For PSCAD™/EMTDC™ models, steady state jitter (jitter is not an oscillatory response in a sustained way) is tolerable in the range of less than 0.1% for both the single machine case and when integrated into the wide area network model.
- PSCAD™/EMTDC™ models are desired to support 10 microseconds (or greater) simulation time step. In cases where various other time steps may be used, the vendor must confirm validity/accuracy of the model and evidence provided to substantiate it, i.e. where lower time steps are used, the vendor must provide justification/evidence as to why higher simulation time steps cannot achieve the same level of accuracy.
- PSCAD™/EMTDC™ models must have snapshot capability and must initialise within 3 seconds of simulation time¹⁴. The model must be able to run and be stable up to 5 minutes of simulation time as outlined in the *Power System Model Guidelines*.

2.4. Acceptance criteria during dynamic simulation

Dynamic models provided must have the following characteristics:

- Voltage, frequency, and active and reactive power remain constant for dynamic simulation runs with no disturbance.
- Models do not interfere with the operation of other dynamic models.
- Models are numerically robust for dynamic simulation runs of up to 5 minutes.
- The numerical integration time step should be kept under 20-25% of the shortest time constant in the process being simulated. For acceptable numerical integration time steps, please refer to Section 4.3 of the *Power System Model Guidelines*.
- Time constants smaller than the minimum acceptable numerical integration time step should be avoided.
- Model outputs in terms of the voltage, frequency, and active and reactive power should be reasonably constant and consistent when doubling and halving the recommended time step. Actual firmware time step must be stated for all PSCAD™/EMTDC™ models, and differences between changes in simulation time steps (if time step is below and different from the 10 micro-seconds required for PSCAD™/EMTDC™ studies) must be documented together with evidence of model consistency or its limitations, in particular for changes in references, LVRT, HVRT, or step/ramp/phase change applications required to be tested in this Guideline.
- Must be numerically stable for a wide range of grid SCR and grid and fault X/R ratio.

¹⁴ To meet initialisation times, availability of load flow conditions (for example voltage magnitude and phase angle) for the point of connection of the plant may be assumed.

- Must be numerically stable for unity, lagging, and leading power factors as well as the full range of active power output (for example, to ensure all system snapshot conditions can be captured without such a model numerically crashing or being unstable).
- When the simulated response exhibits unusual performance characteristics several seconds after removal of the disturbance, provision of off-site test results (for example, hardware in the loop or type test) for identical equipment is necessary to demonstrate that the actual equipment will perform the same way.
- Models must work for a range of the dynamic simulation parameters rather than for specific settings.
- Wind turbine models are required to include the main physical equipment details, such as the shaft, inertia, stiffness, and mass(es) representation of the main rotor/generator, including any damper activations during or in the post fault recovery periods. Equally, evidence of tower and electrical drive train oscillations are required to substantiate the accuracy of the model.
- To avoid excessive simulation burden when integrating models into AEMO OPDMS (PSS@E) and Dynamic Security Analysis (DSA) tools, the minimum permissible values of the numerical integration time step and acceleration factors are 1 ms and 0.2 respectively. Currently AEMO applies 0.008 for the frequency filter requirement and the model is expected to work from 0.008 up to an including the default setting of 0.04.
- Model benchmarking (and assessment against consistency and/or accuracy) is undertaken for the following PSS@E and PSCAD™/EMTDC™ modelled responses:
 - 3 phase faults and voltage disturbances.
 - Overvoltage events.
 - Reference changes.
 - Phase shifts¹⁵ and/or frequency responses.
 - Application of ramps and step responses.

The acceptance criteria are based on demonstration of consistency in RMS responses and *Power System Model Guidelines* accuracy requirements¹⁶ and:

- The **Generator**/model does not reduce total current delivered to the Grid during undervoltage, that is, 3 phase disturbance.
- The **Generator**/model maintains its active current injection as close as possible to the in-fault retained voltage levels (that is, not blocking the inverter).
- The **Generator** model has no negative active power (driven by loss of control or poor modelling- numerical artefacts) during the disturbance unless negative power swings apply

¹⁵ Application of phase shifts is expected to meet accuracy/consistency requirements. Where differences are observed (and they may be expected with the use of PSCAD™/EMTDC™ models vs PSS@E implementation), detailed control block diagrams (or the implemented source code) and applicable settings (including the PLL implementation for IBR) shall be provided to substantiate inconsistencies.

¹⁶ Note that 'oversimplification' of control coded capabilities (for example, due to minimisation of coding effort with FORTRAN) in PSS@E software may not be accepted if it is reasonably implementable otherwise.

to synchronous condenser or synchronous generator systems for which detailed assessments, design and details of protective elements must be considered and provided. Consideration is also given to equipment design ratings or specifications of IBR¹⁷.

- The **Generator** model is numerically stable.
- The **Generator**/model appears reasonably tuned in its active and reactive current responses for POC SCR and X/R conditions acknowledging that settings differences (and in turn the impact on performance difference) could apply between strong and weaker connections.

Exceptions may be provided for fast transients on a case-by-case basis considering very short time periods (for example, one half to one power frequency cycle) immediately following clearance of the disturbance, taking into consideration that the magnitude and duration of deviation is reasonable, and results have consistency between the RMS and electromagnetic transient (EMT) models.

For unbalanced faults, acceptance criteria are based on evaluation of performance for stability purposes, taking into consideration negative sequence voltage and negative sequence current injection from the **Generatorproduction unit**, as well as the ability to deliver required total current and reactive current injection with sufficient rise and settling times. Observation of current and monitoring of all 3 phases individually is used to ensure the **Generator**/model control functions:

- Do not materially affect the unfaulted phase(s).
- Do provide for negative sequence voltage reduction during an unbalanced event, and is able to maintain total current during the fault.
- Control the in-fault active current in proportion to the retained voltage (also applicable to balanced 3 phase faults).
- Does not limit its current injection due to lack of negative sequence control functionality.

Considering various SCR and X/R conditions, certain responses may result in sub-synchronous oscillatory instability indicating lack of control capability or control interaction. In these instances, while AEMO may accept differences in PSS®E and PSCAD™/EMTDC™, such results will not be accepted unless it can be determined which control system and which parameters influence the excitation or instability, or if such responses are due to inadequacies of the model numerical performance itself or the actual limitations of the firmware/plant.

When the simulated response exhibits unusual performance characteristics, for example, after removal of the disturbance, provision of off-site test results (for example via hardware in the loop or type tests) for identical equipment is necessary to demonstrate that the actual equipment will perform the same way.

- Modelled responses and evidence to justify change in control parameters are obtainable to resolve the control responses, without compromising requirements for delivery of total active and reactive currents during steady state and disturbance events (unless exempted).

¹⁷ For example, including IBR control – and controlled signal reference tracking capability, PLL capability including adequacy of settings, severity of the contingency studied at inception, during and on clearance of such, magnitude and duration of the response, LVRT type test validation report.

- PSCAD™/EMTDC™ models must have simulation speed of no worse than 90 (60 seconds or less is preferable) real time seconds per simulation second¹⁸.
- PSCAD™/EMTDC™ models initialise within required 3 seconds for all operating conditions including a variety of SCR and X/R conditions.
- PSCAD™/EMTDC™ models are expected to fail (trip, without crashing the simulation) SCR test of 1.0 at full power (unless evidence provided otherwise).
- PSCAD™/EMTDC™ models include all output channels as indicated in Table 4 of *Power System Model Guidelines* and additional signals in this Guideline.
- Models have necessary protection elements (for example, in addition to overvoltage, undervoltage, overfrequency, and underfrequency) for multiple fault ride-through assessment. Other protection aspects for single as well as multiple contingencies, for example, include rotor speed protection for wind turbines, pole slip for synchronous machines, dump resistor heating monitoring (function of voltage and current, dip, duration), Volt/hertz (Hz) relays, and reverse power protection.
- Models must work for a range of the dynamic simulation parameters rather than for specific settings (as an example, this includes different time steps, iteration, and acceleration factors applicable in PSS®E where only single DYR file is used and enables simulations runs with different simulation time steps).

2.5. Wrapper-based RMS models

Currently, AEMO accepts the source code in FORTRAN for PSS®E software. The use of other source code formats, or wrapper-based models, is generally not feasible for several reasons, including, but not limited to:

- Incompatibility with systems, making it difficult or impossible for AEMO to meet its system security responsibilities and regulatory obligations.
- Significant additional costs and resourcing involved in maintaining non-FORTRAN models.
- Prohibitive licensing requirements.

Proponents or vendors who still wish to use source codes written in other formats are advised to contact AEMO to discuss feasibility at least 12 months before intended use in any model submission under the NER. AEMO will consult with the proponent or vendor to determine whether a detailed feasibility assessment can be undertaken in relation to the proposed model.

If AEMO agrees to conduct a feasibility assessment, this must be successfully completed before model submission and DMAT could occur. The assessment stages are illustrated below in the ***Model Process Flow Diagram***.

¹⁸ It is recommended to test simulation speed on a 2.8GHz processor or equivalent machine.

Figure 1 Model Process Flow Diagram

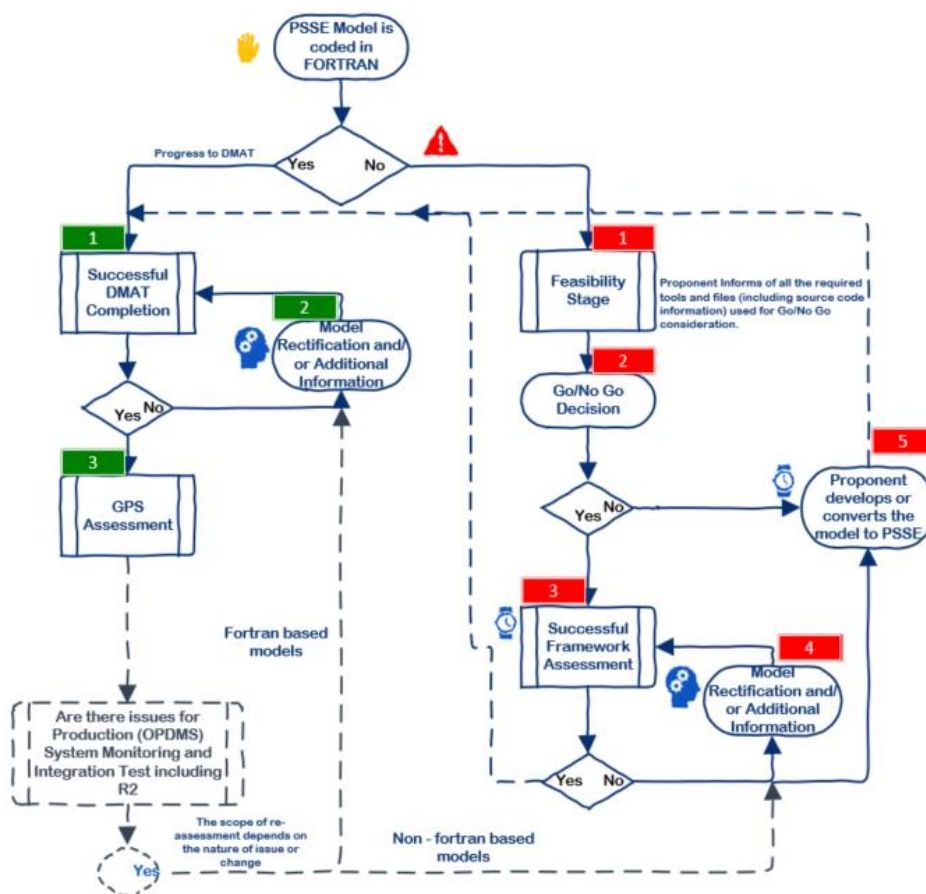

A feasibility assessment for an alternative to FORTRAN source code will add delay and cost to your project, and may ultimately be unsuccessful. Proponents and vendors should also note and carefully consider the following¹⁹:

- C (or C++) codes (for example, machine generated by Matlab Coder) are not accepted as source code.
- Model assessments require provision of all source code information to AEMO. The proponent will be responsible for the costs of any additional licences (toolboxes) AEMO needs for its assessment.
- The model must be integrable into a single NEM DLL file (with all other AEMO source code information) where other models of such type may also be present. Use of additional and external executables, batch files, C codes, python codes, etc. is not acceptable.
- Assessment timeframes cannot be guaranteed. As a guide, it may take up to 12 months from the time all required information is complete and verified. AEMO fees will be charged at hourly rates plus cost recovery for specialist resources.

¹⁹ AEMO can provide an additional list of requirements for consideration.

- There can be no assurance that the assessment will result in acceptance of the model, or that it will subsequently pass DMAT testing. This will necessitate re-coding of models into FORTRAN, requiring repeat of all system studies, due diligence, benchmarking, RUGs etc., in addition to DMAT assessment, with associated delay to project commitment.
- If the model is accepted, ongoing conditions will apply to ensure AEMO is kept whole for licensing costs and additional resourcing associated with model maintenance.

2.6. Model Acceptance Test checklist including pre-requisite information

To assist Generators or Integrated Resource Providers (or Connection Applicants, Intending Participants) in the preparation for Model Acceptance Testing:

- Appendix A1 includes a checklist of items and information required to be provided to AEMO with your submission.
- Appendix A2 lists the minimum self-assessment tests to be completed prior to submission.

3. Model Acceptance Tests

3.1. Pre-requisite information

Prior to commencing MATs, pre-requisite information requirements must be satisfied.

3.2. Case studies for both IBR and synchronous plant

In summary, the general MATs required can be summarised as follows:

- Fault disturbance tests with:
 - Three-phase-to-ground fault scenarios [PSS®E and PSCAD™/EMTDC™ models].
 - Single-phase-to-ground fault scenarios [PSCAD™/EMTDC™ models].
 - Two phase-to-ground fault scenarios [PSCAD™/EMTDC™ models].
 - Phase-to-phase (no ground) faults [PSCAD™/EMTDC™ models].
 - Multiple FRT disturbances [PSS®E and PSCAD™/EMTDC™ models].considering various factors such as:
 - Grid SCR.
 - Grid X/R ratio.
 - Voltage dip with Fault Impedance.
 - Fault duration.
 - Pre-fault active power at the POC.
 - Pre-fault reactive power at the POC.
 - Application of Overvoltage disturbance [PSS®E and PSCAD™/EMTDC™ models] including resilience to phase shifts.
- Non-fault disturbance tests [PSS®E and PSCAD™/EMTDC™ models]:
 - Step response test on active power set-point [generating system/[integrated resource system](#)-plant controller].
 - Step response test on reactive power set-point and/or power factor [generating system/[integrated resource system](#)-plant controller].
 - Step response test on voltage set-point [generating system/[integrated resource system](#)-plant controller].
 - Step response test on grid voltage magnitude.
 - Ramp response test on grid voltage magnitude change.
 - Rate of change of grid frequency test. (Note that for all cases the grid frequency is increased and decreased to the extreme frequency excursion tolerance limits and restored to 50 Hz again.)

- Step response test on grid voltage angle equal to $\pm 40^\circ$ (and up to $\pm 60^\circ$).

The plotting channels used depend on the equipment, but as a minimum the following quantities will be plotted for all equipment at their terminals and POC:

- Active current.
- Active current reference (for IBR plant).
- Reactive current.
- Reactive current reference (for IBR plant).
- Negative sequence voltage.
- Negative sequence current.
- Negative sequence current reference (for asynchronous plant, where used).
- LVRT and HVRT activation and deactivation flag (where used).
- Total current.
- Active power.
- Reactive power.
- Rotor speed (excluding solar and battery systems).
- For Doubly Fed Generators (DFIG), both the generator (stator) and rotor quantities including the inverter outputs where inverters are used.
- Magnitude of terminal voltage.
- Phase angle of terminal voltage.
- Per phase RMS voltage.
- Grid frequency (for example, computed by the plant controller, PLL output, [generating production](#) unit terminals).

Additional plotting channels may be used or required for assessment of each specific type of equipment or technology.

3.2.1. Application of faults – voltage dips via short circuit impedance – labelled by Zf

The MATs that need to be carried out are outlined in this section.

As examples, the test circuits used for [IBR generation systems or integrated resource systems variable generation](#) and synchronous generation technologies are shown in [Figure 2\(a\) and 2\(b\)](#) [Figure 1\(a\) and Figure 1\(b\)](#) respectively.

In Figure 2(a) and 2(b), the network slack bus is an infinite bus where the voltage magnitude and voltage angle are determined by an ideal voltage source being the reference node and balancing node. The unit and substation transformer voltages provided are example values and can vary according to the nominal values of the particular equipment. The substation transformer impedance shown in [Figure 2\(a\)](#) [Figure 1\(a\)](#) represents two parallel connected transformers.

Ignoring the effect of the generating system or integrated resource system current injection, referring to Equation (1), with the application of a network fault the remaining voltage, U_{dip} can be calculated as a function of fault impedance Z_f , system impedance Z_s , and source voltage V_s based on a simple voltage divider circuit theory.

Equation (1)
$$U_{\text{dip}} = V_s \cdot \frac{Z_f}{d \cdot Z_s + Z_f}$$

where d is a variable which allows varying fault distance with respect to the generating production unit.

Note that U_{dip} as the remaining voltage that appears when zero in-feed is provided by the generating production unit for which the model is being tested.

Rearranging (1) and assuming V_s equal to 1 pu the fault impedance can be calculated as:

Equation (2)
$$Z_f = d \cdot Z_s \cdot \frac{U_{\text{dip}}}{1 - U_{\text{dip}}}$$

Equation (2) implies that the fault impedance can be determined as a function of the predefined residual voltage at the fault location.

Figure 2 An example test circuit for model acceptance testing²⁰

(a) *Wind farm model acceptance set-up*

²⁰ For tests in this DMAT, a value of $d=1$ applies (unless specified otherwise) where the value of Z_f is varied to create different applied fault voltage levels at U_{pcc} – point of connection voltage, and in general this shall not limit the application of faults for different locations (different values of d) along the transmission circuit. Depending on the connection point characteristics, application of grid faults may be carried out at an agreed location for which model acceptance and benchmarking is carried out. Where subsets of tests appear (example tests 97-120, 149-152, 155-158 etc), these can be marked as tests “a” to “c” and so on.

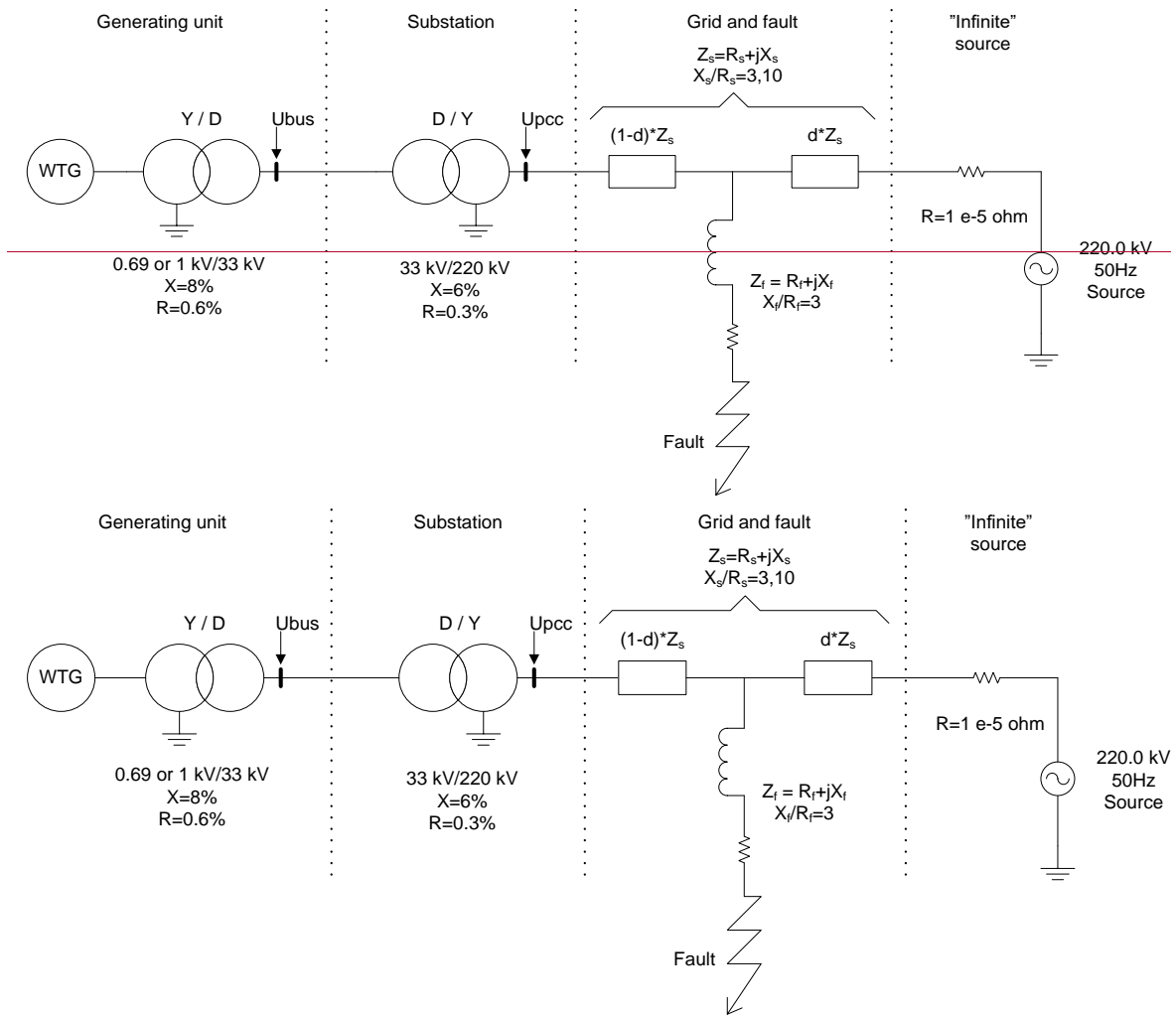

(b) Synchronous generator model acceptance set-up

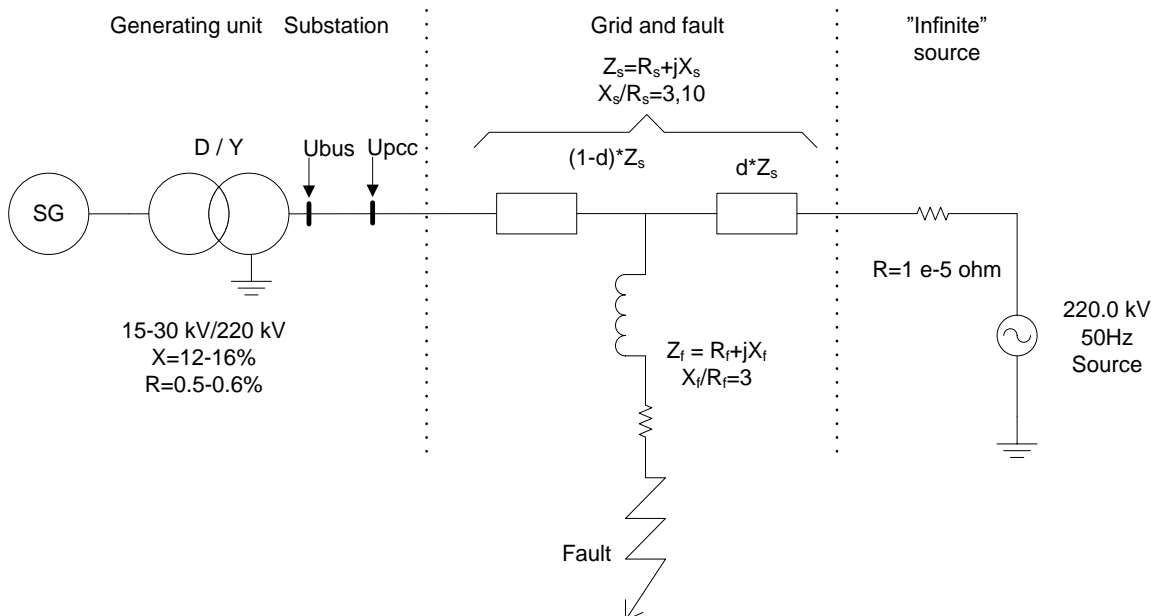

3.2.2. Required model performance time step

For DMATs referred to in this document, the model (including benchmarking) is required to perform within accuracy bands specified in the *Power System Model Guidelines*, and the following time steps:

- 1 ms for PSS@E models.
- 10 microseconds or higher value for PSCAD™/EMTDC™ models is desired. Where smaller time steps are used, the vendor shall provide justification/evidence as to why higher simulation time steps cannot achieve the same level of accuracy.

3.2.3. Pre-requisite tests – single machine infinite bus (SMIB) flat run [PSCAD™/EMTDC™ models]

Table 2 Flat run, snapshot and initialisation test²¹

Test	Test duration	Purpose	Comment	SCR	X/R	Active Power [pu]
0.1	300 seconds (s)	Flat Run and memory leak test (test performed with 'Store feed forward signals' enabled)	3 times consecutive flat run and results comparison without disturbance (Results are to be observed identical in all cases)	POC (5 – optional SCR)	POC (6 – optional X/R)	1
0.2	300 seconds (s)	Flat Run and memory leak test (test performed with 'Store feed forward signals' disabled)	3 times consecutive flat run and results comparison without disturbance (Results are to be observed identical in all cases and with the test 0.1)	POC (5 – optional SCR)	POC (6 – optional X/R)	1
0.3	300 s	Flat Run Test at lower than maximum output		POC (5 – optional SCR)	POC (6 – optional X/R)	0.05
0.4	5 s	Snapshot and Initialisation Test	Snapshot expected at 3 seconds following successful initialisation	POC (10 – optional SCR)	POC (6 – optional X/R)	1
0.5	5 s	Snapshot and Initialisation Test	Snapshot expected at 3 seconds following successful initialisation	POC (3 – optional SCR)	POC (6 – optional X/R)	1

²¹ For relevance to the connection point, these tests are recommended to consider equivalent details of the connecting system impedance, whilst maintaining optional tests for robustness purposes at different SCR and X/R ratios. Tests 0.4 and 0.5 are identical if same SCR and X/R values are used and thus need not be repeated.

3.2.4. Balanced fault – large disturbance test cases [PSS®E and PSCAD™/EMTDC™ models]

Note: The table below assumes lowest SCR value of 3. In the event the SCR values are expected to be lower at the generating system’s or integration resource system’s connection point, then the expected SCR values for system normal and the most severe credible contingency should be used²². (d=1 in all cases).

Table 3 Balanced fault – large disturbance test cases

Test	Fault duration [s]	Fault type	Fault impedance Z_f [pu]	SCR	X/R	Active Power [pu]	Reactive Power [pu]
1.	0.43	3PHG	Zf=0	10	14	1	0
2.	0.43	3PHG	Zf=0	10	14	1	-0.3
3.	0.43	3PHG	Zf=0	10	14	1	0.3
4.	0.43	3PHG	Zf=0	3	14	1	0
5.	0.43	3PHG	Zf=0	3	3	1	-0.3
6.	0.43	3PHG	Zf=0	3	3	1	0.3
7.	0.43	3PHG	Zf=0	10	14	0.05	0
8.	0.43	3PHG	Zf=0	10	14	0.05	-0.3
9.	0.43	3PHG	Zf=0	10	14	0.05	0.3
10.	0.43	3PHG	Zf=0	3	14	0.05	0
11.	0.43	3PHG	Zf=0	3	3	0.05	-0.3
12.	0.43	3PHG	Zf=0	3	3	0.05	0.3
13.	0.43	3PHG	Zf=Zs	10	14	1	0
14.	0.43	3PHG	Zf=Zs	10	14	1	-0.3
15.	0.43	3PHG	Zf=Zs	10	14	1	0.3
16.	0.43	3PHG	Zf=Zs	3	14	1	0
17.	0.43	3PHG	Zf=Zs	3	3	1	-0.3
18.	0.43	3PHG	Zf=Zs	3	3	1	0.3
19.	0.43	3PHG	Zf=Zs	10	14	0.05	0
20.	0.43	3PHG	Zf=Zs	10	14	0.05	-0.3
21.	0.43	3PHG	Zf=Zs	10	14	0.05	0.3
22.	0.43	3PHG	Zf=Zs	3	14	0.05	0

²² These are model robustness tests. It is noted that the assumed SCR (and X/R) range may not be credible for certain parts of the network.

Test	Fault duration [s]	Fault type	Fault impedance Z_f [pu]	SCR	X/R	Active Power [pu]	Reactive Power [pu]
23.	0.43	3PHG	$Z_f=Z_s$	3	3	0.05	-0.3
24.	0.43	3PHG	$Z_f=Z_s$	3	3	0.05	0.3
25.	0.5	3PHG	$Z_f=2xZ_s$ [Udip= \sim 0.7pu]	10	14	1	0
26.	0.5	3PHG	$Z_f=2xZ_s$ [Udip= \sim 0.7pu]	10	14	1	-0.3
27.	0.5	3PHG	$Z_f=2xZ_s$ [Udip= \sim 0.7pu]	10	14	1	0.3
28.	0.5	3PHG	$Z_f=2xZ_s$ [Udip= \sim 0.7pu]	3	14	1	0
29.	0.5	3PHG	$Z_f=2xZ_s$ [Udip= \sim 0.7pu]	3	3	1	-0.3
30.	0.5	3PHG	$Z_f=2xZ_s$ [Udip= \sim 0.7pu]	3	3	1	0.3
31.	0.5	3PHG	$Z_f=2xZ_s$ [Udip= \sim 0.7pu]	10	14	0.05	0
32.	0.5	3PHG	$Z_f=2xZ_s$ [Udip= \sim 0.7pu]	10	14	0.05	-0.3
33.	0.5	3PHG	$Z_f=2xZ_s$ [Udip= \sim 0.7pu]	10	14	0.05	0.3
34.	0.5	3PHG	$Z_f=2xZ_s$ [Udip= \sim 0.7pu]	3	14	0.05	0
35.	0.5	3PHG	$Z_f=2xZ_s$ [Udip= \sim 0.7pu]	3	3	0.05	-0.3
36.	0.5	3PHG	$Z_f=2xZ_s$ [Udip= \sim 0.7pu]	3	3	0.05	0.3

3.2.5. Unbalanced fault – large disturbance test cases [PSCAD™/EMTDC™ models]

Note: The table below assumes lowest SCR value of 3. In the event the SCR values are expected to be lower at the generating system's or integration resource system's connection point, then the expected SCR values for system normal and the most severe credible contingency should be used. (d=1 in all cases).

Table 4 Unbalanced fault – large disturbance test cases²³

Test	Fault duration [s]	Fault type	Fault impedance Z_f [pu]	SCR	X/R	Active Power [pu]	Reactive Power [pu]
37.	0.43	2PHG	$Z_f=0$	10 [and POC SCR]	14 [and POC X/R]	1	0
38.	0.43	2PHG	$Z_f=0$	10	14	1	-0.3
39.	0.43	2PHG	$Z_f=0$	10	14	1	0.3
40.	0.43	2PHG	$Z_f=0$	3	14	1	0
41.	0.43	2PHG	$Z_f=0$	3	3	1	-0.3

²³ While not explicitly indicated, AEMO may undertake any of these tests at POC specific conditions taking into account different PF operating ranges. A minimum set of POC tests is outlined to capture performance or limitations for different unbalanced faults and different active power levels. For line to line faults, impedance values refer to ground.

Test	Fault duration [s]	Fault type	Fault impedance Zf [pu]	SCR	X/R	Active Power [pu]	Reactive Power [pu]
42.	0.43	2PHG	Zf=0	3	3	1	0.3
43.	0.43	2PHG	Zf=0	10 [and POC SCR]	14 [and POC X/R]	0.05	0
44.	0.43	2PHG	Zf=0	10	14	0.05	-0.3
45.	0.43	2PHG	Zf=0	10	14	0.05	0.3
46.	0.43	2PHG	Zf=0	3	14	0.05	0
47.	0.43	2PHG	Zf=0	3	3	0.05	-0.3
48.	0.43	2PHG	Zf=0	3	3	0.05	0.3
49.	0.43	2PHG	Zf=Zs	10 [and POC SCR]	14 [and POC X/R]	1	0
50.	0.43	2PHG	Zf=Zs	10	14	1	-0.3
51.	0.43	2PHG	Zf=Zs	10	14	1	0.3
52.	0.43	2PHG	Zf=Zs	3	14	1	0
53.	0.43	2PHG	Zf=Zs	3	3	1	-0.3
54.	0.43	2PHG	Zf=Zs	3	3	1	0.3
55.	0.43	2PHG	Zf=Zs	10 [and POC SCR]	14 [and POC X/R]	0.05	0
56.	0.43	2PHG	Zf=Zs	10	14	0.05	-0.3
57.	0.43	2PHG	Zf=Zs	10	14	0.05	0.3
58.	0.43	2PHG	Zf=Zs	3	14	0.05	0
59.	0.43	2PHG	Zf=Zs	3	3	0.05	-0.3
60.	0.43	2PHG	Zf=Zs	3	3	0.05	0.3
61.	0.43	1PHG	Zf=0	10 [and POC SCR]	14 [and POC X/R]	1	0
62.	0.43	1PHG	Zf=0	10	14	1	-0.3
63.	0.43	1PHG	Zf=0	10	14	1	0.3
64.	0.43	1PHG	Zf=0	3	14	1	0
65.	0.43	1PHG	Zf=0	3	3	1	-0.3
66.	0.43	1PHG	Zf=0	3	3	1	0.3
67.	0.43	1PHG	Zf=0	10	14 [and POC X/R]	0.05	0

Test	Fault duration [s]	Fault type	Fault impedance Zf [pu]	SCR	X/R	Active Power [pu]	Reactive Power [pu]
				[and POC SCR]			
68.	0.43	1PHG	Zf=0	10	14	0.05	-0.3
69.	0.43	1PHG	Zf=0	10	14	0.05	0.3
70.	0.43	1PHG	Zf=0	3	14	0.05	0
71.	0.43	1PHG	Zf=0	3	3	0.05	-0.3
72.	0.43	1PHG	Zf=0	3	3	0.05	0.3
73.	0.43	1PHG	Zf=Zs	10 [and POC SCR]	14 [and POC X/R]	1	0
74.	0.43	1PHG	Zf=Zs	10	14	1	-0.3
75.	0.43	1PHG	Zf=Zs	10	14	1	0.3
76.	0.43	1PHG	Zf=Zs	3	14	1	0
77.	0.43	1PHG	Zf=Zs	3	3	1	-0.3
78.	0.43	1PHG	Zf=Zs	3	3	1	0.3
79.	0.43	1PHG	Zf=Zs	10 [and POC SCR]	14 [and POC X/R]	0.05	0
80.	0.43	1PHG	Zf=Zs	10	14	0.05	-0.3
81.	0.43	1PHG	Zf=Zs	10	14	0.05	0.3
82.	0.43	1PHG	Zf=Zs	3	14	0.05	0
83.	0.43	1PHG	Zf=Zs	3	3	0.05	-0.3
84.	0.43	1PHG	Zf=Zs	3	3	0.05	0.3
85.	2	L-L	Zf=0	10 [and POC SCR]	14 [and POC X/R]	1	0
86.	2	L-L	Zf=0	10	14	1	-0.3
87.	2	L-L	Zf=0	10	14	1	0.3
88.	2	L-L	Zf=0	3	14	1	0
89.	2	L-L	Zf=0	3	3	1	-0.3
90.	2	L-L	Zf=0	3	3	1	0.3
91.	2	L-L	Zf=0	10 [and POC SCR]	14 [and POC X/R]	0.05	0
92.	2	L-L	Zf=0	10	14	0.05	-0.3

Test	Fault duration [s]	Fault type	Fault impedance Zf [pu]	SCR	X/R	Active Power [pu]	Reactive Power [pu]
93.	2	L-L	Zf=0	10	14	0.05	0.3
94.	2	L-L	Zf=0	3	14	0.05	0
95.	2	L-L	Zf=0	3	3	0.05	-0.3
96.	2	L-L	Zf=0	3	3	0.05	0.3
97.	0.43	2PHG	Zf=Rf = 1, 5 and 10 Ohm	10 [and POC SCR]	14 [and POC X/R]	1	0
98.	0.43	2PHG	Zf=Rf = 1, 5 and 10 Ohm	10	14	1	-0.3
99.	0.43	2PHG	Zf=Rf = 1, 5 and 10 Ohm	10	14	1	0.3
100.	0.43	2PHG	Zf=Rf = 1, 5 and 10 Ohm	3	14	1	0
101.	0.43	2PHG	Zf=Rf = 1, 5 and 10 Ohm	3	3	1	-0.3
102.	0.43	2PHG	Zf=Rf = 1, 5 and 10 Ohm	3	3	1	0.3
103.	0.43	2PHG	Zf=Rf = 1, 5 and 10 Ohm	10 [and POC SCR]	14 [and POC X/R]	0.05	0
104.	0.43	2PHG	Zf=Rf = 1, 5 and 10 Ohm	10	14	0.05	-0.3
105.	0.43	2PHG	Zf=Rf = 1, 5 and 10 Ohm	10	14	0.05	0.3
106.	0.43	2PHG	Zf=Rf = 1, 5 and 10 Ohm	3	14	0.05	0
107.	0.43	2PHG	Zf=Rf = 1, 5 and 10 Ohm	3	3	0.05	-0.3
108.	0.43	2PHG	Zf=Rf = 1, 5 and 10 Ohm	3	3	0.05	0.3
109.	0.43	1PHG	Zf=Rf = 1, 5 and 10 Ohm	10 [and POC SCR]	14 [and POC X/R]	1	0
110.	0.43	1PHG	Zf=Rf = 1, 5 and 10 Ohm	10	14	1	-0.3
111.	0.43	1PHG	Zf=Rf = 1, 5 and 10 Ohm	10	14	1	0.3
112.	0.43	1PHG	Zf=Rf = 1, 5 and 10 Ohm	3	14	1	0
113.	0.43	1PHG	Zf=Rf = 1, 5 and 10 Ohm	3	3	1	-0.3

Test	Fault duration [s]	Fault type	Fault impedance Zf [pu]	SCR	X/R	Active Power [pu]	Reactive Power [pu]
114.	0.43	1PHG	Zf=Rf = 1, 5 and 10 Ohm	3	3	1	0.3
115.	0.43	1PHG	Zf=Rf = 1, 5 and 10 Ohm	10 [and POC SCR]	14 [and POC X/R]	0.05	0
116.	0.43	1PHG	Zf=Rf = 1, 5 and 10 Ohm	10	14	0.05	-0.3
117.	0.43	1PHG	Zf=Rf = 1, 5 and 10 Ohm	10	14	0.05	0.3
118.	0.43	1PHG	Zf=Rf = 1, 5 and 10 Ohm	3	14	0.05	0
119.	0.43	1PHG	Zf=Rf = 1, 5 and 10 Ohm	3	3	0.05	-0.3
120.	0.43	1PHG	Zf=Rf = 1, 5 and 10 Ohm	3	3	0.05	0.3

3.2.6. Multiple Fault Ride Through (MFRT) test [PSCAD™/EMTDC™ models]

Five test sequences will be tested on the basis of randomly generated events for the minimum SCR and corresponding X/R applicable at POC²⁴. Models are not required to ride through all tests. The purpose is to test robustness and suitability including MFRT protective settings for the model itself.

Table 5 MFRT random event selection for EMTD model test

Sequence	RANDOM (Fault Type)	RANDOM (Fault Duration [ms])	RANDOM (Time between recurring events [s])	RANDOM (Fault Impedance)
S2 to S5	6 x 1PHG, 7 x 2PHG, 2 x 3PHG	8 x 120ms, 6 x 220ms, 1 x 430ms	0.01, 0.01, 0.2, 0.2, 0.5, 0.5, 0.75, 1, 1.5, 2, 2, 3, 5, 7, 10	7 x Zf = 0 5 x Zf = 3 x Zs 3 x Zf = 2 x Zs

Test	Fault duration [s]	Fault type	Fault impedance Zf [pu]	SCR	X/R	Active Power [pu]	Reactive Power [pu]
121.	Sequence S1*	See note A	Zf=0.25 x Zs	POC	POC	1	0
122.	Sequence S2	S2	S2	POC	POC	1	0
123.	Sequence S3	S3	S3	POC	POC	1	0
124.	Sequence S4	S4	S4	POC	POC	1	0

²⁴ The purpose of the test is to assess MFRT capability where models are adequately equipped with protective functions.

Test	Fault duration [s]	Fault type	Fault impedance Zf [pu]	SCR	X/R	Active Power [pu]	Reactive Power [pu]
125.	Sequence S5	S5	S5	POC	POC	1	0

Note A. Sequence S1 includes application of a 3PHG fault at 5, 5.25, 5.5 seconds, followed by 2PHG fault at 8, 11 and 13 seconds. Each fault is of 100ms duration. Sequence (S1) is a specific sequence whilst others (S2 to S4) are randomly generated.

3.2.7. MFRT Test [PSS®E models]

Five test sequences will be tested on the basis of randomly generated balanced fault events for the minimum SCR and X/R applicable at POC.

Note: As events are of balanced type, this test may also include overlays against EMTP balanced case application.

Table 6 MFRT random event selection for RMS model test

Sequence	RANDOM (Fault Type)	RANDOM (Fault Duration [ms])	RANDOM (Time between recurring events [s])	RANDOM (Fault Impedance)
P1 to P5	15 x 3PHG	8 x 120ms, 6 x 220ms, 1 x 430ms	0.01, 0.01, 0.2, 0.2, 0.5, 0.5, 0.75, 1, 1.5, 2, 2, 3, 5, 7, 10	2 x Zf = 0, 3 x Zf = 0.2xZs 5 x Zf = 1xZs 3 x Zf = 2 x Zs 2 x Zf = 3.5 x Zs

Test	Fault Duration [s]	Fault Type	Fault Impedance Zf [pu]	SCR	X/R	Active Power [pu]	Reactive Power [pu]
126.	Sequence P1	P1	P1	POC	POC	1	0
127.	Sequence P2	P2	P2	POC	POC	1	0
128.	Sequence P3	P3	P3	POC	POC	1	0
129.	Sequence P4	P4	P4	POC	POC	1	0
130.	Sequence P5	P5	P5	POC	POC	1	0

3.2.8. Additional tests for MFRT

Unless protection trips are captured by MFRT tests, at least two additional tests shall be carried out to explicitly confirm protection pick up and the trip.

3.2.9. Temporary Over-Voltage (TOV) Test [PSS®E and PSCAD™/EMTDC™ models]

Note: The test case is carried out via application of a switched shunt (capacitive) element at POC. The table below assumes lowest SCR value of 3. If the SCR values are expected to be

lower than 3 at the generating system’s or integrated resource system’s connection point, then the expected SCR values for system normal and the most severe credible contingency should be used.

Table 7 TOV test case

Test	Fault duration [s]	Fault type	Fault impedance Zf [pu]	SCR	X/R	Active Power [pu]	Reactive Power [pu]
131.	0.9		Yf = jXc (U_Ov = 1.15pu)	10	14	1	0
132.	0.9		Yf = jXc (U_Ov = 1.15pu)	10	14	1	-0.3
133.	0.9		Yf = jXc (U_Ov = 1.15pu)	10	14	1	0.3
134.	0.9		Yf = jXc (U_Ov = 1.15pu)	3	14	1	0
135.	0.9		Yf = jXc (U_Ov = 1.15pu)	3	3	1	-0.3
136.	0.9		Yf = jXc (U_Ov = 1.15pu)	3	3	1	0.3
137.	0.9		Yf = jXc (U_Ov = 1.15pu)	POC	POC	1	0
138.	0.9		Yf = jXc (U_Ov = 1.15pu)	POC	POC	1	-0.3
139.	0.9		Yf = jXc (U_Ov = 1.15pu)	POC	POC	1	0.3
140.	0.1		Yf = jXc (U_Ov = 1.2pu)	10	14	1	0
141.	0.1		Yf = jXc (U_Ov = 1.2pu)	10	14	1	-0.3
142.	0.1		Yf = jXc (U_Ov = 1.2pu)	10	14	1	0.3
143.	0.1		Yf = jXc (U_Ov = 1.2pu)	3	14	1	0
144.	0.1		Yf = jXc (U_Ov = 1.2pu)	3	3	1	-0.3
145.	0.1		Yf = jXc (U_Ov = 1.2pu)	3	3	1	0.3
146.	0.1		Yf = jXc (U_Ov = 1.2pu)	POC	POC	1	0
147.	0.1		Yf = jXc (U_Ov = 1.2pu)	POC	POC	1	-0.3
148.	0.1		Yf = jXc (U_Ov = 1.2pu)	POC	POC	1	0.3

3.2.10. Voltage reference step change [PSS®E and PSCAD™/EMTDC™ models]

Note: Voltage Reference is applied as a *relative change* (whereas the figure indicates an absolute change from 1.0 pu) from the starting voltage reference of the plant or generating unit/production unit controller, taking into account system strength, reactive power flow and the droop functionality. The droop value (%) is assumed to be smaller than the 5% applied voltage reference change, otherwise higher reference change is to be applied. Reactive reference change test is performed with the PF and/or reactive power controller.

* The table below assumes lowest SCR value of 3. If the SCR values are expected to be lower than 3 at the generating system’s or integrated resource system’s connection point, then the expected SCR values for system normal and the most severe credible contingency should be used.

Table 8 Voltage and Reactive Power (and/or PF) control reference step change test

Test	Event	SCR	X/R	Active Power [pu]	Reactive Power [pu]
149.	Relative voltage reference change as per Fig 3	10	14 and 3	1	0
150.	Relative Voltage reference change as per Fig 3	10	14 and 3	0.05	0
151.	Relative voltage reference change as per Fig 3	3*	14 and 3	1	0
152.	Relative voltage reference change as per Fig 3	3*	14 and 3	0.05	0
153.	Relative voltage reference change as per Fig 3	POC	POC	1	0
154.	Relative voltage reference change as per Fig3	POC	POC	0.05	0
155.	Relative Voltage step change as per Fig 4	10	14 and 3	1	0
156.	Relative Voltage step change as per Fig 4	10	14 and 3	0.05	0
157.	Relative Voltage step change as per Fig 4	3*	14 and 3	1	0
158.	Relative Voltage step change as per Fig 4	3*	14 and 3	0.05	0
159.	Relative Voltage step change as per Fig 4	POC	POC	1	0
160.	Relative Voltage step change as per Fig 4	POC	POC	0.05	0
161.	Reactive Power and PF reference change as per Fig 5	10	14 and 3	1	0
162.	Reactive Power and PF reference change as per Fig 5	10	14 and 3	0.05	0
163.	Reactive Power and PF reference change as per Fig 5	3*	14 and 3	1	0
164.	Reactive Power and PF reference change as per Fig 5	3*	14 and 3	0.05	0
165.	Reactive Power and PF reference change as per Fig 5	POC	POC	1	0

Test	Event	SCR	X/R	Active Power [pu]	Reactive Power [pu]
166.	Reactive Power and PF reference change as per Fig 5	POC	POC	0.05	0

Figure 3 5% Voltage reference step test [pu]

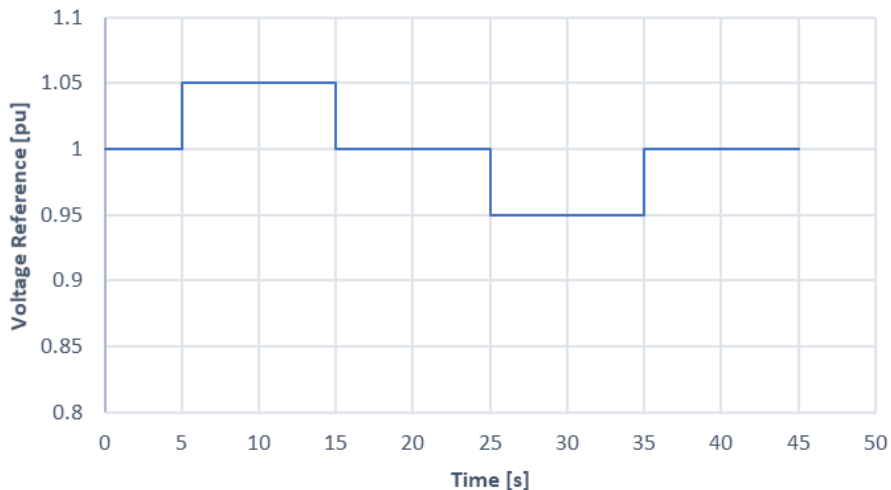

Figure 4 5% Grid voltage step response test [pu]

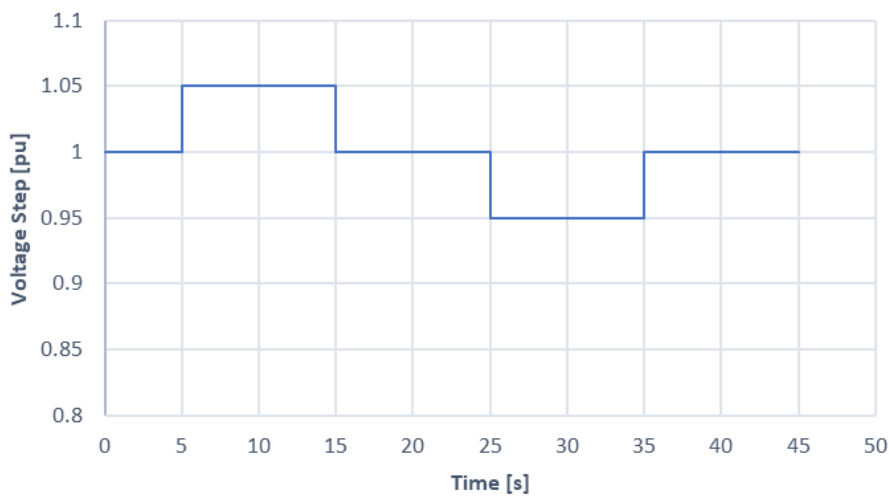
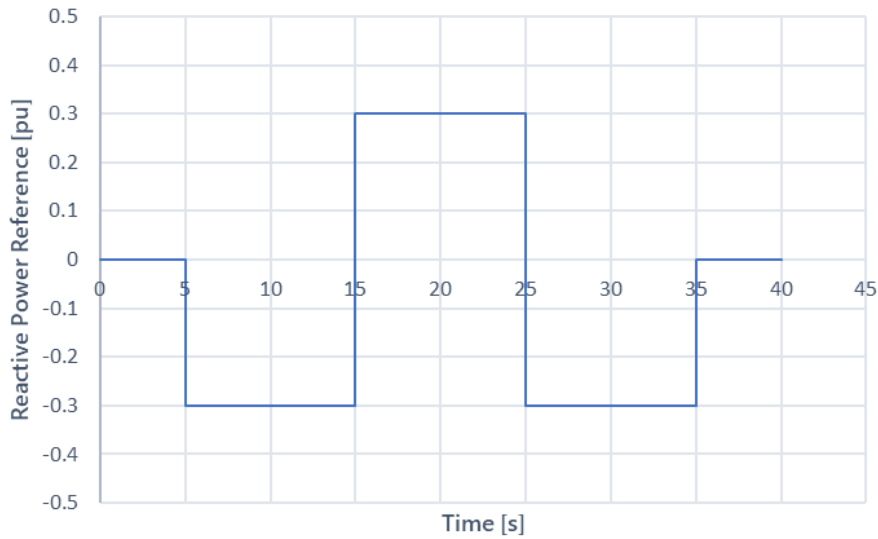

Figure 5 Reactive Power (and/or PF) reference test [pu]



Note: For PF tests, appropriate PF control setpoint is to be issued to achieve (at least) targeted 0.3 pu change in the reactive power output.

3.2.11. Active Power Controller Reference step change [PSS@E and PSCAD™/EMTDC™ models]

Note: Active Power Reference is applied as a relative change from the starting power reference of the plant or **generating unit/production unit** controller, taking into account system strength and the droop functionality. The timing is expected to be of sufficient duration to allow reduction to occur. AEMO needs to be aware of cases where this is not possible, including evidence.

If the runback command is triggered through a binary signal rather than a reference change, this signal can be substituted for the Active Power Reference figure and details of the control are to be provided to AEMO.

* The table below assumes lowest SCR value of 3. If the SCR values are expected to be lower than 3 at the generating system’s or integrated resource system’s connection point, then the expected SCR values for system normal and the most severe credible contingency should be used.

Table 9 Active Power Controller Reference step change test

Test	Event	SCR	X/R	Active Power [pu]	Reactive Power [pu]
167.	Active Power controller reference change as per Fig 6	10	14	1	0
168.	Active Power controller reference change as per Fig 6	3*	14	1	0
169.	Active Power controller reference change as per Fig 6	POC	POC	1	0

Figure 6 Active Power Reference [pu]

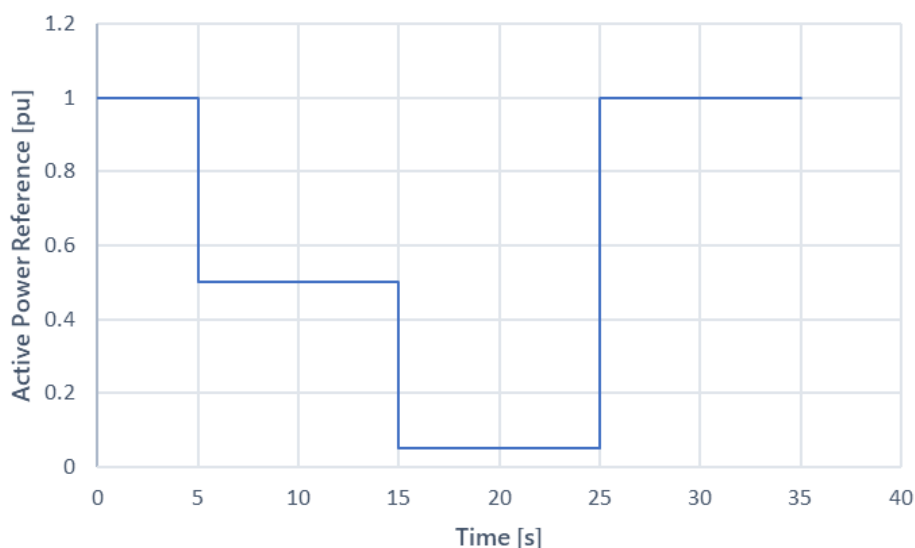

Acceptance criteria is based on the plant reaching the reference point before the next step is applied. In cases where this is not possible, evidence must be provided to substantiate the shortfalls. This requirement must be met by IBR.

3.2.12. Grid frequency – controller test [PSS®E and PSCAD™/EMTDC™ models]

Note: The plant must have its protective frequency or frequency control functions modelled.

For overfrequency, the frequency controller deadband²⁵ may be set to a range between +15 millihertz (mHz) and +1 Hz. For underfrequency, Plant controller deadband is set to -15 mHz.

Table 10 Grid frequency controller test

Test	Event	SCR	X/R	Available Power [%]	Active Power [pu]	Reactive Power [pu]
170.	Grid Frequency change as per Fig 7	POC	POC	100%	1	0
171.	Grid Frequency change as per Fig 7	POC	POC	100%	0.5	0
172.	Grid Frequency change as per Fig 7	POC	POC	50%	0.5	0
173.	Grid Frequency change as per Fig 7	POC	POC	5%	0.05	0
174.	Grid Frequency change as per Fig 8	POC	POC	100%	1	0
175.	Grid Frequency change as per Fig 8	POC	POC	100%	0.5	0

²⁵ Or use 0, if no deadband is applicable/used, for example, for reciprocating machine.

Test	Event	SCR	X/R	Available Power [%]	Active Power [pu]	Reactive Power [pu]
176.	Grid Frequency change as per Fig 8	POC	POC	50%	0.5	0
177.	Grid Frequency change as per Fig 8	POC	POC	5%	0.05	0

Figure 7 Grid frequency test – overfrequency [Hz] (fast 4 Hz/sec (250 ms) ramp rate and frequency reaching 52 Hz over 3 seconds)

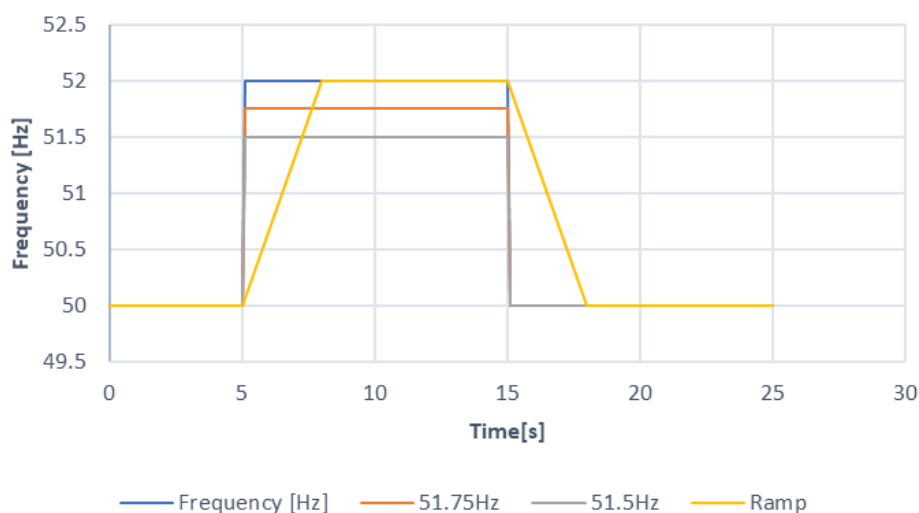
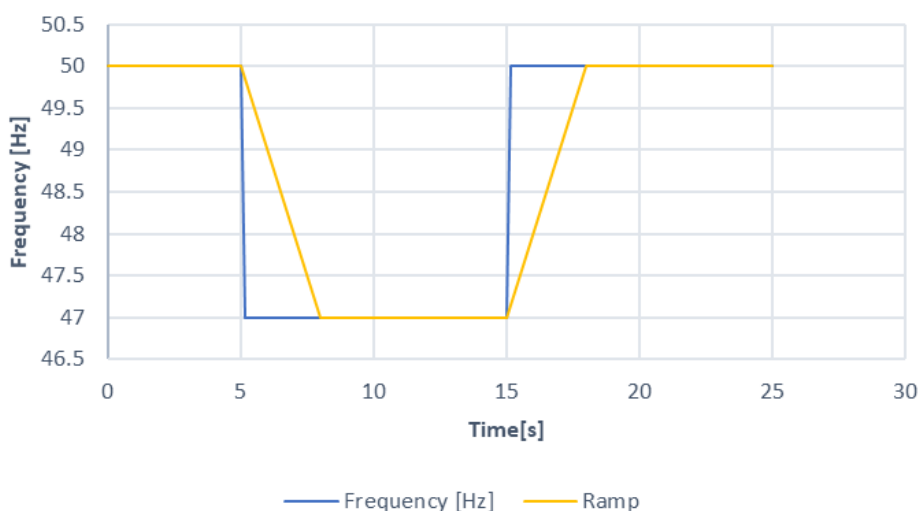

Figure 8 Grid frequency test – underfrequency (fast 4 Hz/sec (250 ms) ramp rate and frequency change of 1 Hz/second over 3 seconds)



3.2.13. Inertia – frequency control Model Acceptance Test

Plants/models with inertia controllers would be tested on case-by-case basis, taking into consideration, for example:

- Stored energy.

- Inertia period/ underfrequency.
- The speed of the response.
- Activation deadband.
- Plant settings (for example, droop).
- Recovery characteristics.

3.2.14. Grid voltage change – response test [PSS®E and PSCAD™/EMTDC™ models]

Note: The magnitude of grid voltage change may be adjusted by AEMO to take into account losses across the equivalent system impedance.

The model is required to maintain its active power output for ramp signals in Figure 9 without reliance on tap changers.

The model may be expected to engage its FRT function (LVRT/HVRT) for step signals in Figure 10 and the activation and deactivation flags shall be observed. No tap changer action is considered.

* The table below assumes lowest SCR value of 3. If the SCR values are expected to be lower than 3 at the generating system's or integrated resource system's connection point, then the expected SCR values for system normal and the most severe credible contingency should be used.

Table 11 Grid voltage response test

Test	Event	SCR	X/R	Active Power [pu]	Reactive Power [pu]
178.	Grid Voltage is ramped/modulated as per Fig 9	10	14 and 3	1	0
179.	Grid Voltage is ramped/modulated as per Fig 9	3*	14 and 3	1	0
180.	Grid Voltage is ramped/modulated as per Fig 9	POC	POC	1	0
181.	Grid Voltage is ramped/modulated as per Fig 9	POC	POC	0.5	0
182.	Grid Voltage step as per Fig 10	10	14 and 3	1	0
183.	Grid Voltage step as per Fig 10	3*	14 and 3	1	0
184.	Grid Voltage step as per Fig 10	POC	POC	1	0
185.	Grid Voltage step as per Fig 10	POC	POC	0.5	0
186.	Grid Voltage is changed as per Fig 11	10	14 and 3	1	0
187.	Grid Voltage is changed as per Fig 11	3*	14 and 3	1	0
188.	Grid Voltage is changed as per Fig 11	POC	POC	1	0
189.	Grid Voltage is changed as per Fig 11	POC	POC	0.5	0

Figure 9 Grid voltage ramp response test [pu] (voltage ramped over 6 seconds)

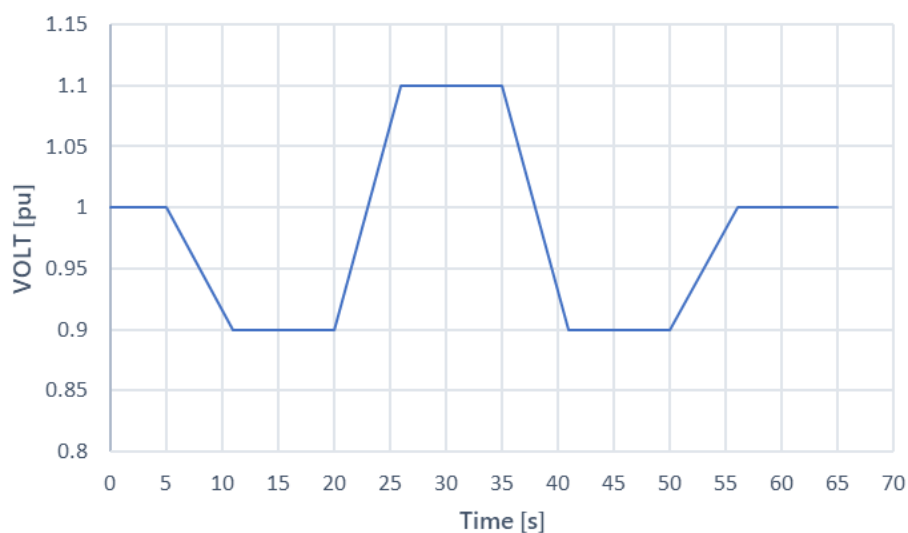

Figure 10 10% Grid voltage step response test [pu]

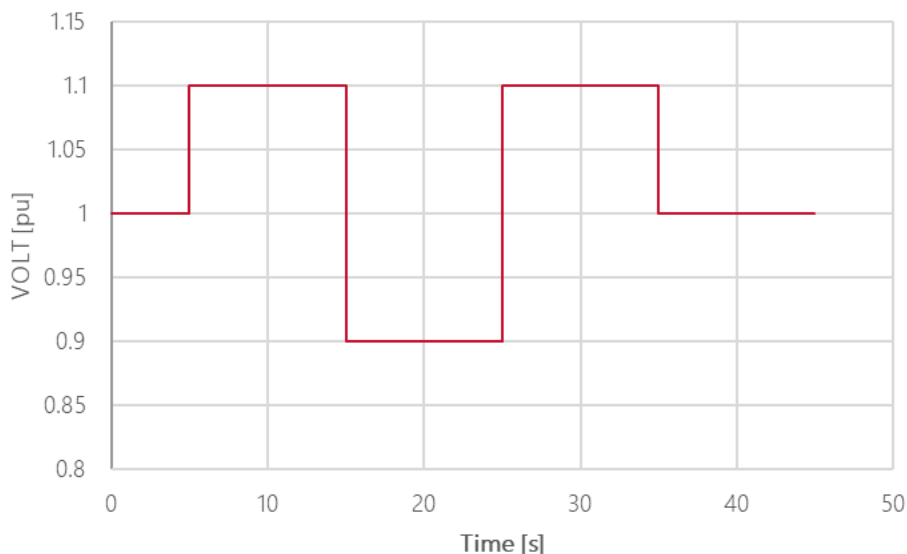
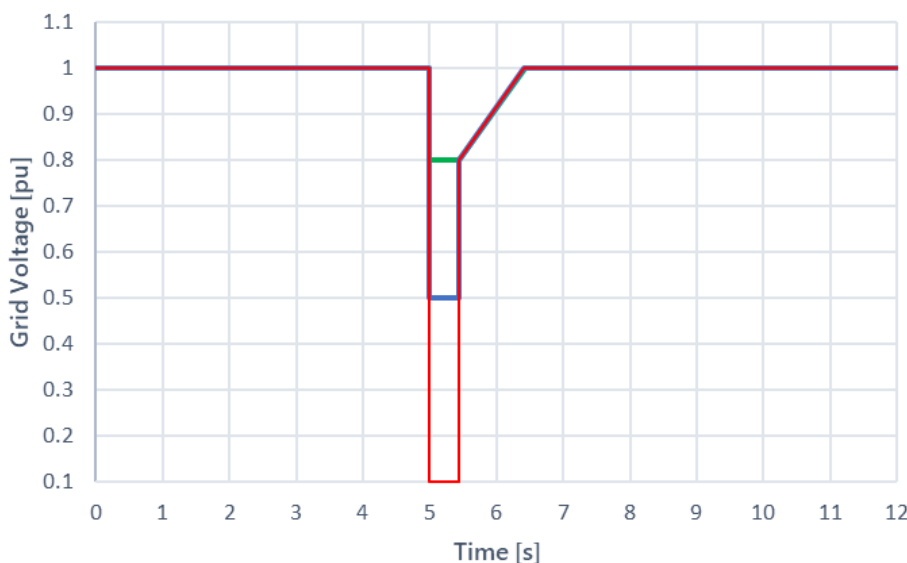

Figure 11 Extended dip grid voltage recovery test



Note: RED: 0.1 pu, BLUE: 0.5pu and GREEN: 0.8 pu voltage dip followed by 1 second ramped up recovery.

3.2.15. Grid Oscillation rejection test [PSCAD™/EMTDC™ models]

This is a control and response sensitivity test. It is expected that plant models maintain stable operation for all voltage modulated frequencies and for measured responses to be consistent with changes in current injection references. The test is primarily focused on IBR by monitoring active and reactive current references together with the resulting active and reactive current responses, however, the test is applied to all plant models.

Table 12 Grid oscillatory rejection test²⁶

Test	Event	SCR	X/R	Active Power [pu]	Reactive Power [pu]
190.	Grid Voltage is modulated, commencing at modulation frequency of 0.1Hz to 0.9Hz in steps of 0.1Hz per each simulation run. Tests are performed in a similar fashion as per Figure 12 with the exception of frequency steps being 0.1Hz.	POC	POC	1	0
191.	Grid Voltage is modulated, commencing at modulation frequency of 1Hz to 45Hz in steps of 1Hz per each simulation run. Figure 12 provides an example of the modulation signal at 1 and 10Hz.	POC	POC	1	0
192. ²⁷	In addition to amplitude modulation, at least 2 degree phase oscillation shifts as a minimum (sinusoidal signal injection) shall be added to the modulating frequency amplitude.	POC	POC	1	0

Figure 12 Oscillatory rejection tests [example of 1 Hz to 10 Hz in steps of 1 Hz per modulation]

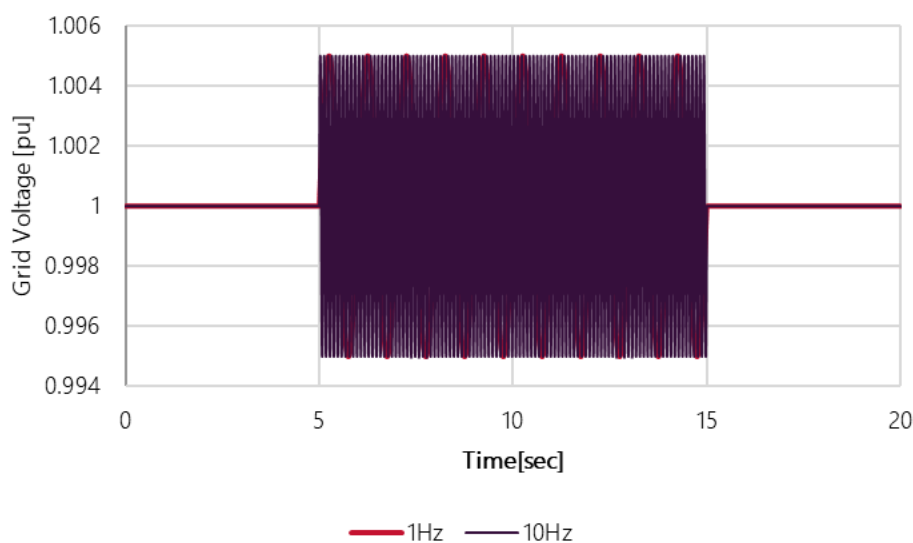

3.2.16. Grid voltage phase angle change – response test [PSS®E and PSCAD™/EMTDC™ models]

The applied phase angle changes are permanent step changes. The model is not expected to lose control or exacerbate the applied disturbance. Careful consideration, parameter tuning or redesign, including additional balance of plant equipment, may need to occur when conducting connection assessment studies for which transmission or distribution phase angle changes do occur, for example, typically on the application or clearance of applied contingencies in the

²⁶ The upper frequency at which tests would be conducted will depend on the control system bandwidth and may need to cover up to and including nominal frequency. At least tests up to 20Hz shall be performed as a minimum in all circumstances.

²⁷ Optional test where deemed necessary.

wide area power system model. In addition, such design will typically consider the appropriate X/R ratio and the instance of the contingency inception which may create additional complexities to remedy, for example, high DC offsets which could impact on the appropriate control of IBR. At least 2 points on the instantaneous waveform shall be evaluated (Table 13), including the maximum and zero crossing points. In addition, manufacturers are expected to provide evidence of the biggest phase angle change that their equipment can withstand²⁸.

* The table below assumes lowest SCR value of 3. If the SCR values are expected to be lower than 3 at the generating system’s or integrated resource system’s connection point, then the expected SCR values for system normal and the most severe credible contingency should be used.

Table 13 Grid phase angle response test²⁹

Test	Event	SCR	X/R	Active Power [pu]	Reactive Power [pu]
193.	Grid voltage angle change equal to $\pm 40^\circ$ and $\pm 60^\circ$	10	14 and 3	1	0
194.	Grid voltage angle change equal to $\pm 40^\circ$ and $\pm 60^\circ$	10	14 and 3	0.05	0
195.	Grid voltage angle change equal to $\pm 40^\circ$ and $\pm 60^\circ$	3*	14 and 3	1	0
196.	Grid voltage angle change equal to $\pm 40^\circ$ and $\pm 60^\circ$	3*	14 and 3	0.05	0
197.	Grid voltage angle change equal to $\pm 40^\circ$ and $\pm 60^\circ$	POC	POC	1	0
198.	Grid voltage angle change equal to $\pm 40^\circ$ and $\pm 60^\circ$	POC	POC	0.05	0

3.2.17. POC SCR = 1 Active Power reference change test [PSS®E and PSCAD™/EMTDC™ models]

This test increases active power reference in gradual steps until the plant reaches its rated output under low SCR conditions. Due to the low grid SCR, it is expected that the plant is unable to maintain stable operation at 100% output level. Active power ramp durations may be extended to meet the equipment maximum slew rate limitation.

²⁸ It is expected that IBR do not lose control for grid voltage angle change equal to $\pm 40^\circ$. These tests do not supersede network connection and compliance requirements where phase angle changes of different magnitude and duration may be present.

²⁹ Tests 193 to 198 include subsets of tests for $\pm 40^\circ$ and $\pm 60^\circ$ phase angle changes, where each test covers $+40^\circ$, -40° , $+60^\circ$ and -60° phase angle responses. They could be done in a sequence (with sufficient time between step applications to allow settled responses) or treated as standalone steps.

Table 14 SCR = 1: Active power reference change test

Test	Event	SCR	X/R	Active Power [pu]	Reactive Power [pu]
199.	Active Power controller reference change as per Fig 13	1	14 and 3	Starting from PSCAD™ initialisation	0

Figure 13 SCR = 1 Active power reference change test [pu]

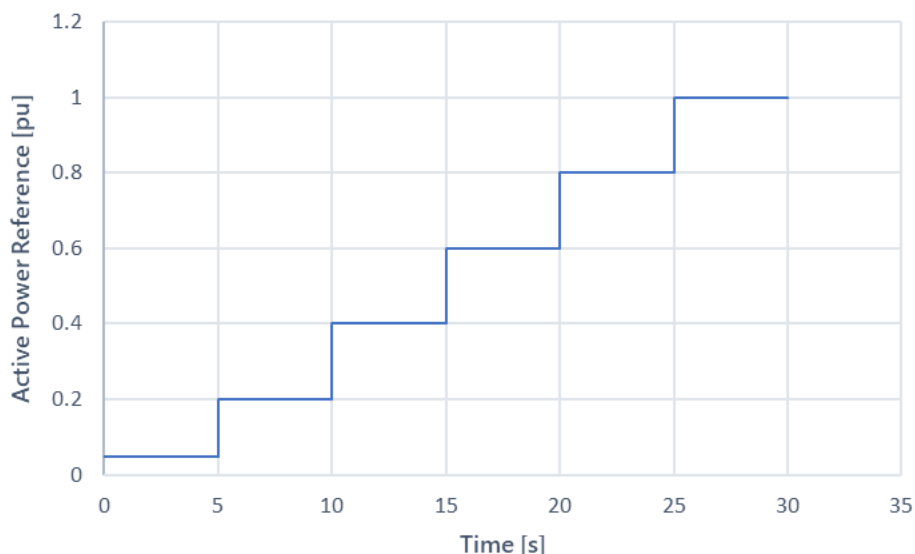

3.2.18. POC SCR = 1 FRT Test [PSS®E and PSCAD™/EMTDC™ models]

This test assesses the impact of system strength on fault ride through performance where pre-disturbance SCR conditions are lowered to SCR = 1. It is expected that the plant/model performance would not be able to sustain operation at SCR = 1. In cases where this is possible, evidence (other than modelled results) would be required to substantiate model ride through capability at SCR=1. (d=1 in all cases).

Table 15 SCR=1- FRT Test

Test	Fault duration [s]	Fault type	Fault impedance Zf [pu]	SCR [pre-fault]	SCR [post-fault]	X/R	Active Power [pu]	Reactive Power [pu]
200.	0.43	3PHG	Zf=4xZs (Udip ~ 0.8pu)	3	1	14 and 3	1.0	0
201.	0.43	3PHG	Zf=4xZs (Udip ~ 0.8pu)	3	1	14 and 3	0.5	0
202.	0.43	3PHG	Zf=4xZs (Udip ~ 0.8pu)	3	1	14 and 3	0.05	0
203.	0.43	3PHG	Zf=0	3	1	14 and 3	1.0	0
204.	0.43	3PHG	Zf=0	3	1	14 and 3	0.5	0
205.	0.43	3PHG	Zf=0	3	1	14 and 3	0.05	0

3.2.19. FRT assessment for site-specific SCR and X/R [PSS®E and PSCAD™/EMTDC™ models]

Note: SCR values for system normal and the most severe credible contingency should be used. (d=1 in all cases).

Table 16 FRT Benchmarking for POC SCR and X/R Conditions

Test	Fault duration [s]	Fault type	Fault impedance Z _f [pu]	Applied Fault Voltage [pu]	SCR [post-fault]	X/R	Active Power [pu]	Reactive Power [pu]
206.	0.43	3PHG	Z _f =0	0	POC	POC	1	0
207.	0.43	3PHG	Z _f =0.11 x Z _s	~0.1	POC	POC	1	0
208.	0.43	3PHG	Z _f =0.25 x Z _s	~0.2	POC	POC	1	0
209.	0.43	3PHG	Z _f =0.42 x Z _s	~0.3	POC	POC	1	0
210.	0.43	3PHG	Z _f =0.66 x Z _s	~0.4	POC	POC	1	0
211.	0.43	3PHG	Z _f =Z _s	~0.5	POC	POC	1	0
212.	0.43	3PHG	Z _f =1.5 x Z _s	~0.6	POC	POC	1	0
213.	0.43	3PHG	Z _f =2.3 x Z _s	~0.7	POC	POC	1	0
214.	0.43	3PHG	Z _f =4 x Z _s	~0.8	POC	POC	1	0
215.	0.43	3PHG	Z _f =9 x Z _s	~0.9	POC	POC	1	0
216.	0.43	3PHG	Z _f =0	0	POC	POC	0.5	0
217.	0.43	3PHG	Z _f =0.11 x Z _s	~0.1	POC	POC	0.5	0
218.	0.43	3PHG	Z _f =0.25 x Z _s	~0.2	POC	POC	0.5	0
219.	0.43	3PHG	Z _f =0.42 x Z _s	~0.3	POC	POC	0.5	0
220.	0.43	3PHG	Z _f =0.66 x Z _s	~0.4	POC	POC	0.5	0
221.	0.43	3PHG	Z _f =Z _s	~0.5	POC	POC	0.5	0
222.	0.43	3PHG	Z _f =1.5 x Z _s	~0.6	POC	POC	0.5	0
223.	0.43	3PHG	Z _f =2.3 x Z _s	~0.7	POC	POC	0.5	0
224.	0.43	3PHG	Z _f =4 x Z _s	~0.8	POC	POC	0.5	0
225.	0.43	3PHG	Z _f =9 x Z _s	~0.9	POC	POC	0.5	0

In addition, FRT Benchmarking may be done, if required or recommended, with:

- Reactive power values of QMAX (or near QMAX and agreed with AEMO) and QMIN (or near QMIN and agreed with AEMO). In absence of specific levels, +0.3pu and -0.3pu could be used as a minimum where positive values refer to export of reactive power and negative values refer to import of reactive power at the point of connection (e.g. operation in under excited region)

Note: QMAX and QMIN in this Guideline refer to the maximum and minimum reactive power limits before activation of limiters (if any). For IBR, this may also imply the steady state corner points of the relevant active-reactive power capability chart.

3.2.20. Input power source step change test

Modelled responses are expected to conform to the input power step change test as well as to validly reach the steady state value taking into consideration equipment mechanical or electrical controls- actuators, limiters etc. As an example, for wind turbines, that would relate to the pitch angle, power - speed controller and so on.

Table 17 Input power source step change (for example, wind speed, irradiance)

Test	Event	SCR	X/R	Active Power [pu]	Reactive Power [pu]
226.	Input source step change by - 20% from full output	POC	POC	1	0
227.	Input source step change by + 20% from full output	POC	POC	1	0
228.	Input source step change by + 20% from reduced output levels	POC	POC	0.5	0
229.	Input source step change by - 20% from reduced output levels	POC	POC	0.5	0

3.3. ~~Additional case studies for IBR generation~~ IBR generation systems and integrated resource systems technologies with low and high voltage ride-through function

For IBR with LVRT and HVRT control (assuming the voltage threshold for activation of the LVRT or HVRT control is k%), apply voltage step responses of (k+1)%, and (k-1) to ensure correct operation of the control without any oscillatory behaviour.

For systems with bidirectional units such as battery systems, this shall be tested in both charging and discharging regions.

3.4. Additional grid voltage tests for IBR operating at reduced energy source inputs

Grid voltage step tests (Figure 3) shall be applied and evaluated for IBR with variable input source (for example, wind or solar (irradiance)) considering the following:

- Maximum issued active power setpoint with IBR at unity power factor, QMAX, QMIN operation at the connection point (in absence of a defined value, at least 0, -0.3pu and +0.3 pu reactive power is expected to be applied)
- Input source set to 20% of maximum generation (for example, by adjusting the wind speed or irradiance)

- For IBR technologies requiring input energy source, commencing at 10% generation (e.g. corresponding irradiance, wind speed) reduce input source availability below the cut-in point, hold for at least 10 seconds, and then increase the input source availability to at least 10% generation levels. This is to check model capability and functional implementation for the operational switchover impact between the *stand-by* and the *generation* mode (examples could include reactive instabilities in PV solar farms due to oscillatory compensation via DC links, transition to and from reactive power control mode at no wind or no irradiance conditions, LVRT engagement of wind farms upon cut-in operation and so on).

Tests outcomes are expected to monitor DC bus voltage, active and reactive power in ensuring no material reduction or that DC link collapse occurs.

3.5. Additional case studies to verify minimum declared SCR that the IBR generation systems or integrated resource systems can sustain

Tests shall be carried out to verify the minimum stated SCR that the equipment can sustain and also conditions for which the plant will trip and/or lose control.

Note: statements around equipment dependability on electrical balance of plant design or different parameters that may affect low SCR capability will not be accepted.

Actual settings in question for the generating system or integrated resource system as well as the SCR of the equipment itself (without additional electrical balance of plant [eBoP] design, such as synchronous condensers) must be stated. If the settings differ from the settings applied at the time of the type test, then type tested settings are to be verified and the vendor shall inform AEMO of what settings changes are being considered for the generating system or integrated resource system in question for model acceptance testing (and the connection assessment)

For the defined SCR Limit, a test at such a limit or below the limit shall be used for verification (for example, test at 5% or 10% lower than the stated limit). Tests are expected to include, as a minimum:

- Demonstration of capability to export maximum steady state power as well as demonstration of inability to do so when operating at lower SCR value.
- Demonstrate the nature and conditions which cause instability (i.e. how is the loss of control or instability manifesting itself, examples could include voltage collapse, loss of active or reactive current control, low or high frequency oscillations, sustained or growing oscillations etc)
- Capability to satisfactorily perform FRT, overvoltage, voltage reference, and grid voltage changes. as well as frequency disturbance responses, including demonstration of inability to do so when operating at lower SCR value. These tests shall include balanced and unbalanced faults as well as phase angle jumps.

3.6. Additional case studies for synchronous generators and synchronous condenser systems

In addition to P_{MAX}, the minimum level of active power for synchronous generator test application shall be set to P_{MIN}, if P_{MIN} is greater than the active power initial setpoint of 0.05 pu used throughout this Guideline.

Note: P_{MIN} in this Guideline refers to design minimum operating limit. For synchronous condensers, initial active power of zero shall be applied.

3.6.1. Excitation system limiters

To test any limiter, control, or protection (such as under- and over-excitation limiters) in synchronous machines, adjust the operating conditions such that these controls can be activated. The following case studies are generally used to demonstrate correct operation of the limiters.

Case study 1

On-load V_{ref} step responses over the capability of the plant at three load levels: minimum load, full load, and one or more loading levels between the minimum and the maximum load:

- 5% step in V_{ref} starting from within the Under-excitation limiter (UEL) and not operating into another limiter.
- 5% step in V_{ref} starting from within the generator's capability curve. The final settling value should be just within the UEL and should not enter into any limiter, including the UEL.
- 5% step in V_{ref} starting from within the Over-excitation limiter (OEL) and not operating into another limiter.
- 5% step in V_{ref} starting from within the generator's capability curve. The final settling value should be just within the OEL and should not enter into any limiter, including the OEL.

Figure 14 Step response simulations without limiter operation

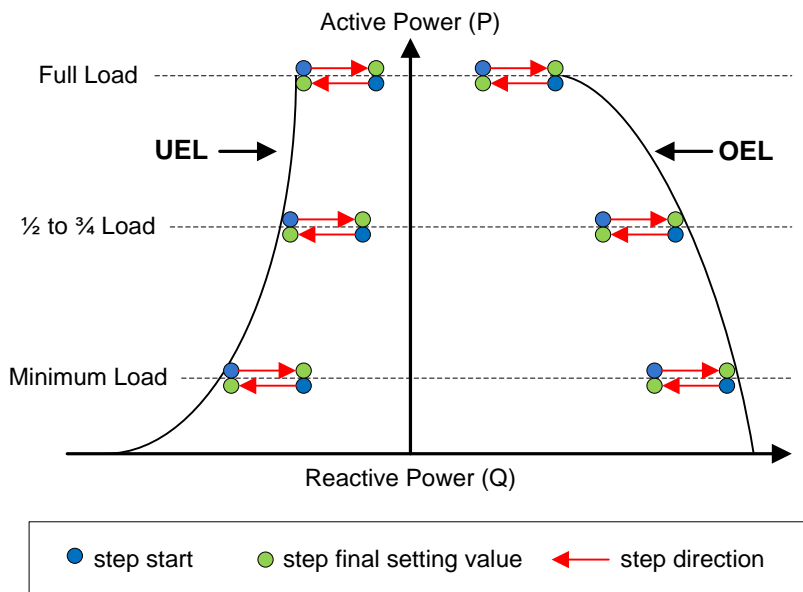

Case study 2

On load Vref step responses into excitation limiters over the capability of the plant at three load levels: minimum load, full load, and one or more loading levels in between. Step responses should be determined at each loading level for (see Figure 14):

- 5% step in Vref, into the UEL.
- 5% step in Vref, into the OEL.

Limiter tests shall clearly indicate the response that engages and disengages the limiter action.

Figure 15 Step response simulations into UEL and OEL

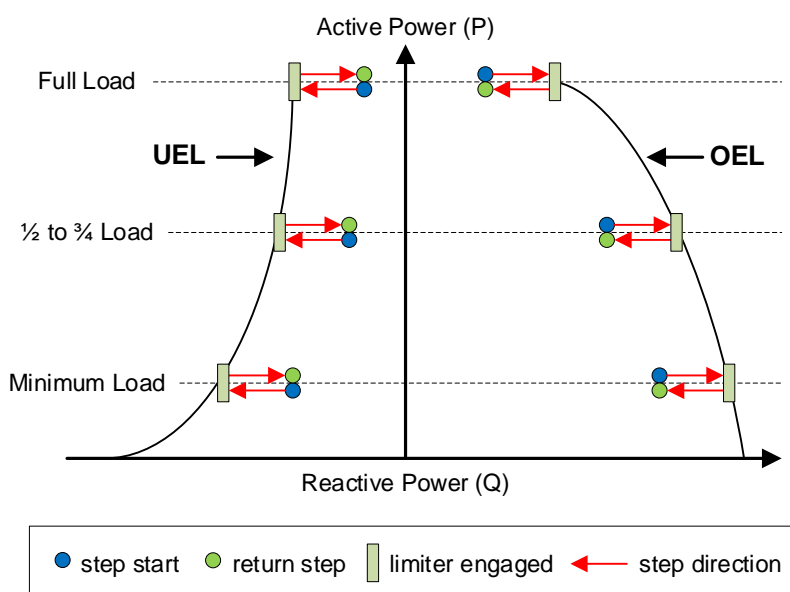

3.6.2. Governor

To ensure there is no adverse interaction between the governor and PSS, the following case study is carried out (for time domain studies, and not ruling out small signal assessment of the linearised model otherwise): for operation at full load and unity power factor compare PSS performance ~~with and with~~ and without the governor model (constant mechanical power applied to the synchronous generator model). The governor is not expected to materially change the overall performance.

3.7. Additional case studies for dynamic reactive support plant

Similar tests presented in this Guideline apply. The only difference is that the device does not transfer any active power in steady-state. The tests are therefore not repeated considering various active power levels.

When mode changes are involved within the operating range of the device – for example, changeover from thyristor switched capacitor (TSC) mode to thyristor controlled reactor (TCR) for SVCs – the model acceptance testing will be carried out in the vicinity of the changeover point to confirm correct operation when changeover occurs.

3.8. Additional tests for IBRs with reactive power mode without active power production

All tests in this guideline shall be undertaken with the exception that the active power output is zero.

3.9. Additional tests for ~~battery-equipped~~integrated resource systems

Similar tests apply, ~~with battery power levels~~ considering charging consumption (e.g. battery charging) and discharging production (e.g. battery discharging) operating regions, therefore additional tests are required for charging consumption region, with active power levels at -0.05 pu, -0.5 pu, and -1 pu.

3.10. Additional tests for South Australian Connections

For connections in South Australia, the following tests shall be undertaken and required to pass the MAT:

- Tests outlined in Tables 3 to 14, and Table 16, where the lower SCR ratio conditions are replaced with specific requirements for South Australia, at equipment terminals:
 - SCR of 1.5.
 - X/R = 2.

3.11. Other technologies

To accommodate other technologies or model types, additional or separate tests may be required and would be discussed and agreed with the vendor prior to progressing with the model testing.

3.12. Model integration into AEMO's OPDMS and PSCAD™ network case

The model would be assessed against the following, and not necessarily limited to:

- Compilation test – to ensure the model compiles into a single (NEM) DSUSR.dll in any FORTRAN (compiler, and, PSS®E and PSCAD™/EMTDC™) version required by AEMO.
- Full NEM study case – to ensure the model has no issue being integrated into a complete NEM snapshot³⁰, there are no model interactions, and it responds to flat and fault conditions without crashing and with an expected response.

³⁰ The model must be robust, initialise, run in a stable manner, and not crash for any operating conditions of the actual plant being snapped in OPDMS, e.g. this may apply to solar farm models or wind farm models, at no sun or no wind conditions, respectively.

- For PSS@E models³¹, the following 50 second initialisation tests shall be done to ensure no initialisation issues:
 - The model should be tested with 4 sets of tuned full NEM snapshots – these can be obtained from AEMO’s Data Request.
 - The model should be tested for each set of snapshots at 20% 40% 60% 80% and 100% of Real Power capacity including at 0, -0.3pu and 0.3pu of reactive power.
 - If there is more than one unit, one set of snapshots should be tested with at least one of the units switched out. The other unit/s should be at 20% and 80% of real power capacity.
 - ANGLE of PSS@E user models must be flat for the duration of the initialisation run in the SMIB and the full network case
- To assess there is no major reduction in the simulation speed for AEMO’s application environment.

³¹ If there is a governor model that requires a waterway model it is expected to be of MINS (miscellaneous) model type.

Appendix A. DMAT checklist

Table 18 Model source code, transfer function block diagrams, technical description, and complete parameter list

	Item	Comment	Checkbox	
1.	Encrypted (in addition to unencrypted) model in PSS@E (and DLL files compatible with AEMO’s PSS@E versions in use at time of application for assessment).	See Note A	Yes <input type="checkbox"/>	No <input type="checkbox"/>
2.	PSCAD™/EMTDC™ model compiled with Intel Visual FORTRAN Compiler, compatible with AEMO’s versions in use at time of application for assessment.		Yes <input type="checkbox"/>	No <input type="checkbox"/>
3.	The PSS@E model has the following information: <ul style="list-style-type: none"> • Generating-Production unit model. • Plant controller – Voltage Control. • Plant Controller – Reactive Power control. • Plant Controller – PF Control. • Plant Controller – Frequency Control. • Plant Controller – Active Power Control. • MFRT protective mechanisms are implemented. 	Models with all control features are required unless exempt. Models which have parts of the plant controller expected functions implemented within the Generating-Production unit, shall be stated. For example, this could relate to frequency or voltage Control of synchronous generating units.	Yes <input type="checkbox"/>	No <input type="checkbox"/>
4.	The PSCAD™/EMTDC™ model has the following information: <ul style="list-style-type: none"> • Generating-Production unit model. • Plant controller – Voltage Control. • Plant Controller – Reactive Power control. • Plant Controller – PF Control. • Plant Controller – Frequency Control. • Plant Controller – Active Power Control. • MFRT protective mechanisms are implemented. 	Models with all control features are required unless exempt. Models which have parts of the plant controller expected functions implemented within the Generating-Production unit, shall be stated. For example, this could relate to frequency or voltage Control of synchronous generating units.	Yes <input type="checkbox"/>	No <input type="checkbox"/>
			Yes <input type="checkbox"/>	No <input type="checkbox"/>
			Yes <input type="checkbox"/>	No <input type="checkbox"/>
			Yes <input type="checkbox"/>	No <input type="checkbox"/>
			Yes <input type="checkbox"/>	No <input type="checkbox"/>
			Yes <input type="checkbox"/>	No <input type="checkbox"/>
5.	Corresponding model source codes.	The model block diagram must represent the corresponding model source code, see Note B.	Yes <input type="checkbox"/>	No <input type="checkbox"/>
6.	Transfer Function Block Diagram indicating all STATES, and CONS.	For PSS@E – Generating Production Unit, see Note C.	Yes <input type="checkbox"/>	No <input type="checkbox"/>
7.	Transfer Function Block Diagram indicating all STATES, and CONS.	For PSS@E – Generating System/ Integrated Resource System Plant Controller, see Note C.	Yes <input type="checkbox"/>	No <input type="checkbox"/>
8.	For the PSCAD™ model, if the transfer function diagram and parameters are different from the implemented version in PSS@E, a PSCAD™ specific transfer function diagram shall be provided indicating the applicable settings and a mapping file provided to substantiate parameter alignment between the two software platforms and models. Examples of such could be and not necessarily limited to, for example, Simulink model or a detailed functional description document with all control block diagram masks and values provided.	For the Plant Controller, and for the Generating-Production Unit	Yes <input type="checkbox"/>	No <input type="checkbox"/>

	Item	Comment	Checkbox
9.	<p>For PSCAD™/EMTDC™ a complete list of all parameters consistent with NER 5.2.5, S5.2.4, Power System Design Data Sheets and Power System Setting Data Sheets, and, the <i>Power System Model Guidelines</i>.</p> <p>Examples include settings for LVRT Logic, HVRT, Look Up Tables or Gain – Current Charts (Active and Reactive Current Control Settings, including all setting and limits for control of balanced and unbalanced faults, PLL settings, freeze times/states/thresholds and settings).</p> <p>Plant Controller with all modes of operation [for example, inputs, filtering, limiters, resetter, transport delays, dispatched signal, gains and integrators].</p> <p>All applicable protection settings.</p>	<p>See Note D.</p> <p>For example, for PSCAD™/EMTDC™ parameter list files may include *.f or *.txt user configurable parameters that are LINK-ed during the PSCAD™/EMTDC™ runtime.</p>	Yes <input type="checkbox"/> No <input type="checkbox"/>

- A. Dynamic data must be provided as ‘per unit’ quantities on the machine MVA base.
- B. It is also expected that the functional block diagrams provided with the Power System Design and Setting Data Sheets for a specific generating system/[integrated resource system](#) connection will match these diagrams at time of Registration, although the parameter values might differ to reflect particular connection point performance requirements. All parameter values must be included and shown, for example, as an Appendix.
- C. The model inputs and outputs shown in the transfer function block diagram representation must match those indicated in the model datasheet tables. The state variables shown in the transfer function block diagram representation must match those indicated in the model datasheet tables. Model documentation and transfer function block diagram representation must be provided at the level of detail required for AEMO and the network service providers to derive the corresponding linear small-signal model of the equipment.
- D. Prior to undertaking MAT, AEMO may ask to sight the source code of the PSCAD™/EMTDC™ and a complete parameter file applicable. In general, AEMO acknowledges that certain technologies may have an exhaustive list of values, some which may not be of direct relevance for the intended purpose – in these cases a shortlist of relevant parameters could be agreed with AEMO.

Table 19 Evidence of type test (or otherwise, such as laboratory converter module test) FRT validation, evidence of low SCR capability, evidence of multiple FRT testing and validation including protective mechanisms

	Item	Comment	Checkbox
10.	<p>FRT Validation report comparing the model’s fault ride-through performance with the measurements and validation against:</p> <ul style="list-style-type: none"> • PSS®E model and measured results, and. • PSCAD™/EMTDC™ and measured results. • Balanced faults validation (type test report and model overlays). • Unbalanced fault validation (type test report and model overlay). 	<p>The accuracy of the model must be clearly referenced against the accuracy requirements specified in the AEMO <i>Power System Model Guidelines</i>.</p>	Yes <input type="checkbox"/> No <input type="checkbox"/>
11.	<p>Confirmation that the model is fit for multi- disturbance application and evidence provided:</p> <ul style="list-style-type: none"> • Type tests (or laboratory tests, HIL test). • Protective elements being included in the model for this purpose for both: PSS®E and the PSCAD™/EMTDC™ models. • Model validation for both. 	<p>Provision of Voltage and Frequency protection limits only are not regarded as adequate for this purpose.</p>	Yes <input type="checkbox"/> No <input type="checkbox"/>
12.	<p>Low SCR statement of capability and evidence provided which shows when the technology is unable to perform under low SCR conditions:</p> <ul style="list-style-type: none"> • Evidence must include either laboratory (module) simulated/tested or actual tested results. • Evidence must include overlays with PSS®E and PSCAD™/EMTDC™. 	<p>Statement that behaviour under low SCR may be subject to eBoP design or particular grid conditions that need to be evaluated, are not found acceptable. This also applies to statements quoting that non default settings could be</p>	Yes <input type="checkbox"/> No <input type="checkbox"/>

	Item	Comment	Checkbox
		<p>optimised for low SCR conditions.</p> <p>The accuracy of the model must be clearly mentioned against the accuracy requirements specified in the AEMO's <i>Power System Model Guidelines</i>.</p>	
13.	<p>Overvoltage ride-through validation report comparing the model's fault ride-through performance with the measurements and validation against:</p> <ul style="list-style-type: none"> • PSS®E model and measured results, and • PSCAD™/EMTDC™ and measured results. 	<p>The accuracy of the model must be clearly mentioned against the accuracy requirements specified in the AEMO <i>Power System Model Guidelines</i>.</p>	Yes <input type="checkbox"/> No <input type="checkbox"/>

Table 20 Model documentation, layout, and run time capabilities – requirements (cross check)

	Item	Comment	Checkbox
14.	<p>PSS®E model is coded in FORTRAN completely and no wrapper files have been used.</p>	<p>Note: Wrapper based models require special assessment by AEMO. AEMO should be contacted ahead of time to determine the additional requirements and assessments. Refer to Section 2.5 and Appendix A.2.</p> <p>Attention: If you click “No”, the DMAT process cannot commence. In this instance, and in the interest of minimising any complications for your project, it is advised not to submit studies and model information to AEMO for assessment purposes and not prior to AEMOs acceptance of models coded in language other than FORTRAN.</p>	Yes <input type="checkbox"/> No <input type="checkbox"/>
15.	<p>PSS®E model supports the following dynamic parameters (currently used by AEMO and AEMO reserves the right to change its run time data requirements for operational purposes):</p> <ul style="list-style-type: none"> • Acceleration Factor 0.2. • Tolerance 0.0001. • Frequency Filter 0.008. • Timestep (DELTA) 0.001. • Time step variation 0.001 to 0.01 s. • ITER variation 250-600. • Network Frequency Dependence. <p>Note: In general, the frequency filter time constant should be set to four times the integration time step (as a minimum). AEMO currently uses 0.008 as the filter time constant and requires models to conform to the latest modelling requirements which are used in real time production environment of OPDMS.</p>	<p>Models are expected to work for a range of the dynamic simulation parameters rather than for specific settings.</p>	Yes <input type="checkbox"/> No <input type="checkbox"/>
16.	<p>PSS®E model is a MINS type model. (for information only)</p>	<p>MINS models may be reviewed/accepted on a</p>	Yes <input type="checkbox"/> No <input type="checkbox"/>

	Item	Comment	Checkbox
		case-by-case basis, however in general found acceptable ³² .	
17.	For IBR, the PSS@E model is a user written model derived and validated from the actual equipment information (Type test or validation report provided)	AEMO requires user written models with all features and functions including settings and controls as per the actual firmware/controls.	Yes <input type="checkbox"/> No <input type="checkbox"/>
18.	For synchronous plant, the PSS@E/ PSCAD™/EMTDC™ models are sufficiently accurate representation of the actual plant (planned or) installed at the specific site under consideration.	Provision of evidence and/or model / setting mapping is required, including frequency response, control block diagrams etc. prior to commencing model acceptance tests/review.	Yes <input type="checkbox"/> No <input type="checkbox"/>
19.	For the PSS@E/ PSCAD™/EMTDC™ models: <ul style="list-style-type: none"> Using identical names should be avoided for models of similar structure to avoid e.g. linking problems, definition conflicts and/or model dependencies for wide area power system model integration. 	AEMO would advise of the need to change model naming as part of the assessment evaluation	Yes <input type="checkbox"/> No <input type="checkbox"/> Yes: the model conflicts with the pre-existing naming convention
20.	For wind turbine models (the PSS@E/ PSCAD™ / EMTDC™): <ul style="list-style-type: none"> The model includes electrical drive train, inertia and shaft stiffness. 		Yes <input type="checkbox"/> No <input type="checkbox"/>
21.	PSS@E model: <ul style="list-style-type: none"> The model must be written and prepared using good electricity industry practice and good model writing practices for the relevant software. For PSS@E, this would include: <ul style="list-style-type: none"> Execution of the DOCU command to show all model states, outputs and constants that are observable/adjustable externally. The output format of these commands to be consistent with the format of dynamic data. Execution of dynamic data documentation commands do not result in model crashing. Models must not include calls into either of the CONEC or CONET subroutines. In PSS@E this approach would require users to make a fresh compilation every time the network configuration changes, so a dedicated FORTRAN compiler is needed for each user. Using identical names should be avoided for models of similar structure where the number of one of the CONs, ICONs, VARs, or STATES is different between the two models. The model should comprise a single executable file for each physical plant. Use of auxiliary or linking files is discouraged. 		Yes <input type="checkbox"/> No <input type="checkbox"/> Yes: meets the requirements
22.	PSCAD™/EMTDC™ model is the actual Firmware compiled code.		Yes <input type="checkbox"/> No <input type="checkbox"/>

³² MINS models may be used instead or USRMDLs for plant level control taking into account multiple aggregates within the plant (and removal of dependency for CONEC calls).MINS models may be more advantageous to satisfy operational configuration validity requirement considering internal plant conditions (e.g. outage of one or multiple parts of the aggregate plant representation).

	Item	Comment	Checkbox
23.	For inverter-connected plant, PSCAD™/EMTDC™ model is of switching type (i.e. not average type) that explicitly models PWM switching.		Yes <input type="checkbox"/> No <input type="checkbox"/>
24.	PSCAD™/EMTDC™ model allows time step of 10 micro - seconds and higher .		Yes <input type="checkbox"/> No <input type="checkbox"/>
25.	PSCAD™/EMTDC™ has simulation speed of 90 real time seconds per simulation second, or less (as a reference taking into account 2.8 GHz processing unit).		Yes <input type="checkbox"/> No <input type="checkbox"/>
26.	Firmware version for the Model and Plant equipment is provided. ³³	For the Converter. Must be provided for IBR.	Yes <input type="checkbox"/> No <input type="checkbox"/>
27.	Firmware version for the Model and Plant equipment is provided.	For the Plant Controller. Must be provided for IBR.	Yes <input type="checkbox"/> No <input type="checkbox"/>
28.	Releasable User Guide must contain Instructions on how the model should be set up and used for: <ul style="list-style-type: none"> • PSS®E models, and • PSCAD™/EMTDC™ models. 	Equipment supplier information may be sufficient for this purpose initially, however, it does not substitute a requirement and information required for a Releasable User Guide which must be a site-specific document.	Yes <input type="checkbox"/> No <input type="checkbox"/> Yes: RUGs are provided Yes <input type="checkbox"/> No <input type="checkbox"/> Yes: OEM user guide is provided
29.	The models of the controllers and items of plant must be easily identifiable.		Yes <input type="checkbox"/> No <input type="checkbox"/>
30.	Open loop gain and phase margin plot and data is available and provided taking into account controller transfer function (i.e. impedance representation) coupled with the equivalent network representation at POC ³⁴ .	Most IBRs are expected to have completed and know design stability margins of their equipment.	Yes <input type="checkbox"/> No <input type="checkbox"/>
31.	The interconnection of the different functional controllers and the items of plant must be clearly shown (examples may relate to integrated resource systems , hybrid-generating systems with multiple technologies).	This could be supported with an overlay of the substation primary design, indicating what the measurement inputs and signal exchanges between different controllers and generating-production units are. In addition, all control modes must be shown and how they are switched from one mode to another including the dispatch logic.	Yes <input type="checkbox"/> No <input type="checkbox"/>

³³ Firmware versions may not be available for new technology prototypes which are yet to be manufactured. In this instance the manufacturer/model owner shall state on what basis has the model been released including evidence to substantiate its validation (e.g. type tests for a similar product, de-rated product and so on). Other examples for when firmware declarations are readily available include IBRs undergoing the settings or firmware change following the NER process.

³⁴ This is an admittance or impedance based approach with values covering both low to high end frequencies (e.g. 0.1Hz to 2kHz if available). This information is sought to support system studies and evaluation of stability margins. Discontinuity is expected at synchronous frequency due to positive sequence current source control.

	Item	Comment	Checkbox
32.	Model parameter values that are intended to be (or can be) externally adjusted (i.e., those explicitly in PSS®E and PSCAD™/EMTDC™ models must be clearly identified in the model block diagram.	This could relate to Power Reference or voltage reference, as an example.	Yes <input type="checkbox"/> No <input type="checkbox"/>
33.	For IBR, the model aggregation methodology proposed must be clearly specified. <ul style="list-style-type: none"> The aggregation method must not restrict access to the inverter terminals (LV side of the turbine transformer). The use of full feeder representation for one or more feeders is not considered good industry practice due to accompanying computational burden. It should not be used if possible unless there are requirements otherwise. 		Yes <input type="checkbox"/> No <input type="checkbox"/>
34.	For PSS®E models: <ul style="list-style-type: none"> The derivative of all state variables should be less than 0.0001 during initialisation. Models must be initialised successfully for the entire intended plant operating range. The model operating range must be consistent with the actual equipment design in particular with respect to the following: <ul style="list-style-type: none"> The entire range of active power. The entire range of reactive power/power factor (including limits of reactive power generation and consumption). The use of scripts is not acceptable. Specific conditions or any ‘corner points’ of the technical envelope must be clearly explained, represented in the RUG and corresponding documentation to enable the User of the model to setup and execute the model simulation run without reliance on any script. This could refer to and not necessarily limited to (examples where scripts are not acceptable): 1. Voltage control strategy and applicable coordination of operating devices within the plant, 2. Operating conditions which have active power, reactive power and voltage dependencies, 3. use and application of specific taps for different operating ranges, 4. Specific dispatch of power or reference signals, 5. Script for specific reactive power value for initialisation of the model etc. 		Yes <input type="checkbox"/> No <input type="checkbox"/> Yes, the model meets all the requirements.
35.	Models do not crash the software platform when model/plant is tripped or disconnected during the dynamic run.		Yes <input type="checkbox"/> No <input type="checkbox"/> Yes: model trips or disconnections do not result in numerically unstable behaviour causing the software platform to crash
36.	PSCAD™/EMTDC™ models must have snapshot capability.		Yes <input type="checkbox"/> No <input type="checkbox"/>
37.	PSCAD™/EMTDC™ models must initialise within 3 seconds for strong and weak networks (where snapshot capability is not enabled).	Models must be initialised successfully for the entire intended plant operating range. The model operating range must be consistent with the actual equipment design in particular with respect to the following:	Yes <input type="checkbox"/> No <input type="checkbox"/>

	Item	Comment	Checkbox
		<ul style="list-style-type: none"> The entire range of active power. The entire range of reactive power/power factor (including limits of reactive power generation and consumption). <p>If acceleration factors are used to aid the initialisation process, they shall be clearly identified and documented.</p>	
38.	PSCAD™/EMTDC™ models must allow stable initialisation and steady state run up to 5 minutes.	The maximum duration of the dynamic simulation run for which the model accuracy is proven should be clearly mentioned and evidence provided to substantiate it.	Yes <input type="checkbox"/> No <input type="checkbox"/>
39.	PSCAD™/EMTDC™ transformer model includes transformer specific saturation data where available ³⁵ (and not default model library provided settings).		Yes <input type="checkbox"/> No <input type="checkbox"/>
40.	Shortest time constant (name, use and identifiable in the control block diagram) confirmed for both PSS®E models and also PSCAD™/EMTDC™ models (for IBR plant, this applies to both converter and the plant controller).		Yes <input type="checkbox"/> No <input type="checkbox"/>
41.	PLL Settings and PLL Freeze/unfreeze setting values provided, including the control block diagram. PLL settings and outputs must be provided for all frequency measuring devices, especially where different frequency meters are used. Examples include PLL use (frequency estimation) for protective functions, PLL use for control functions, PLL use on wind turbine models on a machine side as well as the grid side converter. Where PLL is not used, a technology specific measurement and settings shall be provided and made available; for example, for grid forming technologies.		Yes <input type="checkbox"/> No <input type="checkbox"/>

The *Power System Model Guidelines* outline a range of model output quantities. The following quantities (in Table 21) may be additional, and specifically related to IBR (and where mentioned synchronous) plant.

Table 21 Required model output channels

	Item	Comment	Checkbox
42.	ID reference and IQ reference. (or applicable signals used as control references if ID and IQ references are not used. For example, for Grid	Converter/ Generating Production Unit Terminals, output channel.	Yes <input type="checkbox"/> No <input type="checkbox"/>

³⁵ Where data is not available during system design stage (S and D data categories), certain tests may need to be repeated to cross check the influence of transformer saturation. This may include and not limited to tests in section 3.2.4, 3.2.5, 3.2.6 to 3.2.9, 3.2.19 and so on with the main emphasis on the performance of the PSCAD™/EMTDC™ model. While it is understandable that factory tests or detailed data may not be available at time of DMAT assessment, application of appropriate transformer saturation data has been found critical on numerous NEM projects and may impact the design basis of affected plant and its performance acceptance. It is advised to collate this information earlier rather than later in the connection process.

	Item	Comment	Checkbox
	Forming Inverters, this could relate to voltage, power, frequency/angle, active and reactive current references where used)	If three phase control is used, then per phase ID and IQ references must be provided. Plants not utilising current reference control may be exempt from this requirement, for example, synchronous generators.	
43.	ID measured. IQ measured. I total measured. Note: Note: The converter/ generating-production unit current and/or MVA base used to generate current signals must be provided and explained. For IBR where Vd and Vq axis components are used, they shall be made available to aid verification (together with Id and Iq) of active and reactive power measurements.	Converter/ Generatg Production Unit Terminals, output channel. For synchronous plants, this applies to both LV terminals and at Point of Connection.	Yes <input type="checkbox"/> No <input type="checkbox"/>
44.	ID measured. IQ measured. I total measured.	Point of Connection. [maximum <i>per unit current</i> of the generating-production unit (converter) is related to the connection point voltage/location. Thus, the total current may not be taken as reactive power capability 'negotiated' in S5.2.5.1. which may depend on adequacy and design of capacitive reactive plant or the main transformer tap changer design, as an example].	Yes <input type="checkbox"/> No <input type="checkbox"/>
45.	Frequency measured.	Converter/ Generatg Production Unit Terminals, output channel. Applies to synchronous and IBR plant.	Yes <input type="checkbox"/> No <input type="checkbox"/>
46.	Frequency measured.	Point of Connection/ Plant Controller.	Yes <input type="checkbox"/> No <input type="checkbox"/>
47.	FRT (LVRT) Flag [ON/OFF status]. Including FRT activation/deactivation for negative sequence FRT.	Converter and Plant Controller (if used).	Yes <input type="checkbox"/> No <input type="checkbox"/>
48.	HVRT Flag [ON/OFF status].	Converter and Plant Controller (if used).	Yes <input type="checkbox"/> No <input type="checkbox"/>
49.	Additional requirements for wind turbines: <ul style="list-style-type: none"> • Pitch angle. • Wind speed. • Generator rotor speed. • Mechanical torque/power. • Aerodynamic torque/power. 		Yes <input type="checkbox"/> No <input type="checkbox"/>
50.	For synchronous machines (including synchronous condenser): <ul style="list-style-type: none"> • Field current. 	Additional requirements may apply for MFRT assessments, for example, pole slip protection elements.	Yes <input type="checkbox"/> No <input type="checkbox"/>

	Item	Comment	Checkbox
	<ul style="list-style-type: none"> • Field voltage Limiter outputs. • Mechanical power or torque Rotor angle. • PSS output. • Unit speed. • AVR output. • Exciter output. • Valve position. • Guide vane/needle positions. • Governor control output. • Set-point for active power. • Set-point for voltage. • External protection relay(s). 		
51.	<p>Negative sequence voltage and negative sequence current (provided as a calculated plot channel) at generating production unit and generating system/integrated resource system terminals including:</p> <ul style="list-style-type: none"> • Negative sequence current control reference at IBR LV terminals • Hysteresis for activation deactivation • Current Limits 		Yes <input type="checkbox"/> No <input type="checkbox"/>
52.	<p>Protection fFlags, pickup and activation times including settings for MFRT:</p>	<p>All protection Flags (and description of each). Provision of just one overall protection flag as a summation of all internal flags will not be sufficient.</p> <p>Applies to synchronous and IBR plant.</p>	Yes <input type="checkbox"/> No <input type="checkbox"/>
53.	<p>Self assessment is completed and all output files provided for review as per Appendix A.2 Table 22</p>	<p>Report and output files.</p> <p>Report must outline technical reasoning for excluding other tests contained within the Guideline.</p>	Yes <input type="checkbox"/> No <input type="checkbox"/>

Appendix B. Frequently asked questions

Does DMAT apply to both PSS®E and PSCAD™/EMTDC™?

Yes, the DMAT consists of three parts in relation to models:

- PSS®E.
- PSCAD™/EMTDC™.
- Benchmarking between PSS®E and PSCAD™/EMTDC™ for balanced events and control actions/performances for all tests in this DMAT other than unbalanced events.

Is the DMAT site-specific?

The DMAT is site-specific (and firmware-specific) and test outcomes are not re-usable from project to project.

Where does DMAT sit in the connection process?

This is a high-level outline of model acceptance stages during the connection process:

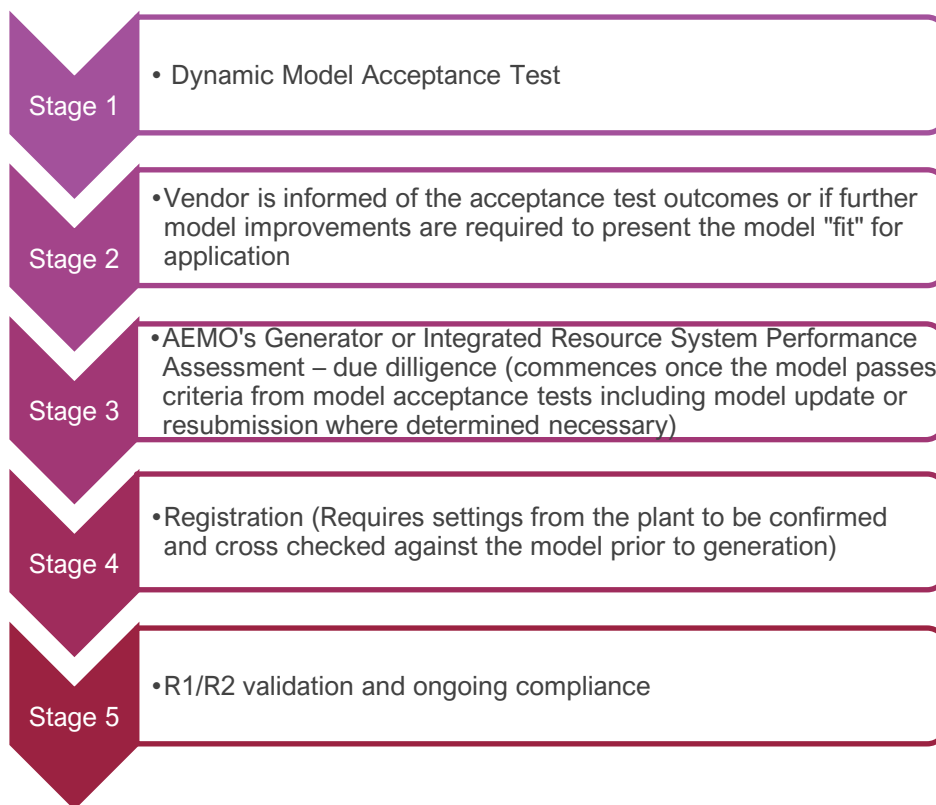

As a Developer-Applicant, when should DMAT be performed, and what should I do if no preferred supplier has been selected?

To minimise risks associated with multiple R1 data, and to mitigate potential mis-design assessment associated with unchecked model and inconsistent setting information (RMS and EMTP models), AEMO advises performing DMAT as soon as the following are achieved:

- The connection point is known, and the project development is mature enough to select the type of technology and its generating system or integrated resource system size/ once the shortlist of suppliers is known.
- Preliminary **Impact** Assessment is completed that supports the findings of the lowest applicable SCR at the proposed connection point.
- All required pre-requisite information, included in the checklist, has been prepared and checked by the Proponent or the vendor.

How long would it take to complete DMAT?

Completion of the DMAT is dependent on many factors emanating from the quality, due diligence, and validation of information prepared by the vendor/proponent.

There are two important aspects to DMAT:

- (a) Obtaining the results and information, and
- (b) Interpreting the results.

AEMO uses various automation scripts to accelerate the delivery of results, however, from AEMO's past experience, DMAT delays are usually caused by inadequacies in the modelling, insufficient verification of consistency or unvalidated performance, requiring additional time and effort to understand, settle and rectify. Another common contributor to delays in the completion of performance evaluation is the lack of access to expertise and/or reliance on answers from vendors' overseas-based locations.

What happens if the generating system or integrated resource system has multiple technologies, or if there are changes in the plant design?

New plant may be added due to a need to overcome compliance shortfalls, or new equipment may be added pre- or post-energisation. As an example, this could include:

- (a) Determining the size of STATCOM, SVC, or synchronous condenser, which would be feasible only after the technical assessment studies are undertaken.
- (b) Addition of a battery storage system to an existing generating system or integrated resource system.
- (c) Change in supplier or technology.

In these cases:

- A separate DMAT would be carried out for the additional plant on its own when such model information becomes available.
- A DMAT would also be carried out for the combined generating system or integrated resource system representation.

Therefore, the DMAT applies to the individual (technology-specific) plant components, as well as the combined generating system or integrated resource system representation – DMAT for each component is carried out first, and, thereafter, for the combined generating system or integrated resource system.

In a hybrid system, equipped with a combination of wind turbines, solar PV, and/or battery systems, STATCOM, synchronous condensers, a combined DMAT would be carried out, for example:

- DMAT for the battery system (charging and discharging).
- DMAT for the wind turbine.
- DMAT for the solar PV.
- DMAT for the STATCOM and/or synchronous condenser.
- DMAT for the combined system (with battery charging and discharging).

Is the complete PSCAD™/EMTDC™ parameter list requested for the ‘Releasable User Guide’?

No, although the proponent/Generator/Integrated Resource Provider could suggest these be included for AEMO’s review. The parameter list would be embedded in the encrypted model itself. Otherwise, the “complete” parameter list is to be provided to AEMO (nominated person) from the OEM owners Engineer or the Participant/Intending Participant.

Is a type test or laboratory (converter module) test required?

Yes, a type test and validation of type test data against PSS@E and PSCAD™ models is required.

AEMO acknowledges that certain technologies may be in the so-called “prototype” stages, and that a type test report may not be available at time of the DMAT assessment. In this instance, AEMO would request and require evidence from the vendor to explain the basis on which the supplied model can be used, how has it been validated, and what quality checks have been done by the supplier to approve release of the model. This applies to both synchronous (for example transfer function of the AVR/PSS system) and IBR technologies. In absence of the type test, for inverter-based technologies, AEMO requires a laboratory test in consideration of either total converter current rating or module test (for example, via Real Time Digital Simulator [RTDS] or equivalent platform where real-time results can be validated).

Ultimately, use and application of non-validated models creates risk, associated with and not necessarily limited to:

- Rejection of the model.
- Plant design or mis-design.
- Plant compliance/study evaluation (for example, Full Impact-Assessment).
- Assessment of power system security and/or constraints that AEMO may invoke (or request the system test under the NER at the cost of the Generator/Integrated Resource Provider).
- Impact on studies progression, GPS, Registration, and operation (for example, during commissioning).

In cases where evidence is not available for the exact firmware version of the product, where reasonable, such evidence may be supported by using tests for a similar type or size of the equipment. In general, stating that the models and model parameters are a 1-to-1 match with the equipment would be insufficient to satisfy validation requirements.

Is validation required which demonstrates the lowest SCR which the equipment can sustain?

Yes, AEMO requires a validation result to be provided, together with evidence (validated FRT responses from the type test, FAT or HIL test) and reasoning including the settings for SCR limitations.

Is FRT validation for balanced and unbalanced faults/disturbances required?

Yes.

Is validation of multiple FRT required?

Yes, AEMO requires validation results to be provided, together with evidence (actual validated FRT responses from the type test, FAT or HIL test) and reasoning for its multiple FRT limitations.

Do models need to have protective elements included for multiple FRT assessment?

Yes, as outlined in the *Power System Model Guidelines*.

Would AEMO accept a statement from the equipment supplier as an exemption from including the protective mechanisms in the model?

In general, no. AEMO is aware that there may be aspects which may not be pragmatically implementable in the model itself. This could be understood once necessary details are provided to AEMO for a review.

An example of an unacceptable response is the equipment supplier claiming capability which requires a few seconds' time between recurring events, when model evidence to support such a claim does not have sufficient details to validate the technical foundation of such a statement.

Is there an implication if a vendor's PSS®E model is not source coded in FORTRAN?

Yes – non-FORTRAN models cannot be accepted unless pre-approved by AEMO. Feasibility assessments may be conducted by agreement, in advance of model submission, but will involve additional risk and cost.

Please refer to section 2.5 of this guideline, which contains important information and considerations for proponents and vendors.

Would DMAT be required for an existing plant undergoing settings or plant change?

Yes, the entire DMAT or parts thereof would be undertaken as AEMO considers appropriate, depending on the nature of the change. In the first instance, certain aspects of the DMAT could be covered by the Proponent to ensure that changes are reflected across both PSS®E and PSCAD™/EMTDC™ models and checked for consistency and accuracy.

Use and application of control modes – what control mode shall be applied in the DMAT?

MATs shall be undertaken with the default control mode being the voltage control mode. If the plant is to operate in a mode other than the voltage control mode, then the bulk of tests shall be undertaken with such control mode unless tests specify otherwise.

Treatment of exemptions – would exemptions be allowed?

AEMO may agree to exemptions from the requirement to provide information or complete specific pre-submission tests in appropriate circumstances, for example:

- The required information is not applicable to the type of technology in question.
- A repeat of a complete DMAT may not be required subject to the vendor or proponent satisfactorily confirming changes (via suitable evidence), or updates to models or settings do not warrant repeat of the entire DMAT or parts thereof.
- Provision of an FRT type test for a large Synchronous Generator where it is reasonably impractical to achieve such prior to installation
- Provision of an FRT type test for a prototype wind turbine which is yet to be tested by the OEM. In this instance, evidence for a similar type turbine must be provided, including evidence which substantiates the model accuracy or methodology deployed to validate/approve the model prior to its use.
- The plant is exempt from model provision, for example, for ratings less than 1 MVA unless determined otherwise, for example, the need to model and include details of DER devices.

B.1 FAQs added November 2021

Does the DMAT Guideline improve model quality?

The acceptance tests outlined in the DMAT Guideline are designed to verify that plant models are fit for purpose. All NEM-connected plant should be able to be modelled reliably, consistently and accurately for the full range of assessments and studies that AEMO or NSPs need to conduct to perform their functions. This requires confirmation of (among other things): model robustness, numerical stability, initialisation, validity, speed, levels of modelled information inclusion, applicable settings transparency, and requirements for integration into OPDMS and PSCAD wide area network models.

If models do not meet these standards, there will be a negative impact on planning and operation of the NEM and its component networks and generating system [or integrated resource system](#). This adversely impacts new investors, existing participants and ultimately consumers, so it is fundamentally important to get modelling right. AEMO appreciates the cooperation and commitment of proponents, vendors and NSPs to continuous improvement of power system models.

Which part of the NER does the DMAT Guideline relate to?

The Power System Model Guidelines (PSMG), made under clause S5.5.7(a)(3) of the NER, outlines a number of requirements that need to be met for model confirmation.

The DMAT Guideline has been developed to provide visibility of the specific model acceptance tests, and to assist proponents and vendors' understanding of:

- the specific criteria for a model to meet the PSMG requirements; and
- how to demonstrate the model meets those requirements.

When does the DMAT Guideline apply?

Any time a model, or updated model, is required to be provided to the NSP and AEMO in connection with a process or obligation under the NER, it should be submitted to the NSP and AEMO for DMAT assessment unless otherwise agreed with AEMO.

Do Proponents have to complete all the scenarios/tests in the DMAT Guideline?

No, the DMAT Guideline sets out the full list of scenarios and tests to be conducted. By itemising all of them, the DMAT Guideline allows proponents to self assess their models and, if necessary, to fix both undesirable and/or unexpected performance prior to being assessed by the NSP and AEMO.

AEMO and NSPs may assess all aspects of the DMAT that are relevant to the model submitted for assessment. The Guideline does not require proponents to complete all the identified tests themselves prior to submission, but it is the proponent's responsibility to demonstrate that the model meets the PSMG requirements. AEMO can reject a model if insufficient evidence is provided.

In the interests of efficiency, this Guideline therefore includes a **minimum** set of tests that must be performed before submitting a model for DMAT assessment. However, AEMO (or NSPs) can always request the proponent to complete more tests and provide results as needed to complete the DMAT assessment.

What is the benefit to Proponents in completing more tests?

The more tests proponents can conduct themselves, the more they will reduce the risk, delay and expense of model issues being identified late in the connection process.

If not all tests, then which tests need to be completed and submitted?

AEMO has specified (Table 22) the **minimum** mandatory tests from the DMAT Guideline that we expect to be conducted and reported by the proponent as part of its DMAT submission. It is expected that the tests in Table 22 will be reviewed regularly and may be expanded or changed with the benefit of operational experience.

AEMO cannot accept a model for DMAT assessment without inclusion of the results of these tests, at least. AEMO may request the proponent to conduct and provide the results of additional or repeat DMAT tests, and/or undertake them itself.

Proponents should carefully consider the potential risks of limiting their self-assessment to these minimum requirements. The more tests proponents can conduct themselves, the more they will reduce the risk, delay and expense of model issues being identified late in the connection process.

What if I decide not to complete all DMAT Guideline tests in my self-assessment?

Proponents must complete at least the minimum tests listed in Table 22, for AEMO to accept the model for assessment.

If a proponent and/or their vendor decide not to complete the full suite of DMAT studies applicable to the plant model (in addition to the minimum tests), the submission should include a technical report explaining why the excluded tests were considered unnecessary or inapplicable. Considerations may include, without limitation, network location, stability, plant design or configuration, size, whether initial tests indicated oscillatory responses, etc.

What exactly do I need to submit with my model?

The DMAT checklist (Appendix A.1 of the DMAT Guideline) must be submitted by the proponent with all supporting information.

Evidence of completion of self-assessment tests, including the minimum mandatory tests noted in Table 22, is expected to be submitted as a report including all test results and **respective output files**³⁶ on request.

It is important for the proponent to focus on engineering/model checks and rectification of model issues including inconsistencies prior to providing information to AEMO to commence the review and model acceptance testing. Appendix 3 outlines some of the typical model encountered issues that should be rectified prior to provision of DMAT self-assessments and model information to AEMO.

Could DMAT results be repurposed or generalised?

It is possible to reuse DMAT results considering testing at different SCR and X/R values where generalised tests are provided (e.g. at SCR of 3 and 10 and X/R of 3 and 14 as used throughout this Guideline). They can be used to support site specific tests which must be done on a project specific basis, using project specific SCR and X/R conditions. Verification would need to take place to establish that applied models remain unchanged from their source and settings. Provision of models, controls and settings which have not been verified, creates a need to expend more resources, additional due diligence and exposes projects to delays. This is most often seen with model updates, e.g.:

- Updates to technology and ratings (e.g. new wind turbine prototypes, batteries, solar inverters)
 - Updates in firmware and model source codes affecting the inverter and / or the plant controller (as an example)
 - Updates to bug fixes and settings affecting the control system performance
 - Update or enablement of specific control functions/settings
 - Robustness of model differences (performance) subject to system strength/settings and numerical simulation environment.

To overcome the shortcomings of generalisation, this DMAT requires evaluation of POC specific conditions and a range of SCR and X/R values taking into account the latest model releases. Therefore,

³⁶ Output files allow use of adequate plotting tools and zoom in functionalities in improving legibility (e.g. from *.png or *.pdf plots that are typically submitted to AEMOs or NSPs) and review of model behaviour.

generalisation of the DMAT is not recommended considering the pace of change in the network topology, and constantly changing and improving OEM features, functions and settings.

Table 22 List of minimum mandatory tests for self assessment (Continuation of DMAT Checklist)

	DMAT Test Number	Comment	Checkbox	
54.	0.1 to 0.4	Flat run, snapshot and initialisation test at POC	Yes <input type="checkbox"/>	No <input type="checkbox"/>
55.	37, 43, 49, 55, 61, 67, 73, 79, 85, 91	Unbalanced fault – large disturbance test cases Performed at the Point of Connection, applicable SCR level. As per DMAT- total current and its reduction (if any) must be checked and presented including settings. Manufacturer declared settings for treatment of asymmetric events, negative sequence fault logic, activations, deactivation, and (controlled current) limitations must be provided prior to application of unbalanced faults.	Yes <input type="checkbox"/>	No <input type="checkbox"/>
56.	121 – 122	MFRT random event selection for EMTP model test	Yes <input type="checkbox"/>	No <input type="checkbox"/>
57.	126 – 127	MFRT random event selection for RMS model test	Yes <input type="checkbox"/>	No <input type="checkbox"/>
58.	137, 146	TOV test case	Yes <input type="checkbox"/>	No <input type="checkbox"/>
59.	153, 159, 165	Voltage and Reactive Power (and/or PF) control reference step change test	Yes <input type="checkbox"/>	No <input type="checkbox"/>
60.	169	Active Power Controller Reference step change test	Yes <input type="checkbox"/>	No <input type="checkbox"/>
61.	170-177	Grid frequency controller test	Yes <input type="checkbox"/>	No <input type="checkbox"/>
62.	180-181, 184-185, 188-189	Grid voltage response test	Yes <input type="checkbox"/>	No <input type="checkbox"/>
63.	190, 191 (up to and including 25Hz)	Grid oscillatory rejection test	Yes <input type="checkbox"/>	No <input type="checkbox"/>
64.	197	Grid phase angle response test (for $\pm 40^\circ$)	Yes <input type="checkbox"/>	No <input type="checkbox"/>
65.	199	SCR = 1: Active power reference change test	Yes <input type="checkbox"/>	No <input type="checkbox"/>
66.	200, 203	SCR=1- FRT Test	Yes <input type="checkbox"/>	No <input type="checkbox"/>
67.	206 -225	FRT Benchmarking for POC SCR and X/R Conditions	Yes <input type="checkbox"/>	No <input type="checkbox"/>
68.	226, 228	Input power source step change (for example, wind speed, irradiance)	Yes <input type="checkbox"/>	No <input type="checkbox"/>
69.	3.6.1 – case study 1	For synchronous generating systems only. Full load level and minimum load level	Yes <input type="checkbox"/>	No <input type="checkbox"/>
	3.6.2- case study 2	For synchronous generating systems only. Full load level, 5% Vref step into UEL and OEL	Yes <input type="checkbox"/>	No <input type="checkbox"/>
70.	Full DMAT scope	Any (other) tests or DMAT requirement that AEMO/NSP may find necessary for any specific project shall be provided or undertaken for assessment.	Yes <input type="checkbox"/>	No <input type="checkbox"/>
			Yes, other tests are included. No, other tests are not included.	

Appendix C. Selected examples and issues

This section lists some examples of **unacceptable** model responses including model related issues and lack of information regarding the control system functions, limitations and applicable settings impacting consistency between the models, numerical robustness and questionable validity of models. These anonymised examples represent a small subset of actual issues AEMO has encountered in many reviews of power system model information.

These do not represent the full spectrum of possible unacceptable model behaviour, and are intended only as an indicative guide for proponents and vendors to highlight some of the more common issues and deficiencies to be avoided or addressed prior to submission.

Figure 16 PSSE and PSCAD benchmarking inconsistency and instability in the DQ reference frame for an IBR plant

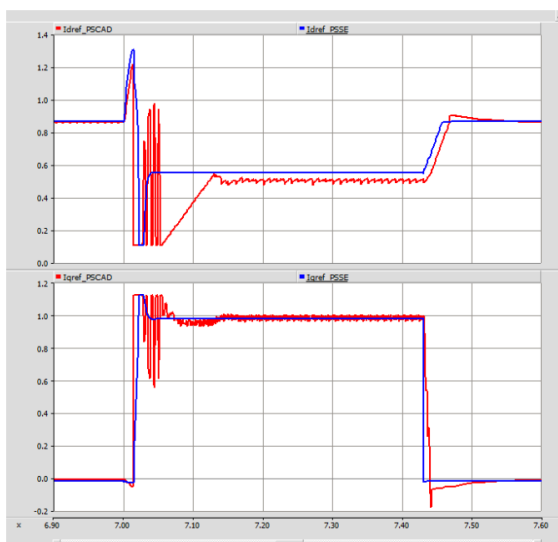

Figure 16 shows an example of an issue observed for an IBR plant showcasing instability and inconsistency of the model/plant. In this instance, the IBR model evaluation was done (consistent with one of the DMAT tests in this Guideline) in a fairly robust part of the system with high short circuit influence represented via simplified Thevenin equivalent source.

Figure 17 PSSE and PSCAD benchmarking results for one selected fault in this DMAT Guideline. D axis current comparison. (The second plot shows zoomed in response of the “spike” signal)

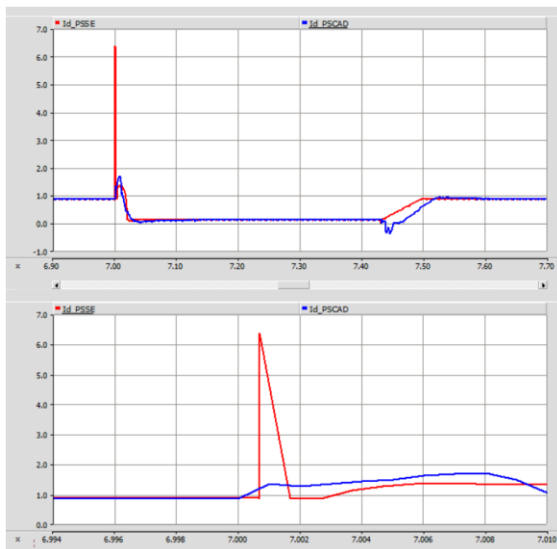

Figure 17 provides an example of poorly coded MODE2/MODE3 aspects in PSSE exposing the numerical/robustness integrity of the PSSE model provided to AEMO. In this instance active current spikes to a value of nearly 6 pu in a single time step. These issues are solvable via adequate rectification and improvement of the PSSE source code and are identified via application of tests in this Guideline.

Figure 18 Active and Reactive Power benchmarking inconsistency for RMS quantities

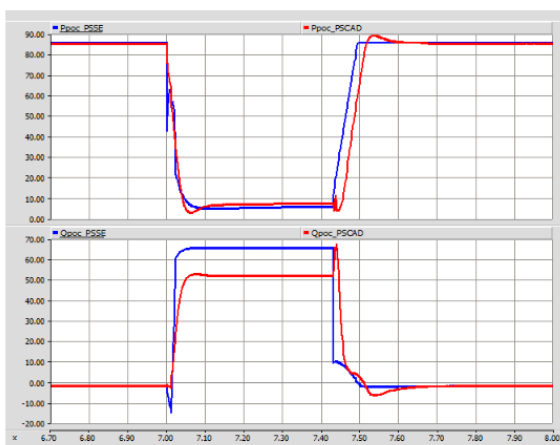

Figure 18 shows an example of inconsistent model behaviours during the FRT performance and balanced voltage disturbance tests under this Guideline. It is important for models to be cross checked, validated and issues rectified prior to provision to AEMO. To assist with these matters, a checklist of validations and LVRT tests are included in this Guideline considering application of balanced and unbalanced disturbances.

Figure 19 PSCAD Example of the post fault response considering time step change in the proponent provided model (existing connection in the NEM)

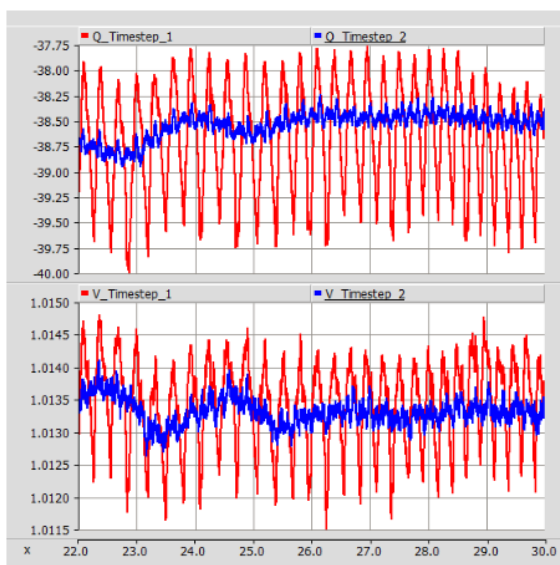

Figure 19 shows a difference in modelled responses using different proponent/vendor recommended time steps for the model. The implications arising as a result of lack of evidence, confidence and sufficient work (testing and validations by the vendors) in this area are likely to implicate system strength remediations both technically and commercially, increase system security risks/uncertainties, impact interpretation of compliance, operational outage planning assessments where Generators or Integrated Resource Providers may be requested to disconnect their system and so on. This DMAT includes a checklist of information for fundamental justifications of model validity, and evidence to the effect of different time step requirements, recommendations or assumptions used, including validation of tests for LVRT, low SCR, MFRT, frequency rejection tests, and tests at different SCR and X/R levels to name a few.

Figure 20 An example of a modelled response for one unbalanced fault

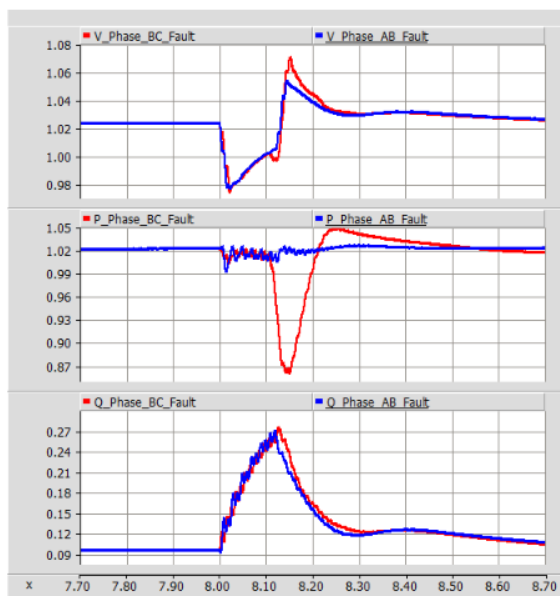

Figure 20 shows an example of a 2 phase to ground [2PHG] fault application resulting in different responses for the provided model; 2PHG fault in phases AB has different responses for a 2PHG fault in phases BC. While this is a model/functional driven issue (also present in the real plant), it has also exposed the control system integrity of undeclared settings, control systems and limitations that are present during unbalanced events. These aspects must be declared to AEMO as well as reflected in the GPS. On this occasion, these responses were not accepted, and equally, the tests in this DMAT don't specifically capture this situation, demonstrating that the DMAT defined tests do not, and should not restrict AEMO nor the proponent from undertaking additional tests. The DMAT includes a variety of fundamental tests for unbalanced events and specific requirement for information considering actions of control systems for asymmetrical or unbalanced faults, negative sequence FRT logic or reduction factors that must be declared prior to model assessment and acceptance of such functions/limitations/performances.

C.1 Other examples of deficient models

- Models which do not meet AEMO's requirements for initialisation and snapshot functionalities
- Models which draw excessive amount of MVARs for initialisation and thus collapsing the system voltage in the vicinity of their connection
- Models which do not work and do not follow PREF targets
- Models resulting in non-convergences
- Models which use filtering (e.g. with excessive time constants) at connection point to smooth out the "true" performance characteristics of the model/plant
- Models in PSSE which bounce between +1 and -1 PU active power during and following system SMIB tests

- Models not provided to AEMO with all required files to enable execution/run time resulting in lost hours
- PSCAD™/EMTDC™ models requiring manual copying of library files
- Models provided to AEMO with settings for a 60Hz system connections
- Models which have incorrect transformer winding voltages and vector group orientation
- Models which are oscillatory unstable, and despite which are still provided to AEMO for feedback.
- Models which use scripts
- Models which are based on wrapper files for PSSE
- Models which do not have protective functions implemented (even basic voltage and frequency settings)
- Models which do not have reactive current limitations
- Models which do not conform to AEMO's dynamic solution parameters
- Models which collapse on application of any fault on a SMIB
- Models which apply reductions in outputs due to asymmetrical events without settings and control system declarations of such limitations.

Conformance to the PSMG and the information in this DMAT Guideline is critical for assessing and confirming model acceptance. Many of the tests in the DMAT Guideline were developed by drawing on the experience of these and other difficulties and successes across multiple projects.

Abbreviations

Abbreviation	Term
AVR	automatic -Automatic voltage regulator
DER	Distributed Energy-energy Resourceeresource
DSA	dynamic -Dynamic security assessment
EMT	e Electromagnetic transient
EMTP	E electromagnetic transient program
FSFC	Full scale frequency converter
FRT	F fault ride-through
HVDC	H high voltage direct current
HVRT	High Voltage-voltage Rride Throughthrough
Hz	Hertz
IBR	Inverter based resources (inclusive of all asynchronous and grid forming network devices (other than conventional synchronous machines)). This includes batteries, SVCs, STATCOMs, Wind Turbines and PV solar systems, HVDC etc.
LVRT	L low voltage ride-through
MAT	M model acceptance test
MFRT	M multiple fault ride-through
mHz	M millihertz
ms	Milliseconds
MVA	M megavolt amperes
NEM	National Electricity-electricity Market-market
NER	National Electricity-electricity Rulesrules
NSP	N network service provider
OEM	Original Equipment-equipment Manufacturermanufacturer
OPDMS	Operations and Planning-planning Data-pata Management-management System-system
PCC	P point of common coupling
PF	p Power factor
PI	P roportional integral
PLL	P hase lock loop
POC	p Point of connection
POD	P power oscillation damper
PSS	P power system stabiliser

Abbreviation	Term
pu	<u>P</u> er unit
PV	<u>p</u> h P otovoltaic
RMS	<u>R</u> oot mean square
SCR	<u>S</u> hort circuit ratio
SMIB	<u>S</u> ingle machine infinite bus
STATCOM	<u>S</u> tatic synchronous compensator
SVC	<u>s</u> Static Var compensator
TCR	<u>T</u> h t yristor controlled reactor
TSC	<u>T</u> h t yristor switched capacitor

Version release history

Version	Effective date	Summary of changes
3.0	3/06/2024	Updates to reflect National Electricity Amendment (Integrating energy storage systems into the NEM) Rule 2021.
2.0	26/11/2021	<p>Revised after operational experience in response to requests for clarification from industry and NSPs:</p> <ul style="list-style-type: none"> • Purpose statement updated (in Important Notice) to clarify DMAT application • Table 2 updated to reflect POC conditions for initialisation and snapshot checks • Section 2.5 and checklist (A1, Table 20, item 14) updated to highlight implications of submitting non-FORTRAN source coded models for PSS®E (not advisable). • Update to section 2.2 to clarify initialisation cannot rely on scripts. Checklist in A.1, Table 20, item 34 (bullet point 3) also confirms use of scripts not permitted. • Footnote update to Table 20, item 16 (use of MINS models), item 26 (firmware versions), item 39 (transformer saturation). • Clarification and a footnote update to Table 20, item 30 (open loop gain and phase margin information) • Unbalanced faults updated in section 3.2.5 Table 4 to reflect the most relevant (minimal) POC conditions of interest for assessment of asymmetrical disturbances. • Clarification of fault duration in “note A” for Test 121 (section 3.2.6). • Correction of error for Tests 227 and 229 - signage of input source step application (section 3.2.20) . Test 155, corrected to reflect 1.0 pu active power output. • Clarification note added for tests 193 to 198. • Figure updates for excitation limiter tests in section 3.6.1 • Appendix A.2 updated with clarifications to existing FAQs, additional FAQs, and list of minimum tests for self-assessment prior to DMAT submission (also referenced in section 2.6). • New Appendix A.3 – Selected examples and issues.
1.0	17/2/2021	First issue after consultation with NEM Power System Model Reference Group (PSMRG)