

Project EDGE

Bi-Directional Offer (Boffer) For Wholesale Energy

Options for aggregators to participate in off-market wholesale dispatch – high level design document

June 2023

Developed with the support of:



Important notice

PURPOSE

The purpose of this document is to provide high level overview of the Bi-directional Offer functionality in the Project EDGE DER Marketplace for the project participants and platform vendors. This document has been prepared by Project EDGE team.

DISCLAIMER

This document or the information in it may be subsequently updated or amended. This document does not constitute legal, business, engineering or technical advice, and should not be relied on as a substitute for obtaining detailed advice about the National Electricity Law, the National Electricity Rules, or any other applicable laws, procedures or policies. AEMO has made every effort to ensure the quality of the information in this document but cannot guarantee its accuracy or completeness.

Accordingly, to the maximum extent permitted by law, AEMO and its officers, employees and consultants involved in the preparation of this document:

- make no representation or warranty, express or implied, as to the currency, accuracy, reliability or completeness of the information in this document; and
- are not liable (whether by reason of negligence or otherwise) for any statements or representations in this document, or any omissions from it, or for any use or reliance on the information in it.

COPYRIGHT

© 2022 Australian Energy Market Operator Limited. The material in this publication may be used in accordance with the [copyright permissions](#) on AEMO's website.

ARENA ACKNOWLEDGEMENT AND DISCLAIMER

Project EDGE received funding from ARENA as part of ARENA's Advancing Renewables Program. The views expressed herein are not necessarily the views of the Australian Government, and the Australian Government does not accept responsibility for any information or advice contained herein.

DISTRIBUTION

Available to the public.

DOCUMENT IDENTIFICATION

Business Custodian: New Markets Services

Prepared by: Project EDGE Team

Last update: Wednesday, 21 June 2023 5:08 PM

VERSION CONTROL

Version	Release date	Changes
Final	30/06/2022	Final version of the document incorporating stakeholder feedback.
June 2023	9/06/2023	<ol style="list-style-type: none"> 1. Minor updates including expanding on concepts and descriptions in the document including formatting (font size, indentation, image and table title). 2. Updated Dynamic operating envelope or (DOE) to Operating Envelop or (OE); removing reference to dynamic in OE 3. Addition of <ol style="list-style-type: none"> 3.1. Purpose under Important notice on Pg. 1 3.2. Examples of controllable DER assets in Sec 4.2.2 Controllable (or Flexible) Assets 3.3. Details on the Boffer design and structure in Section 4.2.3 Boffer Structure and Band Availability 3.4. Table describing Boffer components in section 4.2.3 Boffer Structure and Band Availability 3.5. Introduction and description of Figure 7 Supply Chart in Section 4.6 Boffer Characteristics 3.6. Updated links in Appendix A: Relevant reading 3.7. Description of D1. Generation Offer in Appendix D. Existing Bod and Offer example 3.8. Description of D2. Load Bid in Appendix D. Existing Bod and Offer example 3.9. Description of D3 Bi-directional Offer in Appendix D. Existing Bod and Offer example 3.10. Renamed E.2.1 to Load Boffer Example – NMI 3.11. Renamed E.2.3 to Load Boffer Examples – FLEX 3.12. Renamed F.2.1 to Generation Boffer – NMI 3.13. Renamed F.2.2 to Generation Boffer – FLEX 3.14. Renamed G.2.1 Bi-directional Boffer - NMI 3.15. Renamed G.2.2 Bi-directional Boffer - FLEX

Contents

1	Purpose	5
1.1	Purpose of the document	5
1.2	What is a Boffer	6
1.3	Boffer and other functions	6
2	Design principles & priorities in relation to Boffer	7
3	Design Options analysis	8
4	Proposed design	9
4.1	In Scope & Justification	10
4.2	Key Concepts	12
4.3	Boffer Progression Step 1: Visibility	16
4.4	Boffer Progression Step 2: Self-dispatch	17
4.5	Boffer Progression Step 3: Scheduled	19
4.6	Boffer Characteristics	20
4.7	Boffer Rules	22
4.8	Out of Scope	23
5	Linkages to NEM reforms	24
Appendix A. Relevant Reading		26
Appendix B. Glossary		27
Appendix C. Scheduled Loads - Current bid structure		29
Appendix D. Existing Bid and Offer Example		31
D.1	Generation Offer	31
D.2	Load Bid	34
D.3	Bi-directional Offer (Boffer)	36
Appendix E. Load Boffers		38
E.1	Portfolio Configuration	38
E.2	Load Assets: 100 kW load with 30 kw controllable load	40
Appendix F. Generation Boffers		50
F.1	Portfolio Configuration	50
F.2	Generation: 60 kW flexible Generation with 70 kW native load	52
Appendix G. Bi-directional Portfolio		57
G.1	Portfolio Configuration:	57
G.2	Bi-directional: 60 kW flexible generation, 50 kW controllable Load and 40kW base load	59

Appendix H. DUID Telemetry Data Measurements	62
H.1 DUID Telemetry: Net Load Portfolio	63
H.2 DUID Telemetry: Net Generation Portfolio	66
H.3 DUID Telemetry: Battery Charging	69
H.4 DUID Telemetry: Battery Discharging	70

Tables

Table 1	Boffer component description	14
Table 2	Participate in Visibility Only	17
Table 3	Participate as 'Self Dispatch'	18
Table 4	Participate as fully Scheduled	19
Table 5	DER Asset Capacity – Load Boffer example	39
Table 6	DER Asset Capacity	51
Table 7	DER Asset Capacity	58

Figures

Figure 1	Spectrum of approaches for Aggregator participation in wholesale dispatch	8
Figure 2	Boffer proposed design and progression	9
Figure 3	Sample site with Energy Storage System (Battery) and rooftop solar (PV)	13
Figure 4	Boffer structure	14
Figure 5	Sample Boffer file	14
Figure 6	Sample Boffer – Accumulation 'On' and Accumulation 'Off'	21
Figure 7	Sample Boffer – Supply Chart	22

1 Purpose

1.1 Purpose of the document

This document outlines the High-Level Design for various Bi-directional Offer or Boffer options, a function set to be tested in Project EDGE. For broader context and information about Project EDGE, please visit the [AEMO website](#).

EDGE will trial Boffers (in an off-market environment) as a mechanism to understand how Aggregators could participate in a wholesale market dispatch process to test their ability to deliver services at wholesale level (i.e., 'Energy') and local level (i.e., distribution network).

Aggregator participation in wholesale dispatch is required to address the following:

- **Problem statements**
 - **Risk of inefficient wholesale market operation in high DER future**
 - DER proliferation is causing distribution network power quality challenges
 - Static governance of network connections limits customer access to available network capacity for DER activities
- **Relevant Project objective**
 - **Wholesale Market participation enabled at scale:**

Demonstrate how DER fleets could participate in existing and future wholesale energy markets at scale. Project EDGE is seeking to test and demonstrate the concepts to enable an efficient DER Marketplace.
- **Relevant Research Question**
 - **Wholesale Integration - RQ4:** How can the DER Marketplace facilitate efficient activation of DER to respond to wholesale price signals, operate within network limits and progress to participation in wholesale dispatch over time?
 - **Summary of Hypotheses**
 - a. DER participation in wholesale market can be achieved progressively and align with ESB reforms.
 - b. System Operator and DNSP interactions can be defined and implemented efficiently to maintain DER within limits at all times.
 - c. The aggregator should be responsible for ensuring DER value stack instead of the market operator co-optimising services.

For extensive and in-depth information on the Problem statement, objectives and research plan please refer to the [Project EDGE Research Plan](#)¹ available on [AEMO website](#)².

1.2 What is a Boffer

Boffer or Bi-directional Offer is defined as an offer that can include both generation and load capacity that the aggregator is willing to offer in the market across 20 price bands or as an fixed quantity (Energy Fixed Loading – EFL). In Project EDGE a Boffer represents the whole of aggregator’s portfolio (i.e., all registered NMs in the Aggregator portfolio). Aggregator can submit a Boffer containing prices and band availabilities (i.e., price/quantity (\$/qty) Boffer) or only quantity (i.e., EFL Boffer) or a Boffer containing both \$/qty pairs as well EFL field populated.

A Boffer communicates aggregator intent to the market, provides visibility of the price responsiveness of the portfolio and an operational forecast to AEMO as the System and Market Operator.

Boffers are submitted by the Aggregator for the purposes of participation in wholesale energy market. As the trial progresses through various phases the application of the Boffer under those phases and different scenarios will also go through a progression – from being visibility only to a scheduled resource. The Boffer data schema remains relatively static as we progress through phases/scenarios.

In Project EDGE Aggregators are required to submit a Boffer every 5 minutes, the Boffer must include offer capacity for the next 48 hours (i.e., all 5-minute 576 dispatch intervals in next 48 hours) representing the whole of the aggregator portfolio.

1.3 Boffer and other functions

The Boffers described in this paper is related to the following other function sets of the Project EDGE DER Marketplace:

- **Wholesale integration**

- NMI Operating Envelopes (OE) or import/export limits at a site are applied by the Aggregator to construct their portfolio level Boffer prior to submission to the DER marketplace
- Boffers provide operational visibility and price responsive of the aggregator’s full portfolio to the market
- Boffers incorporating distribution network limits facilitate consideration of OEs in the overarching wholesale dispatch process and how OEs impact aggregator participation and dispatch.

- **Data exchange**

- To facilitate the transfer of data to monitor conformance to dispatch targets of DER fleets at scale.

- **Local Services**

¹ Project EDGE Research Plan (<https://aemo.com.au/-/media/files/initiatives/der/2022/master-research-plan-edge.pdf?la=en>)

² <https://aemo.com.au/en>

- Quantity (bandAvail or fixedLoad) offered by the Aggregator in the Boffer must consider and incorporate any capacity commitments to a DNSP for local network support services. This consideration provides a mechanism to mitigate the risk of double dispatch or conflicting dispatch signals between wholesale and local services.

2 Design principles & priorities in relation to Boffer

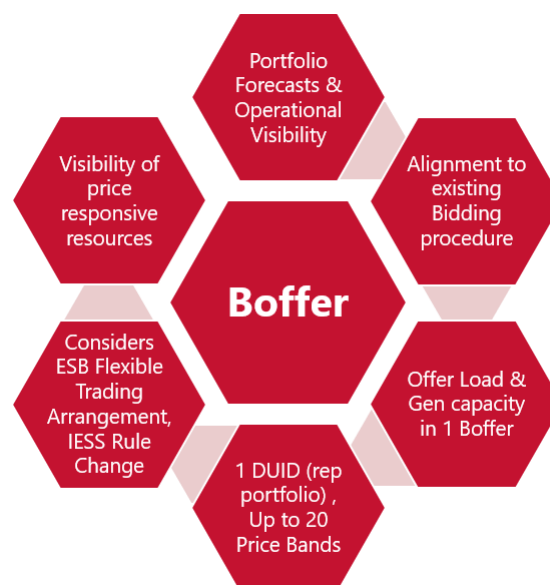

The following design principles are prioritised in determining the final design of the Boffer function.

- Appropriate visibility of material resources to manage supply demand balance and maintain an operable system as the resource mix transforms.^{3,4}
- Portfolios operational visibility and operational forecasts data requirements
- Need visibility of price responsive resources but need to avoid double counting of capacity. For example, Solar PV capacity in portfolios submitting bids must be removed from region wide rooftop PV forecasts provided the offer is for aggregated connection point flows – measured at NMI.
- Importance of alignment with Post 2025 Electricity market design thinking on future scheduling options including Flexible Trading Arrangements, Schedule Lite⁵.

³ AEMO, 2020. Power System Requirements. Available: https://www.aemo.com.au/-/media/Files/Electricity/NEM/Security_and_Reliability/Power-system-requirements.pdf.

⁴ AEMO, 2020. Renewable Integration Study. Available: <https://aemo.com.au/en/energy-systems/major-publications/renewable-integration-study-ris>.

⁵ ESB Post 2025 Electricity Market Design. Available: <https://esb-post2025-market-design.aemc.gov.au/>

- Align with the Integrated Energy Storage Solution (IESS) rule change and test participation of bi-directional unit using a single DUID to represent generation and load in a Boffer.
- Align with the existing NEM Bidding procedure thereby aiming to minimise radical changes to the current bidding process and reduced implementation costs.
- Simplicity for AEMO and for participants
- To test a progression of sophistication starting from 'Visibility' to 'self-dispatch' to 'scheduled' resource in DER Marketplace.
 - Visibility entails Aggregator providing portfolio level forecast and operational visibility of their portfolio.
 - 'Self-Dispatch' entails nominating a self-dispatch target using fixed load
 - 'Scheduled' resource wherein the Aggregator is offering load/generation quantity in different price bands.

3 Design Options analysis

There is a spectrum of options available to test on how Aggregators could participate in the wholesale dispatch process, depicted below.



Figure 1 Spectrum of approaches for Aggregator participation in wholesale dispatch

The spectrum begins in the present day where DER fleets (Aggregators) are non-scheduled, exempt from participating in wholesale energy services and wholesale dispatch and are not visible to AEMO. With increasing penetration of DER the magnitude and volume of these price responsive DER fleets could cause inefficient market operations and increased system risks.

The different approaches to wholesale participation are depicted progressively across the spectrum (left to right):

- Moving from lower to higher cost/implementation complexity approaches
- Moving from lower to higher levels of Aggregators portfolio visibility and consequential system operability as Aggregators grow in materiality

The hypothesis behind this spectrum is that it maps a pathway for Aggregators to increase their sophistication in how they participate in wholesale dispatch as they grow in size and materiality.

Moving up the spectrum should only occur if it results in sufficient net benefit – i.e. the benefits to system operability, increased sophistication of the market participants and efficient market operation outweigh the extra costs (to AEMO and Aggregators) of Aggregators increasing the sophistication in how they participate in wholesale dispatch.

Project EDGE aims to test the three approaches to Aggregator participation inside the green box. The cost benefit analysis should identify indicative timeframes for when (at what level of DER penetration) extra sophistication in how Aggregators participate in wholesale dispatch provides sufficient net benefit.

4 Proposed design

This section outlines the proposed design and the approach that’s in scope for testing in Project EDGE, together with additional detail on what will be tested and how. The field tests and research plan will progress along the Step 1, 2 and 3 outlined below.

Please refer to the Project EDGE - Data Specification Part B for detailed description of Boffer data definition and schema, business validation rules covering Boffer ingestion and market solve. Boffer data schema is designed to support Boffer progression from Step 1 to Step 3.

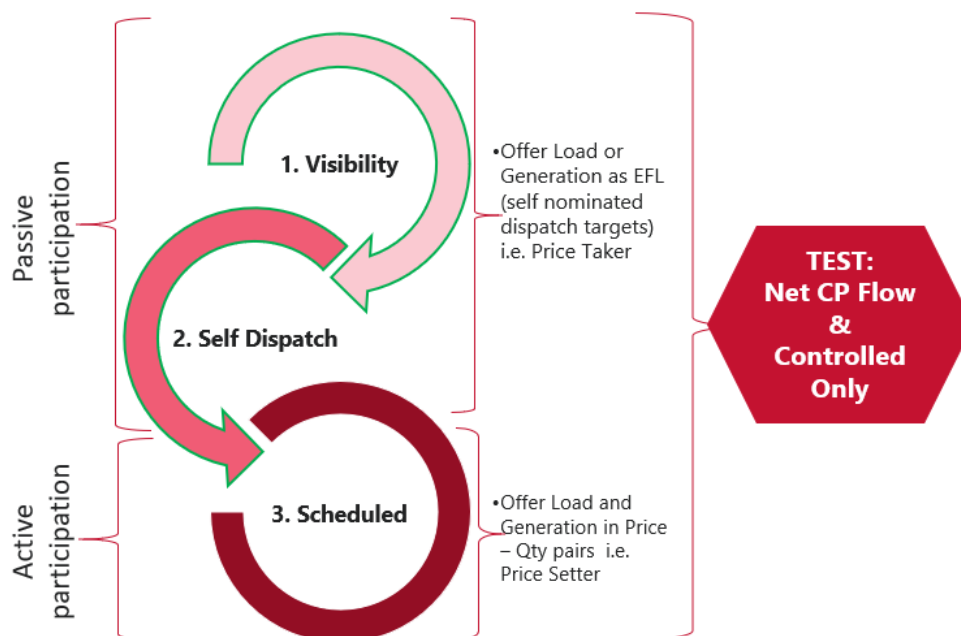

Figure 2 Boffer proposed design and progression

4.1 In Scope & Justification

Item	Item Description	Step 1: Visibility	Step 2: Self Dispatch	Step 3: Scheduled
Boffer Characteristic	Type of Boffer	Forecast Boffer: Aggregator uses price/quantity (\$/qty) Boffer to provide DUID level forecasts.	Forecast & Market Participation Boffer: Aggregator uses Energy Fixed Loading (EFL) field to: <ul style="list-style-type: none"> Provide DUID level forecast Self-nominates a dispatch target for the dispatch interval. 	Forecast & Market participation Boffer: Aggregator uses EFL field or Price/Quantity pairs to <ul style="list-style-type: none"> Provide DUID level forecast Offer quantity (load and/or generation) to deliver wholesale energy services
Boffer Purpose	What is the purpose of the Boffer	<ul style="list-style-type: none"> Provides operational visibility to AEMO No market participation Dispatch target sent by AEMO Aggregator is not required to act on or respond to the dispatch target 	<ul style="list-style-type: none"> Provides operational visibility to AEMO Passive market participation Price taker Boffer and doesn't influence clearing price calculation. Dispatch target sent by AEMO Aggregator is required to act on and respond to the dispatch target 	<ul style="list-style-type: none"> Provides operational visibility to AEMO Active market participation Price Setter Boffer. In EDGE this will not influence NEM clearing price Dispatch target sent by AEMO Aggregator is required to act on and respond to (or meet) the dispatch target.
Def. of Quantity	Where the offered quantity is measured	<ul style="list-style-type: none"> Measured at the connected point at the site; then aggregated across the portfolio. This is referred as 'Net Connection Point flow'. Indicated in Boffer via <code>bofferSummationLevel = 'NMI'</code> Measured at the common measurement point behind the meter (representing the aggregation of all controllable DER assets at a site) and then aggregated across the across the portfolio. Indicated in Boffer via <code>bofferSummationLevel = 'Flex'</code> 		
Offer Quantity Value	How load & generation is represented	<ul style="list-style-type: none"> Load quantity is offered as '-ve' value; this is the import from the grid Generation quantity is offered as '+ve' value; this is the export to the grid 		
Boffer Option	How Boffer is constructed	Quantity offered as price/quantity pairs in 20 price bands.	Quantity offered only as Energy Fixed Load (EFL)	Quantity offered as price/quantity pairs in 20 price bands or in EFL
Boffer Structure	How Boffer band availability are structured	<ul style="list-style-type: none"> Load quantity offered in Band 1 to 10 Generation quantity offered in Band 11 to 20 Aggregator can choose to offer Generation and/or Load in Boffer 		

Item	Item Description	Step 1: Visibility	Step 2: Self Dispatch	Step 3: Scheduled
Boffer Submission/ Re-bid	Frequency of submission of Boffer/Re-bid	Continuous; every 5 minutes		
Boffer Granularity & Time Horizon Period	Time resolution & time period covered by Boffer	<ul style="list-style-type: none"> • 5min • 48 hours rolling time period (i.e. 48 hours ahead from time of submission) • A submission must consist of all 576 5-min intervals in the 48-hr period⁶ • Data from previous (or past) dispatch interval(s) within the trading day is not required to be submitted 		
Boffer Composition	Level at which Boffer is constructed	DUID; In EDGE DUID represents the whole of Aggregator portfolio. Thus, a Boffer as well represents whole portfolio		
Boffer Gate Closure Rule	What Gate closure rule is applicable Boffer	Aggregator price bands are firmed and locked at 12.30 PM a day before trading day ⁷ i.e. (T-1). After that time an Aggregator can only change the quantity but not the price bands.	Not applicable	Aggregator price bands are firmed and locked at 12.30 PM a day before trading day i.e. (T-1). After that time an Aggregator can only change the quantity but not the price bands.

This table should be read as follows:

- EDGE will test Aggregators participating in the wholesale dispatch process with bi-directional portfolios that can operate as both net load and net generation.
 - The Boffer will facilitate 20 price bands, with 10 price bands each to be used for generation (export) and load (import) instead of the current 10 bands (In NEM currently the 10 price bands are for either load or generation), to be consistent with the rule change for Integrated Energy Storage Systems (IESS).
 - An Aggregator will submit Boffer containing Generation and/or Load quantity
 - EDGE will explore two different definitions of the quantity (Energy) in the Boffer:
 - Sum of net connection point flows across the participant’s registered portfolio of NMIs referred in the above table as Aggregated net Connection Point flow (in Boffer referred as NMI)
 - Sum of controllable and flexible devices across the participant’s registered portfolio of NMIs referred as ‘Flex’ in the above table. This option seeks to explore how future arrangements may work in which the settlement point is moved from the connection

⁶ Only in the EDGE trial Aggregators are required to re-submit a Boffer file every 5 minutes. Under the current rules in NEM, a market participant only has to submit a NEM wholesale bid once a day at 12.30 PM before the trading day (i.e. T-1 at 12.30 for 4 AM to 4 AM). Market participant can choose to rebid as per their discretion.

⁷ In NEM a Trading Day is defined as a 24 hour period commencing 4:00 AM AEST and finishing at 4:00 AM on the following day. EDGE will adopt same Trading Day definition.

point NMI to a new child NMI behind the connection point. This is explored in the Flexible Trading Arrangements outlined in the Energy Security Board Post 2025 work.^{8, 9}

- EDGE will explore three approaches/progressive Steps for how aggregators can participate in the wholesale dispatch process.
 - These Steps progress from the simplest approach to participation “Visibility” in which the aggregator is providing operational visibility via a forecast of anticipated operation in Boffer and instantaneous 1 minute measurement and submission of aggregated DUID level telemetry of actual operation, to the most complex approach “Scheduled” in which the aggregator is operating much like a scheduled resource.
 - In each Step or progression, the Boffer represents forecast or desired operational behaviour for the next 48 hour period from time of submission.
 - Considering above two definitions of Quantity there are six scenarios for testing.

4.2 Key Concepts

4.2.1 Data Coverage:

The Boffer file submitted to AEMO is for the whole of the portfolio. In EDGE Aggregator’s DUID represents whole of Aggregator portfolio that is covering all the NMI enrolled in the EDGE trial by Aggregator).

4.2.2 Controllable (or Flexible) Assets:

Any DER asset that can be remotely and actively controlled – turned on, turned off, ramped-up or ramped-down is categorised as a controllable asset. In EDGE this capacity is referred to as the ‘FLEX’ definition of quantity (kW/kWh). Some examples of controllable or flexible assets are

- Batteries
- Solar PV & inverter
- Smart Hot water system
- Demand response enabled devices
- Smart Household appliances controlled using HEMS

It is clear from the above definition of controllable or flexible assets that:

⁸ <https://esb-post2025-market-design.aemc.gov.au/32572/1619564199-part-a-p2025-march-paper-esb-final-for-publication-30-april-2021.pdf> page 69.

⁹ <https://esb-post2025-market-design.aemc.gov.au/32572/1619564172-part-b-p2025-march-paper-appendices-esb-final-for-publication-30-april-2021.pdf>.

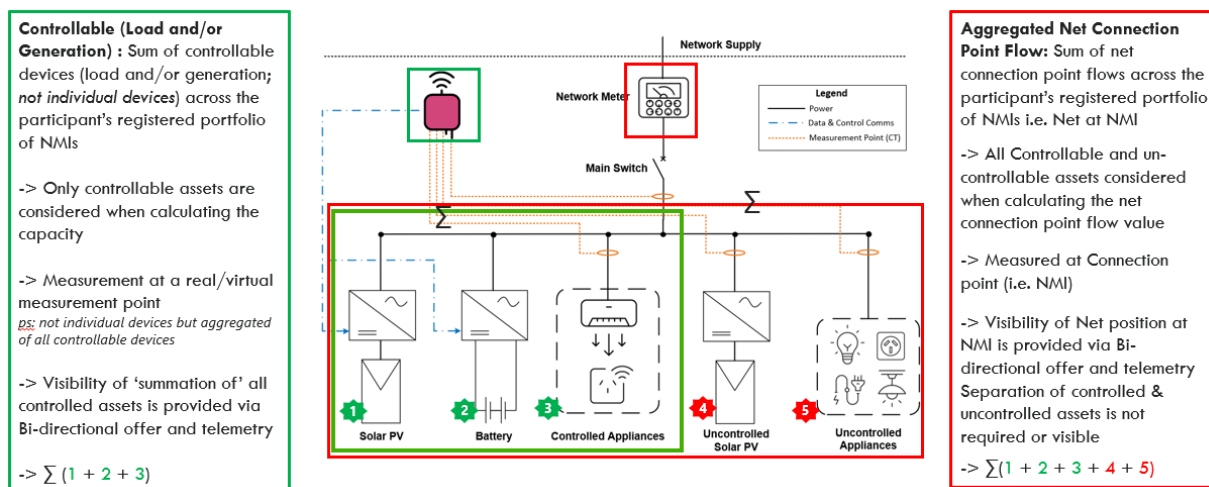

Figure 3 Sample site with Energy Storage System (Battery) and rooftop solar (PV)

- if the Aggregator can constrain/turn off or turn on the PV generation then the PV is Controllable.
- if the Aggregator is only controlling/flexing the ESS according to the outcomes of the PV generation, then PV is not being actively controlled. i.e when PV is generating, rather than reducing PV output the ESS is charged to compensate for additional Generation then PV is not being actively controlled, therefore does not appear in telemetry data as controlled generation. For example:
 - Uncontrolled PV Generation at sites in aggregator's fleet turns up and the ESS which is controllable compensates by charging; the ESS charge quantity would appear in the controlled load field of the Aggregated Telemetry.
 - Uncontrolled PV Generation at sites in aggregator's fleet goes down and the ESS compensates by discharging; the ESS discharge quantity would appear in the controlled generation field of the Aggregated Telemetry

4.2.3 Boffer Structure and Band Availability:

Boffer is designed and structured with total of 20 price bands with 10 bands used for each direction. First 10 bands - band 1 to 10 are earmarked for offering load quantity and bands 11 to 20 are earmarked for offering generation quantity.

Band availability refers to the capacity aggregator is willing to offer in the market in a particular price band. Load capacity is provided as '-ve' number in bands 1 to 10 only; these bands represent the demand bid of the aggregator. Generation capacity is provided as '+ve' number in bands 11 to 20 only, these bands represent the generation bid of the aggregator. An aggregator can offer capacity in load bands only, generation bands only or in both load and generation bands.

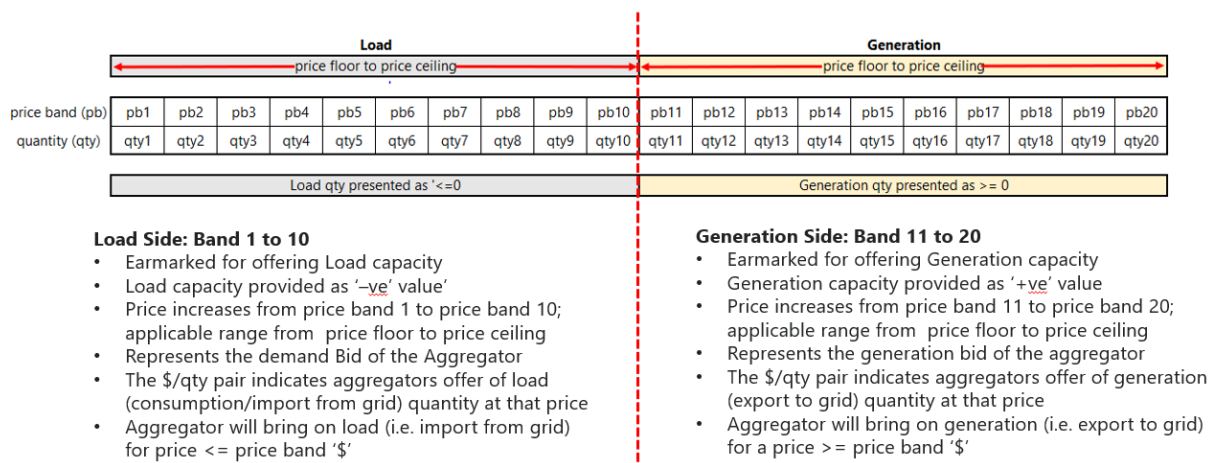

Figure 4 Boffer structure

The image below visually represents the various building blocks of the Boffer and the table below provides the description of the various components.

Please note: it is expected that aggregators will always submit Boffer with 'Accumulation Quantity'.

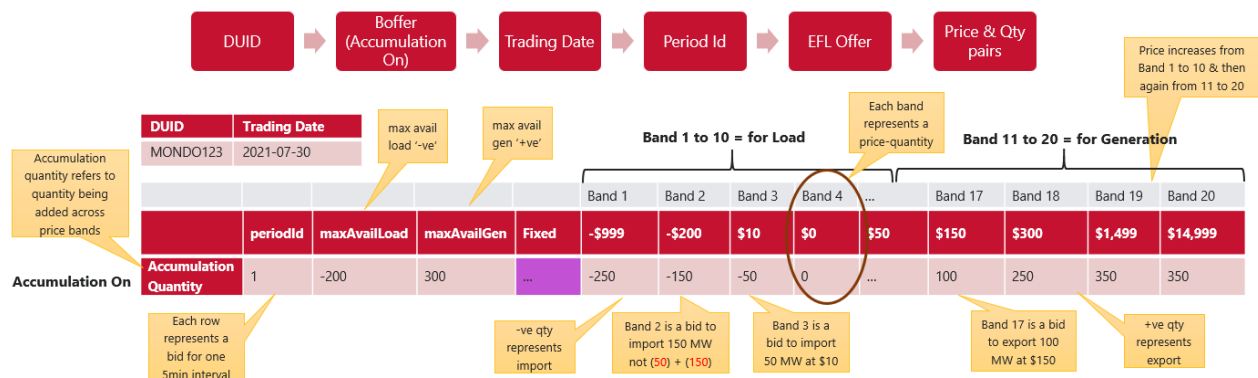

Figure 5 Sample Boffer file

Table 1 Boffer component description

Boffer Structure Component	Attribute Name	Description
DUID	duid	Logically represents the aggregator portfolio in the system
Boffer Accumulation	accumulateBands	This specifies that the band availabilities are aggregated (summed-up) to the total availability at the band.
Trading Date	tradingDate	Refers to the trading date for which Boffer is submitted
Period ID	periodId	Refers to the 5 min Dispatch Interval Id
Maximum Available Load	maxAvailLoad	maximum load availability for a dispatch interval,

Boffer Structure Component	Attribute Name	Description
Maximum Available Generation	maxAvailGen	maximum generation availability for a dispatch interval,
EFL	fixedLoad	Fixed level of load or generation offered by the Aggregator
Price Bands	pb1....pb20	Price bands across which aggregators will offer quantities either as load or as generation
Band Availability	bandAvail1...bandAvail20	Capacity or quantity the Aggregator is willing to offer in the market at a certain price
Boffer Summation Level	bofferSummationLevel	<p>This specifies the capacity points summed or definition to quantity used to calculate the Boffer.</p> <p>NMI: A Boffer that represents the aggregated net position at connection point (including native loads).</p> <p>FLEX: A Boffer that represents only the aggregated controllable portion of the portfolio (i.e. all controllable loads or all controllable generations)</p>

4.2.4 Maximum Available Load

Maximum Available Load is used by the Aggregator to 'self-limit' the maximum amount of load for which the Aggregator can be dispatched for. The table below describes Maximum Available Load definition and other characteristics.

	Maximum Available Load
Definition	Aggregator's maximum load availability for a dispatch interval, in kilowatts.
Attribute Name	maxAvailLoad
Intended Usage	This field is nominated by Aggregator; and indicates the maximum amount of Load for which the Aggregator can be dispatched for by AEMO
Interpreted As	This provides upper bound on load for the given dispatch interval
Value	maxAvailLoad is provided as -ve value
Provided By	Nominated by Aggregator
Provided In	Boffer; for each dispatch interval maxAvailLoad can have a different value
Validation	must be less than or equal to the maximum load capacity of the aggregator (in absolute value)

4.2.5 Maximum Available Generation

Maximum Available Generation is used by the Aggregator to 'self-limit' the maximum amount of generation for which the Aggregator can be dispatched for. The table below describes Maximum Available Generation definition and other characteristics.

	Maximum Available Generation
Definition	Aggregator's maximum generation availability for a dispatch interval, in kilowatts.
Attribute Name	maxAvailGen
Intended Usage	To field is nominated by Aggregator; and indicates the maximum amount of Generation for which the Aggregator can be dispatched for by AEMO
Interpreted As	This provides upper bound on generation for the given dispatch interval
Value	maxAvailGen is provided as +ve value
Provided By	Nominated by Aggregator
Provided In	Boffer; for each dispatch interval maxAvailGen can have a different value
Validation	must be less than or equal to the maximum generation capacity of the aggregator (in absolute value)

4.3 Boffer Progression Step 1: Visibility

The visibility step refers to the Aggregator providing the operational visibility and portfolio forecast data via the Boffer using the price & band availability fields. This is also referred as \$/qty Boffer. In this step the aggregator is communicating the intended future behaviour and price responsive points of the portfolio i.e. what will the aggregator do with their portfolio at different price points without needing to participate in the market or needing to respond to AEMO dispatch instructions.

This step is focused on providing visibility only to AEMO in a system and market operator role without needing to dispatch end devices. This is fully aligned with the Energy Security Board (ESB) Schedule Lite initiative which is working on establishing a framework for aggregators to 'opt in' and be incentivised for providing operational visibility to AEMO without the need to be dispatched. This is the first step towards incorporating DER information at scale into AEMO operational forecasts and the National Electricity Market.

The quantity offered shall consider

- Minimising grid imports and maximise self-consumption
- NMI level Operating Envelopes as provided by the DNSP

In this initial step AEMO will generate and send the Dispatch Instructions to the Aggregators. Aggregators are not required to act on or respond to the dispatch instructions.

Table 2 Participate in Visibility Only

'Day in the life' in relation to a trading day¹⁰

Day Before Trading Day¹¹ (T-1)

- DNSP calculates the operating envelope and sends to AEMO
- AEMO sends the operating envelope to the Aggregators
- Aggregator reviews available capacity for wholesale Bi-directional offer, taking into account:
 1. Import / export limits communicated through operating envelope (where applicable, i.e. there is an updated limit to comply with at a given NMI)
 2. Capacity required for other services (for example Local service)
- Aggregator creates and submits a price/quantity (\$/qty) Boffer for the wholesale energy spot market by 12.30 PM a day prior to start of the trading day (i.e., 12.30 PM T-1 where T is trading day).
- The Boffer submitted must cover total of 48-hour time period i.e. should have price/quantity for 576 dispatch intervals.

Trading Day Leading up to Dispatch Interval

- In Step 1, Aggregator will submit the Boffer every 5 mins; Aggregator will take into consideration actual telemetry to update the \$/qty values.
- Aggregator updates and re-submits \$/qty Boffer for the wholesale energy spot market every 5 minutes. The aggregator will endeavour to update every interval in the Boffer to reflect their updated forecast.

Trading Day (Dispatch)

- AEMO generates and sends Dispatch Instructions to the Aggregators every 5 minutes
- Aggregator is **not required** to act on or respond to the Dispatch instructions.
- Aggregator provides DUID Telemetry data after the fact to AEMO.

Post-Dispatch

- AEMO assess Aggregator forecast (as Boffers) against the DUID Telemetry data to determine forecast accuracy.

4.4 Boffer Progression Step 2: Self-dispatch

Boffer Step 2 is designed to test the hypothesis that the aggregator entry pathway to the NEM will be eased if there is a 'stepping stone' mechanism on the way to the sophistication required for bidding as a scheduled resource (20 \$/qty bands and dispatch instructions). Step 2 is intended to provide aggregators with the flexibility and control to set their own dispatch targets to test and learn with relatively small volumes of flexible resources before developing more sophisticated systems to be able to determine bids at many price points, with the confidence to meet these forecasts if dispatched to do so by AEMO.

¹⁰ AEMO, *NEM Spot Market Operations Timetable*. Available: https://www.aemo.com.au/-/media/Files/Electricity/NEM/Security_and_Reliability/Dispatch/Spot-Market-Operations-Timetable.pdf

¹¹ Trading Day runs for a 24 hour period from 0400 hours on the trading day to 0400 hours on the following day (TD+1)

‘Self-Dispatch’ refers to the Boffer progression stage where Aggregator participates in the Market by being a price taker and self-nominating their dispatch target by offering quantity in the EFL field only. AEMO will generate and send dispatch instructions to the Aggregator, and it is expected the Aggregator will respond to the Dispatch instructions.

The same Boffer used in Step 1 – Visibility are used to nominate a self-dispatch target and forecast covering 48 hrs from time of submission. No price/quantity values are required for this step. Similar to Step 1, Aggregator will continue to update and submit the Boffer every 5 minutes covering a period of 48 hrs.

If participants don’t submit a Boffer, the previous successfully accepted Boffer rolls forward automatically in an ‘effective date model’ which means AEMO always has some information to feed into the dispatch process.

The following table shows the high-level sequence of events in relation to how Aggregators will participate in the wholesale dispatch process in EDGE.

Table 3 Participate as ‘Self Dispatch’

‘Day in the life’ in relation to a trading day¹²

<p>Day Before Trading Day¹³ (T-1)</p> <ul style="list-style-type: none"> • DNSP calculates the operating envelope and sends to AEMO • AEMO sends the operating envelope to the Aggregators • Aggregator reviews available capacity for wholesale Bi-directional offer, taking into account: <ol style="list-style-type: none"> 1. Import / export limits communicated through operating envelope (where applicable, i.e. there is an updated limit to comply with at a given NMI) 2. Capacity required for other services (e.g., Local Service) 3. AEMO pre-dispatch price forecast • Aggregator creates / updates and submits EFL only Boffer for the wholesale energy. Aggregator is not required to offer capacity in price/quantity pairs in this step. The Boffer submitted must cover total of 48-hour timeperiod.
<p>Trading Day (T), Leading up to Dispatch Interval</p> <ul style="list-style-type: none"> • In this Step Aggregator reviews available capacity for wholesale Bi-directional offer, taking into account: <ol style="list-style-type: none"> 1. Import / export limits communicated through operating envelope (where applicable, i.e. there is an updated limit to comply with at a given NMI) 2. Capacity required for other services (e.g., Local service) 3. AEMO price dispatch forecast 4. Aggregator updates and re-submits Boffer for the wholesale energy every 5 minutes. The aggregator shall take reasonable effort to update every interval in the Boffer to reflect their updated forecast for the next 48 hours
<p>Trading Day (Dispatch)</p>

¹² AEMO, *NEM Spot Market Operations Timetable*. Available: https://www.aemo.com.au/-/media/Files/Electricity/NEM/Security_and_Reliability/Dispatch/Spot-Market-Operations-Timetable.pdf

¹³ Trading Day runs for a 24 hour period from 0400 hours on the trading day to 0400 hours on the following day (TD+1)

- AEMO generates and send Dispatch Instructions to the Aggregators every 5 minutes
- Aggregator performs local dispatch according to the received Dispatch Instructions
- Aggregator provides DUID Telemetry data after the fact to AEMO

Post-Dispatch

- AEMO verifies the DUID Telemetry against dispatch target to assess DER compliance
- DNSP assess compliance to the Operating envelope; and work with Aggregator to identify cause of the non-compliance
- AEMO records Aggregator compliance to Dispatch target; and work with Aggregator to identify cause of non-compliance.

4.5 Boffer Progression Step 3: Scheduled

This section outlines how Aggregators would be tested as a Scheduled resource and will be required to submit a price/quantity bi-directional offer ("Boffer"). 'Scheduled' refers to the Boffer progression stage where the Aggregator participates in the Market as a scheduled resource and a price setter. As Project EDGE is an off-market trial the Aggregator Boffers will not influence the market clearing price in NEM

In Step 3 Aggregator can choose to nominate a self-dispatch target by providing a valid value in the EFL field or provide capacity in price/quantity fields or a combination of both. If the Aggregator for a dispatch interval provides EFL as well as price quantity pair than EFL will take precedence. AEMO will generate and send dispatch instructions to the Aggregator. Aggregator is required to act on and respond to the Dispatch instructions sent. Similar to previous steps 1, Aggregator will continue to update and submit the Boffer every 5 minutes covering a period of 48 hrs.

If participants don't submit a Boffer, the previous successfully accepted Boffer rolls forward automatically in an 'effective date model' which means AEMO always has some information to feed into the dispatch process.

The following table shows the high-level sequence of events in relation to how Aggregators will participate in the wholesale dispatch process in EDGE.

Table 4 Participate as fully Scheduled

Day in the life' in relation to a trading day

Day Before Trading Day¹⁴ (T-1)

- DNSP calculates the operating envelope and sends to AEMO
- AEMO sends the operating envelope to the Aggregators
- Aggregator reviews available capacity for wholesale Bi-directional offer, taking into account:
 1. Import / export limits communicated through operating envelope (where applicable, i.e. there is an updated limit to comply with at a given NMI)
 2. Capacity required for other services (e.g., Local Service)
 3. AEMO pre-dispatch price forecast

¹⁴ Trading Day runs for a 24 hour period from 0400 hours on the trading day to 0400 hours on the following day (TD+1)

- Aggregator creates/ updates and must submit a price/quantity Boffer for the wholesale energy by 12.30pm in order to lock in the prices and meet gate closure rule.
- Aggregator can choose to offer quantity in price/quantity pairs, or fixed load value or both in this step. The Boffer submitted must cover total of 48-hour time period.

Trading Day (T), Leading up to Dispatch Interval

- In this Step Aggregator reviews available capacity for wholesale Bi-directional offer, taking into account:
 1. Import / export limits communicated through operating envelope (where applicable, i.e. there is an updated limit to comply with at a given NMI)
 2. Capacity required for other services (e.g., Local service)
 3. AEMO price dispatch forecast
- Aggregator updates and re-submits Boffer for the wholesale energy spot market every 5 minutes. The aggregator could:
 1. Update every interval in the Boffer to reflect their updated forecast for the next 48 hours
- By 12.30pm the Aggregator must submit the price/quantity Boffer for the next trading day (TD+1).

Trading Day (Dispatch)

- AEMO generates and send Dispatch Instructions to the Aggregators every 5 minutes
- Aggregator performs local dispatch according to the received DUID Dispatch Instructions
- Aggregator provides DUID Telemetry data after the fact to AEMO

Post-Dispatch

- AEMO verifies the DUID Telemetry against dispatch target to assess DER compliance
- DNSP assess compliance to the Operating envelope; and work with Aggregator to identify cause of the non-compliance
- AEMO records Aggregator compliance to Dispatch target; and work with Aggregator to investigate and resolve any case of non-compliance.

4.6 Boffer Characteristics

Given below is visual representation of a Boffer for one dispatch interval under accumulation quantity and quantity (table in grey) with call outs to reference the "Boffer characteristics" as described below. Please note ramp rates (ROC) and PASA data are out of scope for Project EDGE, and hence not shown in this image below or described in the document.

DUID		Trading Date		max avail load '-ve'	max avail gen '+ve'	Band 1 to 10 = for Load					Band 11 to 20 = for Generation				
DUID123		2021-07-30 06:55				Band 1	Band 2	Band 3	Band 4	...	Band 17	Band 18	Band 19	Band 20	
		periodId	maxAvailLoad	maxAvailGen	Fixed	-\$999	-\$200	\$10	\$0	\$50	\$150	\$300	\$1,499	\$14,999	
Accumulation On	Quantity	1	-200	300	...	-250	-150	-50	0	...	100	250	350	350	
		periodId	maxAvailLoad	maxAvailGen	Fixed	Band 1	Band 2	Band 3	Band 4	...	Band 17	Band 18	Band 19	Band 20	
Accumulation Off	Quantity	1	-200	300	...	-100	-100	-50	0	...	100	150	100	0	

Price increases from Band 1 to 10 & then again from 11 to 20

Each row represents a bid for one 5min interval

-ve qty represents import

Each band represents a price-quantity bid – e.g. Band 3 is a bid to import 50 MW at \$10. Band 17 is a bid to export 100 MW at \$150

+ve qty represents export

Figure 6 Sample Boffer – Accumulation ‘On’ and Accumulation ‘Off’

1. Negative quantity represents load or net import of aggregated connection points, positive quantity represents generation or net export.
2. A Boffer will have 20 bands: 10 representing each direction, displayed from band 1 to band 20. Band 1 to 10 are earmarked for offering Load Quantity; Band 11 to 20 are earmarked for offering Generation Quantity.
3. For a given dispatch interval prices increase from price floor to price ceiling for price band 1 to price band 10; this repeat again for price band 11 to price band 20.
4. Each band represents a price-quantity offer.
5. Maximum available generation quantity must be ≥ 0 and this will represent an upper bound on generation by aggregator portfolio.
6. Maximum available load quantity must be ≤ 0 and represents an upper bound on consumption by aggregator portfolio. Load quantity is provided as a -ve value. Note this is an additional field compared to the standard scheduled load or generation bid file.
7. Negative quantity representing load or import can only be provided in the bands 1 to 10; The \$/qty pair indicate Aggregator’s willingness to bring on load and for clearing price \leq band price; aggregator will bring on load.
8. Positive quantity representing export or generation can only be provided in the bands 11 to 20; the \$/qty pair indicate aggregator’s willingness to bring on generation for clearing price $> =$ band price; aggregator will bring on generation.
9. Once transitioned to positive (i.e. from load to generation), cannot transition back to negative, or put another way, no negative quantities can appear in higher bands than a positive quantity i.e. \$/non zero quantity must go from load to generation always. Please see below the supply chart based on the accumulation quantity Boffer.

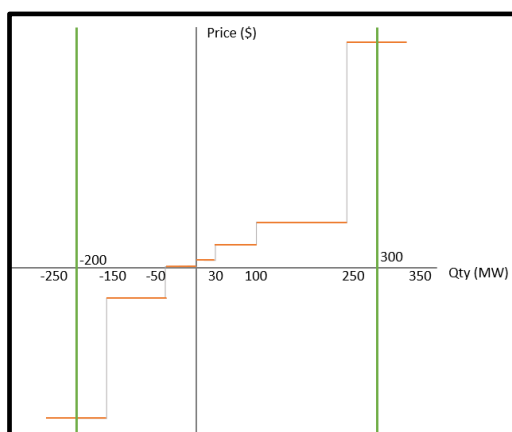

Figure 7 Sample Boffer – Supply Chart

In the above image, we can see the left-hand side green line represents maxAvailLoad, the green line on right-hand side represents maxAvailGen. The supply curve is like a staircase – always going up from load to generation.

10. Accumulation quantity display accumulates from the implied break point of zero between the bands where transition from negative quantity to positive quantity (between band 10 and band 11). Accumulates import from this point when go towards lower bands (left) and accumulates export when go towards higher bands (right).
11. Only Energy Fixed Loading or price/quantity pairs are allowed in a Boffer file, if both are provided, EFL takes precedence.
12. Energy Fixed Loading Boffer will require the aggregator to receive a dispatch instruction from AEMO or notification of acceptance of the Boffer file (received without errors).

In EDGE, the above assumes no concept of MLFs for “units” (similar to VPPs). If MLFs were to apply to these aggregator portfolios, an additional rule would apply that the prices on the bands on either side of the “zero” breakpoint would need to have price separation that ensured they continued to increase, with MLF applied.

4.7 Boffer Rules

Boffer Rule	Description	Comment
Quantity Offered	<p>Aggregator can offer quantity as “Energy Fixed Loading (EFL)” or as “Price/quantities pairs”. Offering quantity in both for a dispatch interval in the Boffer is not advised.</p> <ul style="list-style-type: none"> • If EFL and Price/Quantity pairs are provided, then EFL takes precedence over price/quantity pair. 	<ul style="list-style-type: none"> • EFL; • Price/quantity pair
Quantity	<ul style="list-style-type: none"> • Negative quantity will represent load or net import from grid. <ul style="list-style-type: none"> – Load will be offered in Band 1 to band 10 • Positive quantity will represent generation or net export to grid. <ul style="list-style-type: none"> – Generation will be offered in band 11 to band 20 	<ul style="list-style-type: none"> • Generation as +ve value

Boffer Rule	Description	Comment
	<ul style="list-style-type: none"> Once a Boffer transitions from load to generation quantity from one band to the next, then it cannot transition back to offering load quantity (i.e. a Boffer never can transition from Generation to Load (when reading from left to right)) 	<ul style="list-style-type: none"> Load as -ve value
Accumulation Quantity	<ul style="list-style-type: none"> Accumulation quantity display accumulates from the implied break point of zero between the bands where transition from negative quantity to positive quantity (band 10 to 11) Load: Accumulates import from this point (breakpoint) when go towards lower bands (left), Generation: Accumulates export from this point (breakpoint) when go towards higher bands (right). 	
Price Bands	<ul style="list-style-type: none"> A Boffer will have 20 price bands, 10 bands each way (i.e., 10 each for Load and Generation). Each band represents a price-quantity bid. For a given dispatch interval offer price must always increase across the price bands for non-zero quantity For load: band 1 will be the lowest price band and band 10 represents highest price. For generation band 11 will be the lowest price and band 20 represents highest price. Please note: EFL quantity doesn't have a price associated to it. EFL quantity represents the quantity the participant wants to be dispatched, regardless of the clearing price 	
\$/non-zero quantity	A Boffer must not have for a 'non-zero quantity' same price band value in load bands and generation bands in a single interval.	Zero qty bands can be at same price
Boffer Processing	Boffer (file) is processed in the order it is received by AEMO (most recent to oldest). If Aggregator submit multiple Boffers for a trading day, the latest successful acknowledged Boffer is used in clearing the market. It is the Aggregator's responsibility to ensure correct submission order so that the latest Boffer is the effective Boffer as acknowledged by AEMO	

4.8 Out of Scope

- Pre-dispatch, ST PASA and MT PASA data requirements
- Energy constraints
- Ramp rates

5 Linkages to NEM reforms

The Project EDGE Boffer is aligned to thinking and design of the following NEM reform initiatives. The purpose of Project EDGE as a practical field trial is to support the design and implementation of current electricity market reform with a real-world evidence base.

Links to the following project/initiative:

1. Integrating Energy Storage Systems (IESS) Rule Change¹⁵:

- a. **20 bid bands, 10 each way:** In Project EDGE we have adopted a single DUID and 20 bid band structure with 10 bid bands for load and generation as proposed by IEES Rule change for testing Wholesale Energy services. IEES takes this a step further by testing the proposed bid structure to test Ancillary services in addition to Energy,
- b. **Price validation on Boffers:** For simplicity in EDGE, we have assumed a Loss Factor of 1. If marginal Loss Factors (MLF) or Distribution Loss Factors (DLFs) are to apply, there would be a further adjustment to the price bands before Boffer validation. The validation would ensure that prices are always increasing across the price bands (pb1 to pb20), so that generation and load quantities cannot be simultaneously selected at a single energy price. For additional details please refer to the Integrating Energy Storage Systems (IESS) High level Design available at AEMO website.

2. ESB Post 2025 NEM Market Design Integration of DER and Flexible Demand

- a. **Scheduled Lite Rule Change:** Project EDGE is using Boffers as an operational forecast of aggregator portfolios (i.e. intended behaviour of the portfolio) updated/re-forecasted every 5 minutes. The Boffer progression is designed such that, it allows for the cost benefit analysis and identifying and understanding the operational challenges associated with 'visibility only' bidding to bidding as a fully scheduled resource. The data, evidence and insights from testing Boffer progressions in Project EDGE will be supporting schedule light rule change under ESB 2025 DER implementation plan. As contemplated in the Schedule Lite rule change Aggregators will be incentivised to participate (opt-in) and provide visibility (forecast) data to AEMO. Project EDGE is aligned to the thinking as the first step of Boffer progression involves aggregators providing forecast via Boffer.

¹⁵ IEES Rule Change and High-Level Design Document: <https://aemo.com.au/initiatives/submissions/integrating-energy-storage-systems-iess-into-the-nem>

b. Flexible Trading Arrangements for Distributed Energy Resources Rule Change¹⁶:

Project EDGE is aligned to Flexible Trading Arrangements (FTA) rule change as it is testing the ability for retailers and non-retailer aggregators to provide energy services using behind the meter flexible resources (DER). EDGE is taking two approaches to portfolio configuration,

- i. 1) Net at a site (everything bundled together at a site – controllable, uncontrollable and native). This is consistent with EDGE’s ‘Net NMI’ Boffer described in this document.
- ii. Aggregation of all flexible (fully controllable) assets at a site, consistent with ‘Flex’ Boffers described in this document and the Private Metering Arrangement contemplated in the FTA rule change.

This approach in EDGE allows the unbundling of behind the meter assets, consumption and generation into controlled (flexible) and uncontrolled quantities in the bidding, dispatch instructions and telemetry data. To facilitate this, Mondo will be using their own DER management and control device (the ‘Ubi’) to orchestrate response and capture device data in near real time for later service verification. This is conceptually similar to a private metering arrangement (PMA) as proposed in Flexible Trader Model 2 within the rule change. Other aggregators participating in the trial will adopt the same approach to common measurement points at their own customer sites and will be integrating with end devices directly via API integration or through a gateway device.

¹⁶ Flexible Trading Arrangements for Distributed Energy Resources Rule Change Proposal: <https://www.aemc.gov.au/rule-changes/flexible-trading-arrangements-distributed-energy-resources>

APPENDIX A. RELEVANT READING

Description	Location/Link
AEMO Website - EDGE	https://aemo.com.au/en/initiatives/major-programs/nem-distributed-energy-resources-der-program/der-demonstrations/project-edge
Project EDGE – Research Plan	https://aemo.com.au/-/media/files/initiatives/der/2022/master-research-plan-edge.pdf?la=en
Project EDGE Technical Specification	https://aemo.com.au/initiatives/major-programs/nem-distributed-energy-resources-der-program/der-demonstrations/project-edge/project-edge-technical-specifications
Project EDGE – Expression of Interest	https://aemo.com.au/-/media/files/initiatives/der/2021/edge-expression-of-interest-form.pdf?la=en
Project EDGE – Aggregator Onboarding Overview	https://aemo.com.au/-/media/files/initiatives/der/2021/der-micf-aggregator-onboarding-presentation.pdf?la=en
Project EDGE – Aggregator Overview	https://aemo.com.au/-/media/files/initiatives/der/2021/edge-aggregator-overview.pdf?la=en

APPENDIX B. GLOSSARY

Terminology	Description
Boffer	Bi-directional Offer
DUID	Dispatchable Unit Identifier
Trading Date	This refers to the date for which aggregator is offering quantity into market. A NEM trading day consists of the 24-hour period from 0400 hrs to 0400 hrs the following day.
Accumulation Band	<p>The field specifying whether or not the band availability (i.e., quantity offered) are presented as incremental availability or not.</p> <ul style="list-style-type: none"> • Accumulation Quantity = Y i.e., band availabilities are aggregated (summed-up) to the total availability at the band • Accumulation Band = N i.e., Band availabilities are not summed up rather presented as incremental availability
Period ID	Period ID refers to the 5 min Dispatch Interval Id
Energy Fixed Load (EFL)	This refers to the fixed level (quantity) of generation or load offered into Market by Aggregator, if used.
Price Band	<p>The 20 price bands (10 each way) across which aggregators will offer quantities.</p> <ul style="list-style-type: none"> • Band 1 to Band 10 are earmarked for Load (import) • Band 11 to 20 are earmarked for Generation (export)
Band Availability	Band availability refers to the quantity (volume) Aggregator is willing to offer in the market at a certain price.
maxAvailGen	Aggregator's maximum generation availability for a dispatch interval (+ve)
maxAvailLoad	Aggregator's maximum load availability for a dispatch interval (-ve)
Price & Quantity Pair	<p>Each of the \$/qty pair informs what the aggregator is willing:</p> <ul style="list-style-type: none"> • to generate 'x' kW if paid at least \$ 'y' • to consume (load) 'x' kW if will pay at most \$ 'y'
Price Taker	When an Aggregator offers their quantity as Energy Fixed Load (EFL). By offering their portfolio as "EFL Boffer"; aggregator is nominating a self-dispatch target. And informing AEMO that they would be price taker.
Price Setter	When an Aggregator offers their quantity in Price & Quantity pairs – and looking to influence the Spot Price; or only adjust load/generation depending on the price. Project EDGE is on off market trial; thus, the Boffer submitted by the Aggregators will not have an influence on the Spot Price in NEM
Quantity Offered	<p>This is the quantity (i.e., portfolio capacity) offered by the Aggregator into the market.</p> <ul style="list-style-type: none"> • Generation quantity is represented by "+ve" value in band availability (for band 11 to 20) or in EFL • Load quantity is represented by "-ve" value in band availability (for band 1 to 10) or in EFL

Terminology	Description
Controllable Devices	All end devices (either load or generation) that could be controlled i.e., instructed to follow a command (turn off/turn on/ramp up or ramp down)

APPENDIX C. SCHEDULED LOADS - CURRENT BID STRUCTURE

Bid structure	Scheduled Loads	Comment for EDGE
Energy Bands	Each price band associates an aggregated quantity of electricity consumption at the loads local connection points with a price for the scheduling of that quantity of electricity. The price represents the market clearing price at or below which the scheduled load will increase electricity consumed by up to the MW increment specified in that price band	Update for bi-directional (load and generation), 20 Bands (Band 1 to 10 for Load Quantity and Band 11 to 20 for Generation Quantity)
Energy Availability (Max Avail)	The bid maximum electrical consumption by a scheduled load that can be scheduled for the specified dispatch or trading interval	In EDGE both a MAX generation availability and a MAX Load availability are required.
Energy ramp rates	The bid maximum rates (in MW/min) at which the electrical consumption by a scheduled load can be scheduled to increase (called the Ramp Up Rate) or decrease (called the Ramp Down Rate) over the specified dispatch or trading interval	Not in scope for EDGE
Energy Fixed Loading	The bid fixed level of electricity consumption by a scheduled load (in MW) to be scheduled for the specified dispatch or trading interval	This enables aggregators to nominate a fixed level of load/generation that it wants to commit to during that interval and it just becomes a price taker. This is used in Boffer progression Step 2: Self Dispatch
Fast Start Inflexibility (On-line Dispatch only)		Not in scope for EDGE
Daily Energy Constraint (Pre-dispatch only)	The bid maximum energy consumption by a scheduled load (in MW) that can be scheduled over the specified trading day	Not in scope for EDGE
SCADA metered energy consumption	<p>Clause 3.8.2(d) of the Rules requires: adequate communication and/or telemetry is available to support the issuing of dispatch instructions and the audit of responses</p> <p>The currently metered value of consumption of the scheduled load is required by the On-line Dispatch process in order to determine the dispatch target consumption at the end of each dispatch interval and to allow AEMO to verify conformance of the scheduled load to its dispatch target.</p> <p>A means of transmitting dispatch instructions to the scheduled load is also required.</p>	In EDGE real time telemetry is provided at a DUID level through the data exchange hub.

Bid structure	Scheduled Loads	Comment for EDGE
Normally-on versus Normally-off status	The classification by AEMO of whether a scheduled load is either normally-on or normally-off is based on whether the metered consumption of that load has been historically included as a component of the metered demand calculation for the associated region. If the metered consumption of the load has been included (as that load is typically consuming power), then this load is defined to be normally-on - otherwise it is normally-off	In EDGE the default setting should be normally on.

APPENDIX D. EXISTING BID AND OFFER EXAMPLE

Appendix D provides a high level summary view of the current Offer file, Bid file and Boffer. And highlights how the Bid and Offers with bi-directional units comes together in a Boffer.

D.1 Generation Offer

Given below is a screen grab of a current Generation Offer made by a generator in NEM. The 1st image shows the Offer without accumulation quantity. The 2nd image shows the same offer but with accumulated quantity as we move across price bands.

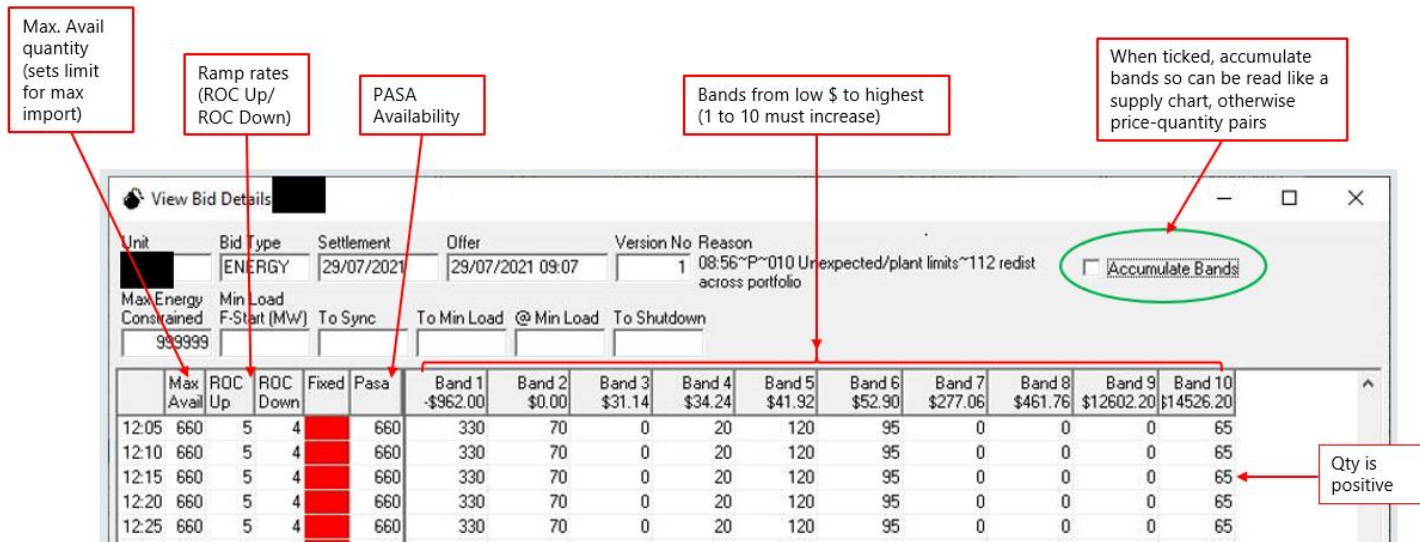

Annotations:

- Max. Avail quantity (sets limit for max import)
- Ramp rates (ROC Up/ ROC Down)
- PASA Availability
- Bands from low \$ to highest (1 to 10 must increase)
- When ticked, accumulate bands so can be read like a supply chart, otherwise price-quantity pairs
- Qty is positive

Unit	Bid Type	Settlement	Offer	Version No	Reason									
	ENERGY	29/07/2021	29/07/2021 09:07	1	08:56~P~010 Unexpected/plant limits~112 redist across portfolio									
Max Energy Constrained	Min Load F-Start (MW)	To Sync	To Min Load	@ Min Load	To Shutdown									
99999														
Max Avail	ROC Up	ROC Down	Fixed	Pasa	Band 1	Band 2	Band 3	Band 4	Band 5	Band 6	Band 7	Band 8	Band 9	Band 10
12:05	660	5	4	660	330	70	0	20	120	95	0	0	0	65
12:10	660	5	4	660	330	70	0	20	120	95	0	0	0	65
12:15	660	5	4	660	330	70	0	20	120	95	0	0	0	65
12:20	660	5	4	660	330	70	0	20	120	95	0	0	0	65
12:25	660	5	4	660	330	70	0	20	120	95	0	0	0	65

View Bid Details

Unit	Bid Type	Settlement	Offer	Version No	Reason
	ENERGY	29/07/2021	29/07/2021 09:07	1	08:56~P~010 Unexpected/plant limits~112 redist across portfolio

Accumulate Bands

Max Energy Constrained	Min Load F-Start (MW)	To Sync	To Min Load	@ Min Load	To Shutdown
999999					

	Max Avail	ROC Up	ROC Down	Fixed	Pasa	Band 1	Band 2	Band 3	Band 4	Band 5	Band 6	Band 7	Band 8	Band 9	Band 10
12:05	660	5	4	660	660	330	400	400	420	540	635	635	635	635	700
12:10	660	5	4	660	660	330	400	400	420	540	635	635	635	635	700
12:15	660	5	4	660	660	330	400	400	420	540	635	635	635	635	700
12:20	660	5	4	660	660	330	400	400	420	540	635	635	635	635	700
12:25	660	5	4	660	660	330	400	400	420	540	635	635	635	635	700
12:30	660	5	4	660	660	330	400	400	420	540	635	635	635	635	700

Comparing the quantity offered at 12:05 from the above example we can see the difference between quantity and accumulation quantity and can use the quantity to plot the supply chart. The supply chart graphically represents what the unit will be doing (generation or load) depending on the price. Price quantity pairs are directly translated into the supply chart

				pb1	pb2	pb3	pb4	pb5	pb6	pb7	pb8	pb9	pb10
	Period Id	Max Avail	Fixed Load	(\$962)	\$0	\$31.14	\$34.24	\$41.92	\$52.9	\$277.06	\$461.76	\$12,602.2	\$14,526.2
Quantity	1	660		330	70	0	20	120	95	0	0	0	65
Accum. Quantity	1	660		330	400	400	420	540	635	635	635	635	700

Given below is the supply chart based on the quantity above.

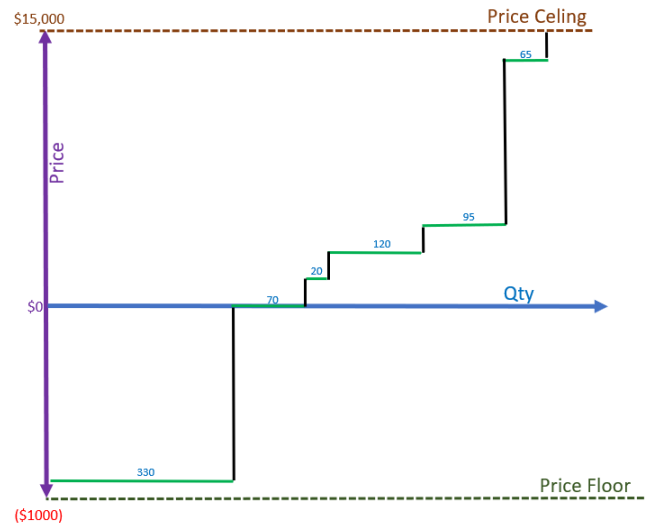

D.2 Load Bid

Given below is a screen grab of a current load Bid made by an Load in NEM. The first image shows the Offer without accumulation quantity. The second image shows the same Bid but with accumulated quantity as we move across price bands.

View Bid Details [Redacted]

Unit: [Redacted] Bid Type: ENERGY Settlement: 21/01/2022 Offer: 21/01/2022 11:24 Version No: 1 Reason: 11:20:04 A NSW 5MIN ACTUAL Price \$10.03 HIGHER THAN 5MIN PD 11:2

Accumulate Bands

Max Energy Constrained: [Redacted] Min Load F-Start (MW): [Redacted] To Sync: [Redacted] To Min Load: [Redacted] @ Min Load: [Redacted] To Shutdown: [Redacted]

	Max Avail	ROC Up	ROC Down	Fixed	Pasa	Band 10 \$285.75	Band 9 \$85.72	Band 8 \$71.44	Band 7 \$52.39	Band 6 \$38.10	Band 5 \$33.34	Band 4 \$28.58	Band 3 \$19.05	Band 2 \$0.00	Band 1 -\$952.50
04:05	0	20	100	[Red]	600	600	0	0	0	0	0	0	0	0	600
04:10	0	20	100	[Red]	600	600	0	0	0	0	0	0	0	0	600
04:15	0	20	100	[Red]	600	600	0	0	0	0	0	0	0	0	600
04:20	0	20	100	[Red]	600	600	0	0	0	0	0	0	0	0	600
04:25	0	20	100	[Red]	600	600	0	0	0	0	0	0	0	0	600

View Bid Details [Redacted]

Unit: [Redacted] Bid Type: ENERGY Settlement: 21/01/2022 Offer: 21/01/2022 11:24 Version No: 1 Reason: 11:20:04 A NSW 5MIN ACTUAL Price \$10.03 HIGHER THAN 5MIN PD 11:2

Accumulate Bands

Max Energy Constrained: [Redacted] Min Load F-Start (MW): [Redacted] To Sync: [Redacted] To Min Load: [Redacted] @ Min Load: [Redacted] To Shutdown: [Redacted]

	Max Avail	ROC Up	ROC Down	Fixed	Pasa	Band 10 \$285.75	Band 9 \$85.72	Band 8 \$71.44	Band 7 \$52.39	Band 6 \$38.10	Band 5 \$33.34	Band 4 \$28.58	Band 3 \$19.05	Band 2 \$0.00	Band 1 -\$952.50
04:05	0	20	100	[Red]	600	600	600	600	600	600	600	600	600	600	1200
04:10	0	20	100	[Red]	600	600	600	600	600	600	600	600	600	600	1200
04:15	0	20	100	[Red]	600	600	600	600	600	600	600	600	600	600	1200
04:20	0	20	100	[Red]	600	600	600	600	600	600	600	600	600	600	1200
04:25	0	20	100	[Red]	600	600	600	600	600	600	600	600	600	600	1200

Comparing the quantity offered at 04:05 from the above example we can see the difference between quantity and accumulation quantity and can use the quantity to plot the supply chart. The supply chart graphically represents what the unit will be doing (generation or load) depending on the price. Price quantity pairs are directly translated into the supply chart

				pb10	pb9	pb8	pb7	pb6	pb5	pb4	pb3	pb2	pb1
	Period Id	Max Avail	Fixed Load	\$285.75	\$85.72	\$71.44	\$52.39	\$38.10	\$33.34	\$28.58	\$19.05	\$0	(\$952.5)
Quantity	1	0		600	0	0	0	0	0	0	0	0	600
Accum. Quantity	1	0		600	600	600	600	600	600	600	600	600	1200

Given below is the supply chart based on the quantity above.

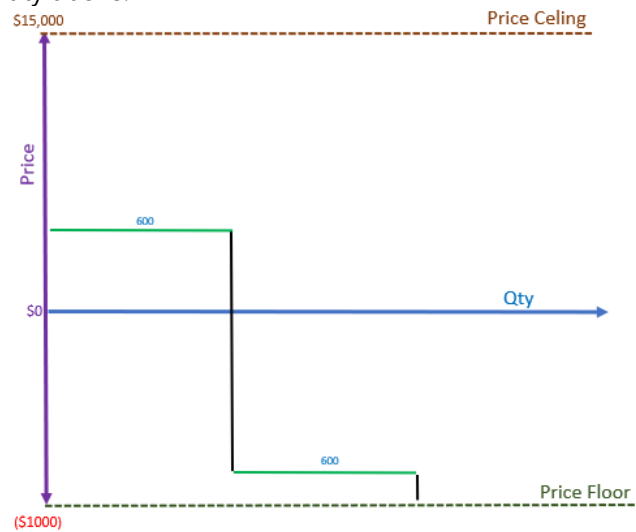

D.3 Bi-directional Offer (Boffer)

Taking examples of a Boffer and using quantity offered for 1 dispatch interval as below we can see that Aggregator

- Maximum Available load = -60 kW
- Maximum Available generation = 80 kW

And for

- \$1 or below aggregator is willing to offer -60 kW
- \$1.1 or higher aggregator is willing to offer 10 kW
- \$1,500 or higher aggregator is willing to offer additional 70 kW

Note: all generation quantity is positive and load quantity are -ve

					pb1	Pb2	Pb3	Pb4	Pb9	pb10	pb11	pb12	pb13	pb14	pb19	Pb20
	periodId	maxAvailLoad	maxAvailGen	fixedLoad	(\$1,000)	0	\$1	\$78		\$1,500	\$15,100	(\$1,000)	0	\$1.1	\$78		\$1,500	\$15,100
Quantity	1	-60	80	0			-60						10		70	
Accum. Quantity	1	-60	80	0	-60	-60	-60	0	0	0	0	0	10	10	80	80

In the above Boffer examples you can see the difference between quantity and accumulation quantity and can use the quantity to plot the supply chart. The supply chart graphically represents what the unit will be doing (generation or load) depending on the price. Price quantity pairs are directly translated into the supply chart

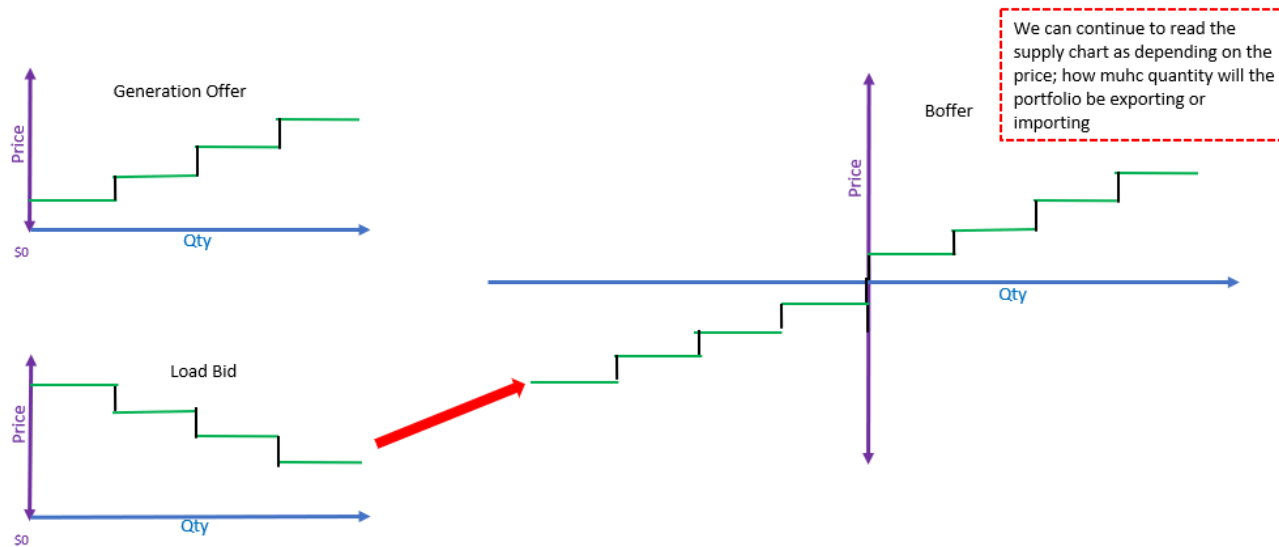
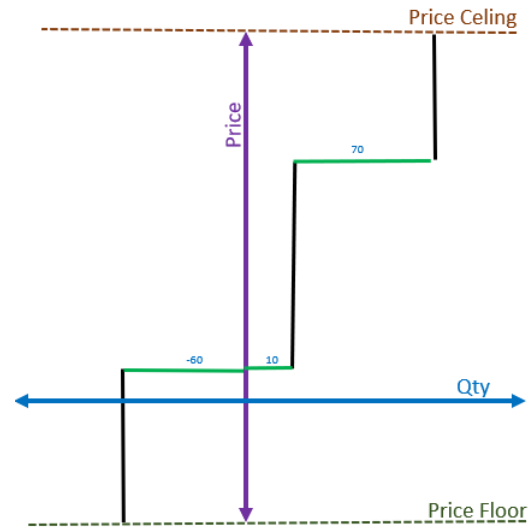

APPENDIX E. LOAD BOFFERS

This section contains Load Boffer examples. This starts with providing overview of the aggregator portfolio and then step through the Load Boffer under two scenarios

1. NMI: When quantity is measured at the NMI (or net connection point flow) - includes controlled and uncontrolled assets
2. FLEX: When quantity is measured at a common aggregation point for all controllable DER devices – includes only controllable assets

E.1 Portfolio Configuration

A portfolio consisting of 5 sites having a mix of controlled (i.e flexible) and uncontrolled (i.e. inflexible) assets as depicted below is used to illustrate the Boffer examples. This section describes the portfolio configuration including the capacity of all types of controllable assets at each site. Controlled appliances (load) represent the aggregation of all controllable load assets at the site. Uncontrolled load represents native load at the individual site.

Using the same portfolio, Section E.2.1 describes the Boffer under the NMI arrangement and Section E.2.2 describes the Boffers under the Flex arrangement. In these Boffer examples only traditional loads are considered; and any generation assets or storage (bi-directional) assets are not included in quantity offered. The Boffer examples are presented as binary usage of assets meaning absolutely turning off or turning on the asset. This is to demonstrate the flexibility in response is achieved by orchestrating the controllable assets within the portfolio.

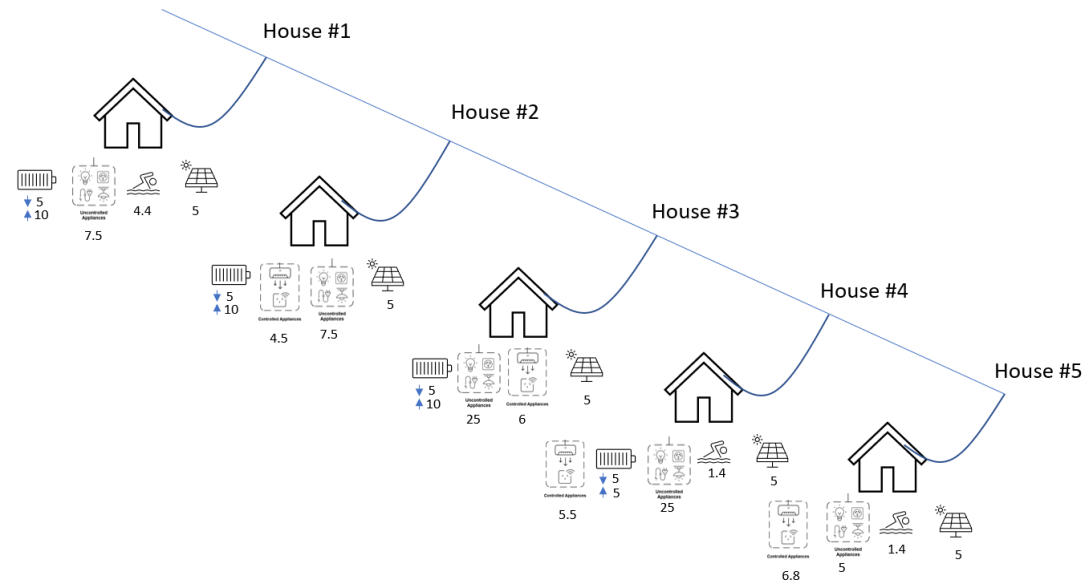

1: Portfolio Configuration Load Example

Table 5 DER Asset Capacity – Load Buffer example

The following table below describes the portfolio configuration and lists the capacity of various type of DER assets installed at each site in the above portfolio. Controlled Appliances provide the aggregation of all ‘non-DER’ controlled devices. Some examples of such devices are smart air conditioner, smart refrigerator or any demand response enabled device. Pool pump is excluded from controlled appliances. Uncontrolled appliances represent the total native load at the site.

Asset Type	House #1	House #2	House #3	House #4	House #5	Portfolio
ESS – Charge (import capability)	5	5	5	5	0	20

Asset Type	House #1	House #2	House #3	House #4	House #5	Portfolio
ESS – Discharge (export capability)	10	10	10	5	0	35
Uncontrolled Appliance	7.5	7.5	25	25	5	70
Pool Pump	4.4	0	0	1.4	1.4	7.2
Solar PV	5	5	5	5	5	25
Controlled Appliance	0	4.5	6	5.5	6.8	22.8

Unit of measure for load/generation assets= kW

E.2 Load Assets: 100 kW load with 30 kw controllable load

For simplicity and to demonstrate effect of turning off or turning on of assets from the above portfolio following example only considers traditional loads and does not take into consideration any generation assets or bi-directional assets such Battery.

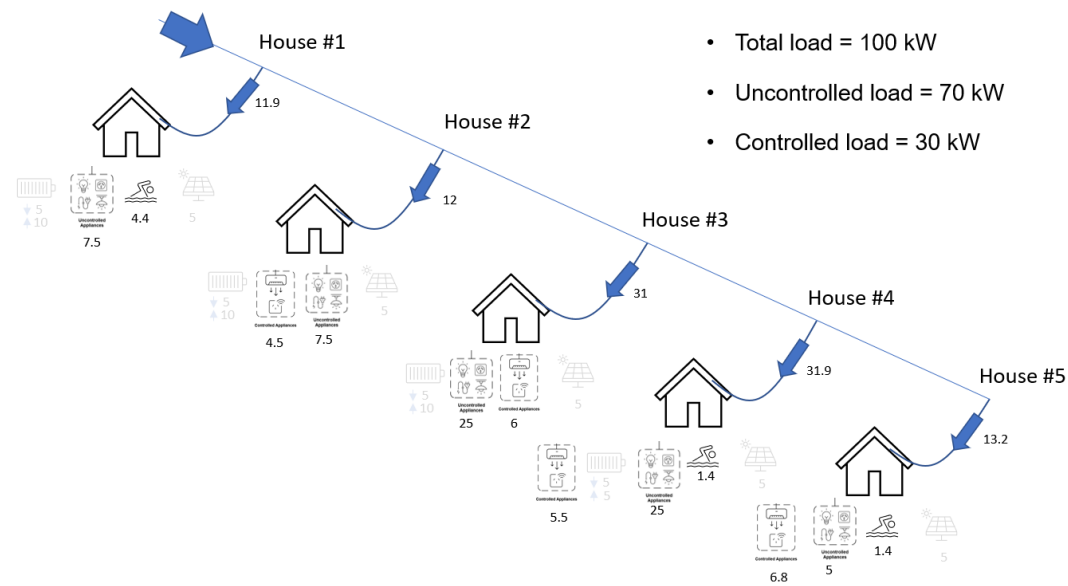

- Total load = 100 kW
- Uncontrolled load = 70 kW
- Controlled load = 30 kW

Asset Type	House #1	House #2	House #3	House #4	House #5	Portfolio
Uncontrolled Appliance	7.5	7.5	25	25	5	
Pool Pump	4.4	0	0	1.4	1.4	
Controlled Appliance	0	4.5	6	5.5	6.8	
Controlled Load	4.4	4.5	6	5.5+1.4	6.8+1.4	30
Un-controlled Load	7.5	7.5	25	25	5	70

Asset Type	House #1	House #2	House #3	House #4	House #5	Portfolio
Total Load	11.9	12	31	31.9	13.2	100

E.2.1 Load Boffer Example – NMI

Following Boffer example is based on the 'NMI' arrangement i.e. net connection point flow arrangement. The Boffer illustrates Aggregator's intent to keep the uncontrolled (or native) load of '-70 kW' always on (i.e. serviced from the grid). And offer additional -30 kW of flexible load as a price responsive load.

We can see from the Boffer provided below that Aggregator is

- Offering -70 kW load at price ceiling. This is the uncontrolled or native load within the Aggregator portfolio
- Bring an additional -30 kW of load if the price goes \$1 or below
- Turn off all controllable load if the price goes above \$1
 - Controllable load quantity is not offered at price greater than \$1.
 - '-70' quantity of uncontrolled load is offered in load bands where price is > \$1.
- As the portfolio is only offering Load, no quantity is offered in the generation price bands (i.e. pb11 to pb20)
- 0 in Accumulation quantity represents 'no flow' at the portfolio level. This means for a price band if band avail is 0 that means the aggregator is neither generating nor consuming from the grid and maintaining a net zero position.

					Pb1	Pb2	Pb3	Pb4	...	Pb9	Pb10	Pb11	Pb12	Pb13	Pb14	...	Pb19	Pb20
	Period Id	Max Avail Load	Max Avail Gen	Fixed Load	(\$1,000)	0	\$1	\$78		\$1,500	\$15,100	(\$1,000)	0	\$1	\$78		\$1,500	\$15,100
Quantity	1	-100	0	0			-30		...		-70					...		
Accum. Quantity	1	-100	0	0	-100	-100	-100	-70	...	-70	-70	0	0	0	0	...	0	0

From above Buffer:

- If the clearing price is -\$999 then cleared quantity is '-100 kW'

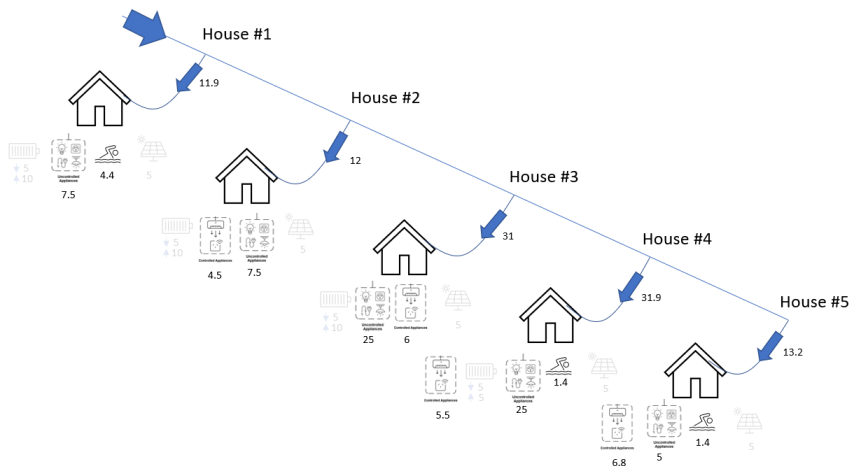

- If the clearing price is \$99 then Aggregator will switch off all flexible load (-30kW) and will only have -70 kW (native load) on; thus
 - Turn off all flexible load if price goes above \$1
 - Bring on flexible load if price goes below \$1

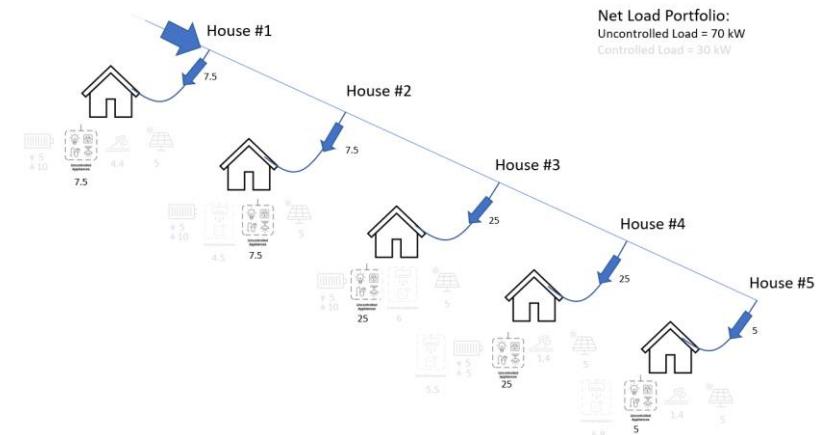



E.2.2 Impact of change in native Load

Under a NMI arrangement where measurements are done at the NMI or connection point any change in the native load or uncontrolled load at the site will have an impact on the quantity Aggregator can offer into market via Boffer. This example shows the impact of the change either increase in customer demand or decrease in customer demand (or native load) on the portfolio and Boffer. At the portfolio level as shown below there is a total increase of 6 kW of load; resulting from an increased in native demand in House #1, #2 and #5 and a reduction in native demand in house #3 and #4.

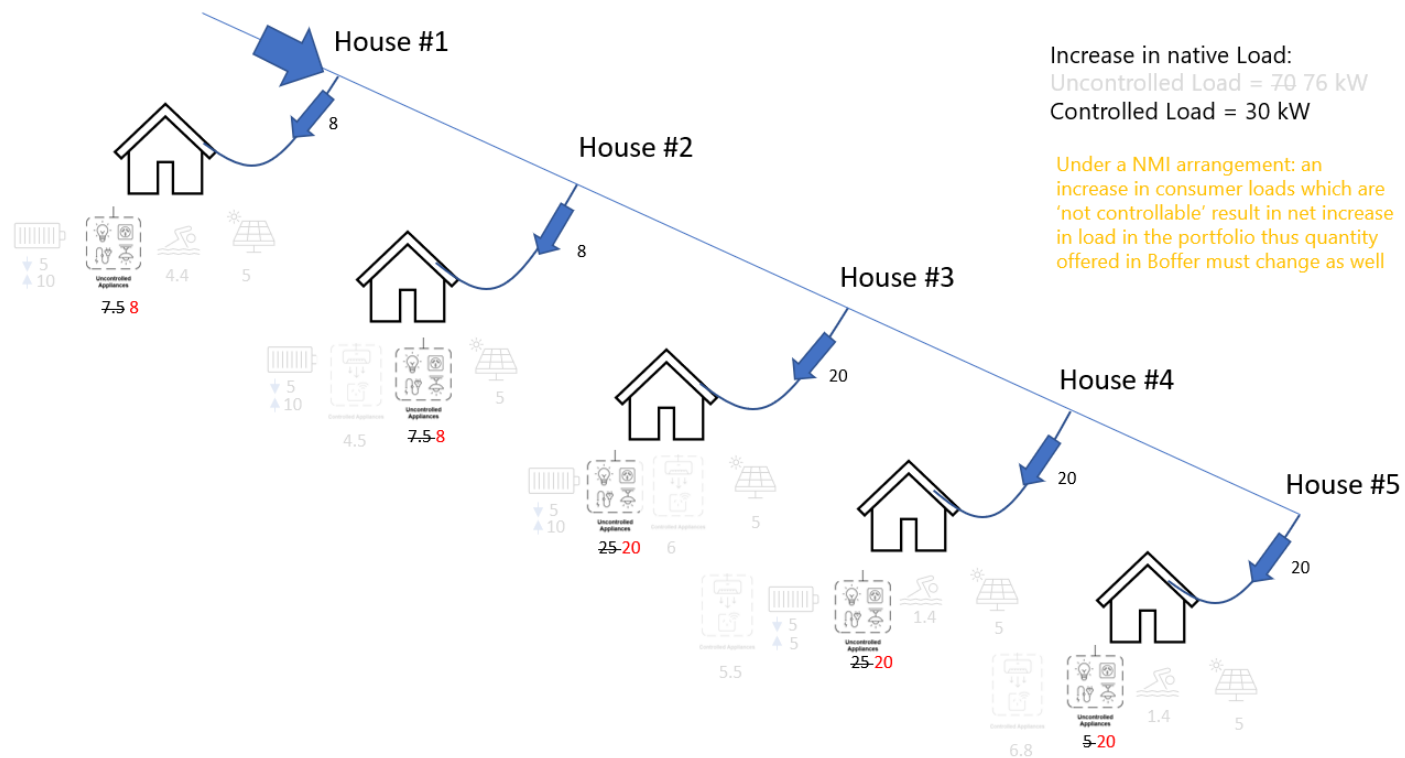

Asset Type	House #1	House #2	House #3	House #4	House #5	Portfolio
Uncontrolled Appliance	7.5 8	7.5 8	25 20	25 20	5 20	
Pool Pump	4.4	0	0	1.4	1.4	
Controlled Appliance	0	4.5	6	5.5	6.8	
Controlled Load	4.4	4.5	6	5.5+1.4	6.8+1.4	30
Un-controlled Load	8	8	20	20	20	76
Total Load	12.4	12.5	26	26.9	28.2	106

Note: The strikeout figures refer to the initial native demand prior to any increase in customer load.

Under the NMI arrangement, any change or forecasted change in the net position of the site resulting from increase or decrease in demand must be reflected in the Boffer. As presented in the above portfolio configuration table if the Aggregator is forecasting a change in the customer load, then Boffer must reflect the same change. This is shown in the Boffer example below.

At times the Aggregator might use behind the meter assets to service this increase in the customer load in order to meet the previous Boffer/forecast then the self-consumption must be reflected in the telemetry data provided.

					Pb1	Pb2	Pb3	Pb4	...	Pb9	Pb10	Pb11	Pb12	Pb13	Pb14	Pb19	Pb20
	Period Id	Max Avail Load	Max Avail Gen	Fixed Load	(\$1,000)	0	\$1	\$78		\$1,500	\$15,100	(\$1,000)	0	\$1	\$78		\$1,500	\$15,100
Quantity	1	-106	0	0			-30			-76						

					Pb1	Pb2	Pb3	Pb4	...	Pb9	Pb10	Pb11	Pb12	Pb13	Pb14	...	Pb19	Pb20
Accum. Quantity	1	-106	0	0	-106	-106	-106	-76	...	-76	-76	0	0	0	0	...	0	0

E.2.3 Load Boffer Example – FLEX

Following Boffer example is based on the 'FLEX' arrangement i.e aggregation of controllable load and generation assets in the portfolio. Under the FLEX arrangement in this example Aggregator can only Offer controllable load. The Boffer illustrates Aggregator's intent to offer -30 kW of flexible load as a price responsive load.

We can see from the Boffer below that Aggregator is

- offering to bring -30 kW of load for price \$1 or below
- not offering any laod quantity if the price goes above \$1
 - If the price goes above \$1 then Aggregator will turn off all controllable load.
 - This is represented in Boffer via the '0' quantity in bands where price is > \$1.
- As the portfolio is offering Load only, no quantity is offered in the generation price bands (i.e. pb11 to pb20)
- 0 in Accumulation quantity represents 'no flow' at the portfolio level. This means for a price band if band avail is 0 that means the aggregator is neither generating nor consuming from the grid i.e. maintaining a net zero position.

					pb1	Pb2	Pb3	Pb4	Pb9	pb10	pb11	pb12	pb13	pb14	pb19	Pb20
	periodId	maxAvailLoad	maxAvailGen	fixedLoad	(\$1,000)	0	\$1	\$78		\$1,500	\$15,100	(\$1,000)	0	\$1	\$78		\$1,500	\$15,100
Quantity	1	-30	0	0			-30			
Accum. Quantity	1	-30	0	0	-30	-30	-30	0	0	0	0	0	0	0	0	0

E.2.4 Impact of change in native Load

Under the FLEX arrangement any change in uncontrolled load or consumer load will have no impact or change on the Boffer quantity. As under a Flex arrangement Aggregator is only offering controlled load. Any change in the forecast native or consumer load doesn't have an impact on the controlled load quantity offered in the FLEX Boffer. If the Aggregator wishes to maximise the self-consumption; this must be reflected in the quantity offered under flex arrangement in Boffer. Under FLEX arrangement Boffer quantity only represents flexible or controllable portion of the portfolio.

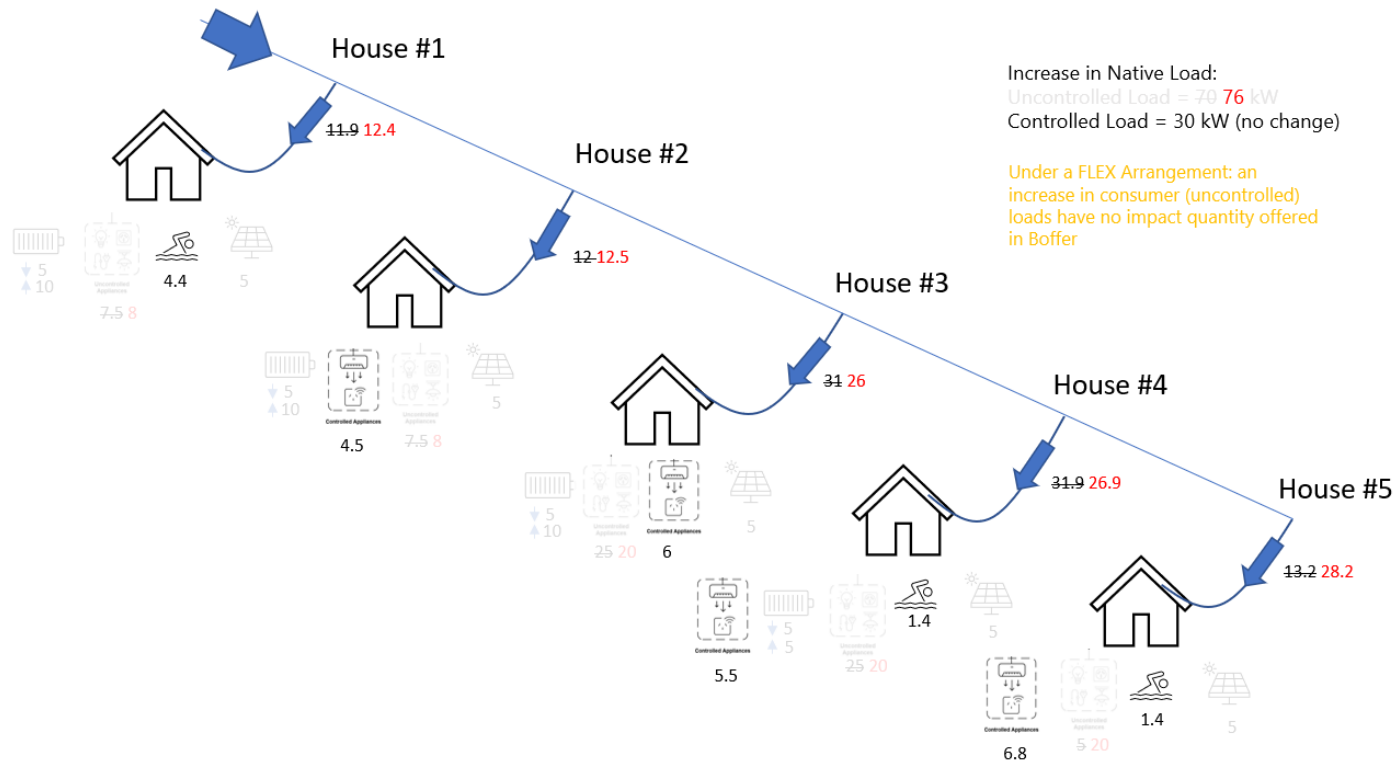

APPENDIX F. GENERATION BOFFERS

F.1 Portfolio Configuration

A portfolio consisting of 5 sites having a mix of controlled (i.e flexible) and uncontrolled (i.e. inflexible) assets as depicted below is used to illustrate the Boffer examples. This section describes the portfolio configuration including the capacity of all types of controllable assets at each site. Controlled appliances (load) represent the aggregation of all controllable load assets at the site. Uncontrolled load represents native load at the individual site.

Using the same portfolio, Section E.2.1 describes the Boffer under the NMI arrangement and Section E.2.2 describes the Boffers under the Flex arrangement. In these Boffer examples controllable loads are not considered. All generation assets including storage (bi-directional) assets are included in quantity offered. The Boffer examples are presented as binary usage of assets meaning absolutely turning off or turning on the asset. This is to demonstrate the flexibility in response is achieved by orchestrating the controllable assets within the portfolio.

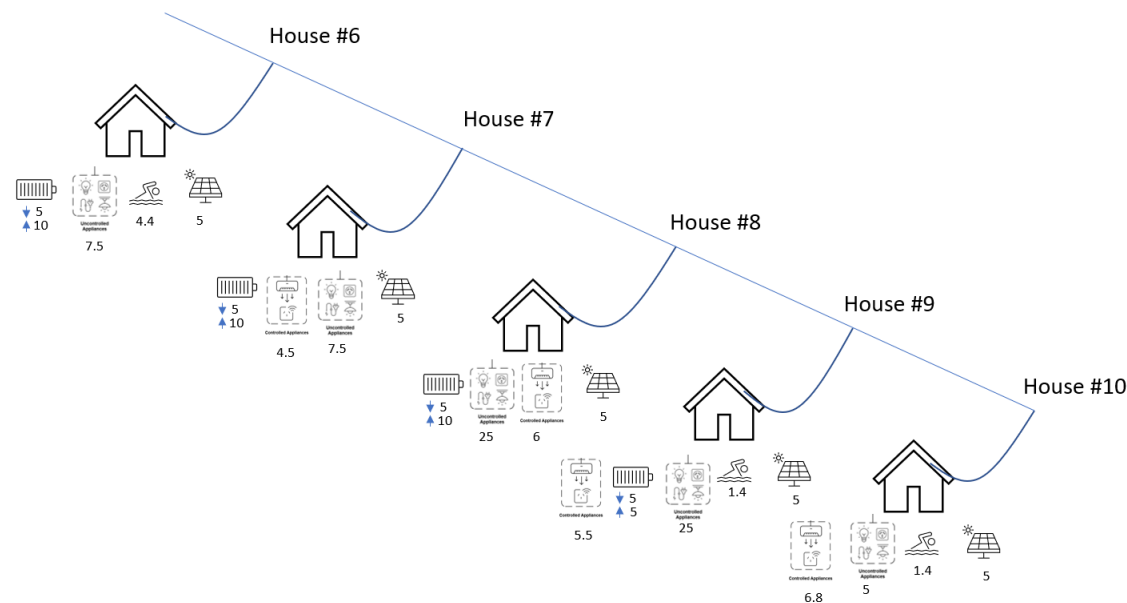

Table 6 DER Asset Capacity

The following table below describes the portfolio configuration and lists the capacity of various type of DER assets installed at each site. Please note Controlled Appliances provide the aggregation of all non-DER controlled devices at the site and uncontrolled appliances provide the total native load at the site.

Portfolio	House #6	House #7	House #8	House #9	House #10	Portfolio
ESS – Charge	5	5	5	5	0	20
ESS - Discharge	10	10	10	5	0	35
Uncontrolled Appliance	7.5	7.5	25	25	5	70
Pool Pump	4.4	0	0	1.4	1.4	7.2
Solar PV	5	5	5	5	5	25
Controlled Appliance	0	4.5	6	5.5	6.8	22.8

F.2 Generation: 60 kW flexible Generation with 70 kW native load

For simplicity and to demonstrate effect of turning off or turning on of assets from the above portfolio following example only considers controllable generation assets and native load. These examples exclude controllable.

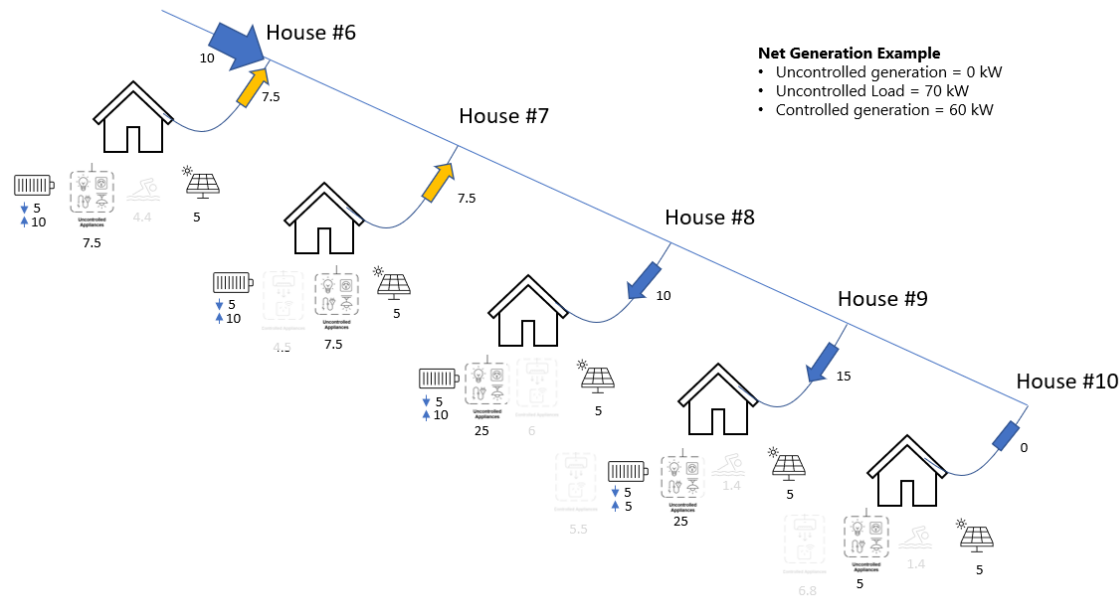

In this example

- House #6 & House #7 are exporting (generating) 7.5 kW each [total generation 10+5, total load is 7.5]
- House #8 is consuming -10 kW [total generation 10+5, total load is 25]
- House #9 is consuming -15 kW and [total generation 5+5, total load is 25]
- House #10 has no active power flow (i.e. 0). [total generation 5, total load is 5]

Thus as a whole portfolio we can see at the aggregate level the portfolio is consuming -10 kW from the grid. This example excludes the controlled loads as part of the portfolio. Based on the generation available the portfolio is still a net load. Even after fully utilising the controllable generation assets in the portfolio, Aggregator is still a load.

Asset Type	House #1	House #2	House #3	House #4	House #5	Portfolio
ESS - Discharge	10	10	10	5	0	
Uncontrolled Appliance	7.5	7.5	25	25	5	
Solar PV	5	5	5	5	5	
Controlled Generation	10 + 5	10 + 5	10 + 5	5 + 5	5	60
Un-controlled Generation	0	0	0	0	0	0
Un-controlled Load	7.5	7.5	25	25	5	70
Total Generation	15	15	15	10	5	60

F.2.1 Generation Buffer Example- NMI

Following Buffer examples is based on the 'NMI' arrangement i.e net connection point flow arrangement. The following Buffer illustrates Aggregator's intent to keep the uncontrolled (or native) load of '-70 kW' always on (i.e. serviced from the grid) at the floor price.

As illustrated in the Buffer below Aggregator is

- Offering -10 kW at price ceiling. This is the base load or always on load within the Aggregator portfolio which cannot be met by generation within the portfolio (i.e. not self-served).
- At \$1 or below, aggregator will turn off all generation in the portfolio (i.e. stop self-consumption), resulting in what looks to be an increase of -60 kW load. This load was previously served by generation within the portfolio. Please note this is not additional load but previously self-served load that now will be served from grid.

- The aggregator minimises grid imports (or maximises self-consumption) if the price goes above \$1
- At above \$1, aggregator will keep all controlled generation switch on (at portfolio level – 60 kW generation is on which meets the -70kW of load resulting in -10kW of net load)
- The aggregator maximises grid imports (or minimises self-consumption) if the price is at or below \$1
- No quantity offered in the generation price bands (pb11 to pb20)

					pb1	Pb2	Pb3	Pb4	...	Pb9	pb10	pb11	pb12	pb13	pb14	pb19	Pb20
	Period Id	Max Avail Load	Max Avail Gen	Fixed Load	(\$1,000)	0	\$1	\$78		\$1,500	\$15,100	(\$1,000)	0	\$1	\$78		\$1,500	\$15,100
Quantity	1	-70	0	0			-60			-10						
Accum. Quantity	1	-70	0	0	-70	-70	-70	-10	-10	-10	0	0	0	0	0	0

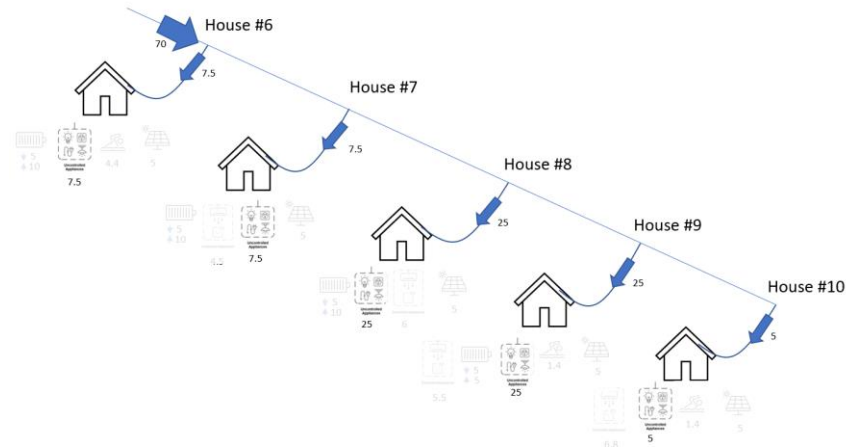

F.2.2 Generation Boffer Example- FLEX

Following Boffer examples is based on the 'FLEX' arrangement i.e aggregation of controllable load and generation assets in the portfolio. Under the FLEX arrangement Aggregator is only offering controllable generation assets into the market. The following Boffer illustrates Aggregator's intent to offer 60 kW of controllable generation as a price responsive generation.

- At \$1 or above, aggregator will bring on 60 kW of generation
- Stop generating below \$1
- 0 represents no flow at the portfolio level (no generation or no consumption)

					Pb1	Pb2	Pb3	Pb4	...	Pb9	Pb10	Pb11	Pb12	Pb13	Pb14	...	Pb19	Pb20
	Period Id	Max Avail Load	Max Avail Gen	Fixed Load	(\$1,000)	0	\$1	\$78		\$1,500	\$15,100	(\$1,000)	0	\$1	\$78		\$1,500	\$15,100
Quantity	1	0	60	0									60			
Accum. Quantity	1	0	60	0	0	0	0	0	0	0	0	0	60	60	60	60

Contrasting the two examples above, under the NMI arrangement (in E 2.1) the Aggregator is offering to pay price ceiling (~ \$15,100) for keeping on the -10 kW of native load. Whereas under the FLEX arrangement (in E 2.2) using only the controllable generation assets the Aggregator can be paid up to price ceiling for keeping on 60 kW of generation

APPENDIX G. BI-DIRECTIONAL PORTFOLIO

G.1 Portfolio Configuration:

A portfolio consisting of 5 sites having a mix of controlled (i.e flexible) and uncontrolled (in flexible) assets as depicted below is used to illustrate 'bi-directional' portfolio. This section describes the portfolio configuration including the capacity of all controllable or flexible and uncontrollable or inflexible assets at each site. Controlled appliances (load) represent the aggregation of all controllable assets at the site. Uncontrolled load represents native load at the individual site.

Using the same portfolio, Section F.2.1 describes the Boffer under the NMI arrangement and Section F.2.2 describes the Boffers under the Flex arrangement. In these Boffer examples all controllable and non-controllable assets are considered. All generation assets including storage (bi-directional) assets are included in quantity offered. The Boffer examples are presented as binary usage of assets meaning absolutely turning off or turning on the asset. This is to demonstrate the flexibility in response is achieved by orchestrating the controllable assets within the portfolio.

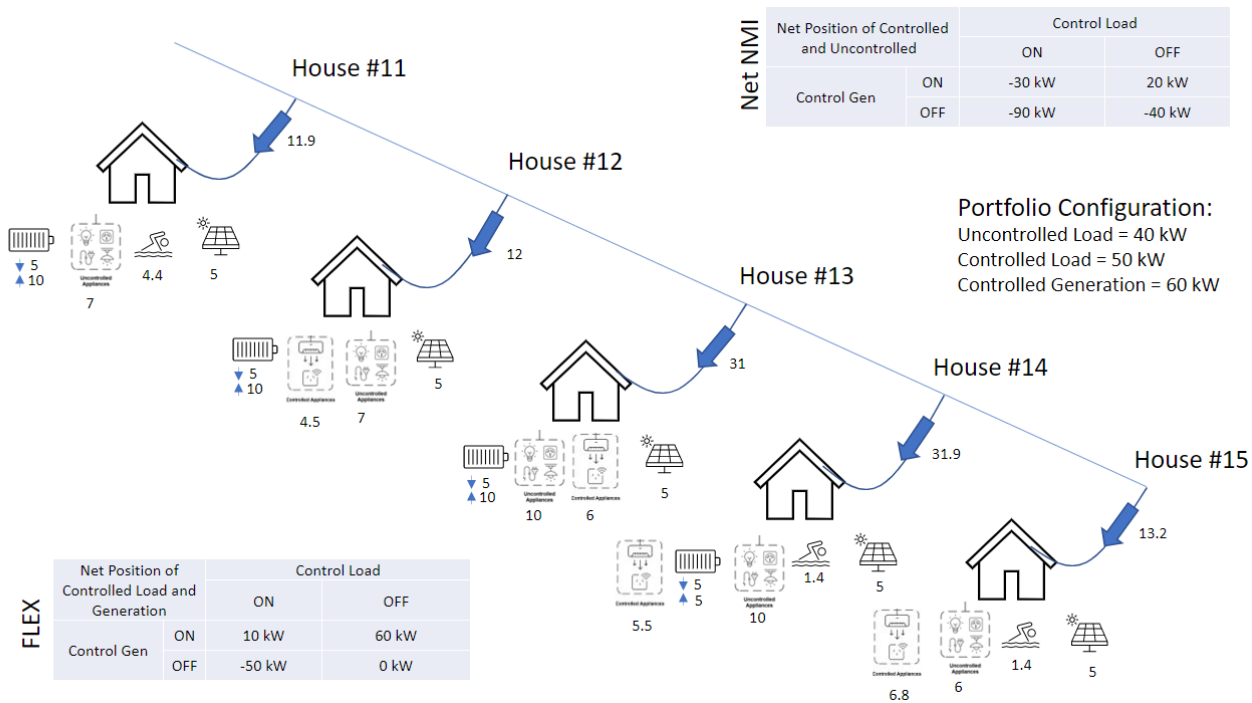

Table 7 DER Asset Capacity

The following table below describes the portfolio configuration and lists the capacity of various type of DER assets installed at each site. Please note Controlled Appliances provide the aggregation of all non-DER controlled devices at the site and uncontrolled appliances provide the total native load at the site.

Portfolio	House #11	House #12	House #13	House #14	House #15	Portfolio
ESS – Charge	5	5	5	5	0	20
ESS - Discharge	10	10	10	5	0	35

Portfolio	House #11	House #12	House #13	House #14	House #15	Portfolio
Uncontrolled Appliance	7	7	10	10	6	40
Pool Pump	4.4	0	0	1.4	1.4	10.2
Solar PV	5	5	5	5	5	25
Controlled Appliance	0	4.5	6	5.5	6.8	22.8

G.2 Bi-directional: 60 kW flexible generation, 50 kW controllable Load and 40kW base load

Portfolio	House #11	House #12	House #13	House #14	House #15	Portfolio
ESS – Charge	5	5	5	5	0	
ESS - Discharge	10	10	10	5	0	
Uncontrolled Appliance	7	7	10	10	6	
Pool Pump	4.4	0	0	1.4	1.4	
Solar PV	5	5	5	5	5	
Controlled Appliance	0	4.5	6	5.5	6.8	
Un-controlled Load	7	7	10	10	6	40
Controlled Load	5 + 4.4	5 + 4.5	5 + 6	5 + 1.4 + 5.5	5 + 1.4 + 6.8	50
Controlled Generation	10 + 5	10 + 5	10 + 5	5 + 5	5	60

G.2.1 Bi-directional Boffer Example - NMI

Following Boffer example is based on the 'NMI' arrangement i.e net connection point flow arrangement. The Boffer illustrates Aggregator's intent to offer a price responsive capacity (-90 kW of load and 60 kW of generation)



					pb1	Pb2	Pb3	Pb4		Pb9	pb10	pb11	pb12	pb13	...	pb18	pb19	Pb20
	Period Id	Max Avail Load	Max Avail Gen	Fixed Load	(\$1,000)	0	\$1	\$78		\$100	\$15,100	(\$1,000)	0	\$1	...	\$101	\$1,500	\$15,100
Quantity	1	-90	20	0		-50	-10		-30					.	50		
Accum. Quantity	1	-90	20	0	-90	-90	-40	-30	-30	0	0	0	0	..	20	20	20

- -90 kW (40 kW uncontrolled load and 50 kW of controlled load) load offered at price floor; this refers to the maximum load that can be offered by the Aggregator. At this price band Aggregator is offering to bring on all load and constrain all generation
- 20 kW of controlled generation offered at price ceiling; this is the maximum generation that can be offered by the Aggregator.

G.2.2 Bi-directional Boffer Example - FLEX

Following Boffer example is based on the 'FLEX' arrangement i.e aggregation of controllable load and generation assets in the portfolio. The Boffer illustrates Aggregator's intent to offer maximum of -50 kW of flexible load and maximum of 60 kW of flexible generation.

As illustrated in the Boffer below Aggregator

- In pb2 At \$0 or below is offering -50 kW of load
- Not offering load or generation quantity between price band pb4 and pb13 (both inclusive) i.e. if the price goes above 0 Aggregator will turn of the flexible load and will maintain a net zero position
- In pb18 at \$100 or above offering 10 kW of generation i.e. keeping flexible load and flexible generation on.
- In pb19 at price \$1,500 or above offering additional 50kW flexible generation. Above this price aggregator will turn off all flexible load and will only keep the flexible generation on

0 represents no flow at the portfolio level (no generation or no consumption)

					pb1	Pb2	Pb3	Pb4		Pb9	pb10	pb11	pb12	pb13	...	pb18	pb19	Pb20
	Period Id	Max Avail Load	Max Avail Gen	Fixed Load	(\$1,000)	0	\$1	\$78		\$1,500	\$15,100	(\$1,000)	0	\$1	...	\$100	\$1,500	\$15,100
Quantity	1	-50	60	0		-50	0		10	50	
Accum. Quantity	1	-50	60	0	-50	-50	0	0	0	0	0	0	0	..	10	60	60

Controlled Load On
Generation Off

Controlled Load Off
Generation Off

Controlled Load On
Generation On

Controlled Load Off
Generation On

APPENDIX H. DUID TELEMETRY DATA MEASUREMENTS

DUID Telemetry data consists of the aggregated instantaneous period ending measurement of active power flow at NMI or connection point at a site; and actual generation, actual load and actual energy stored for controllable (of flexible) assets in the portfolio.

Refer to DUID Telemetry Data Overview available at [AEMO Project EDGE](#) for additional details and data requirements. Taking example of the portfolio as described in Appendix D; below image shows the difference in DUID telemetry measurements under NMI and Flex arrangements.

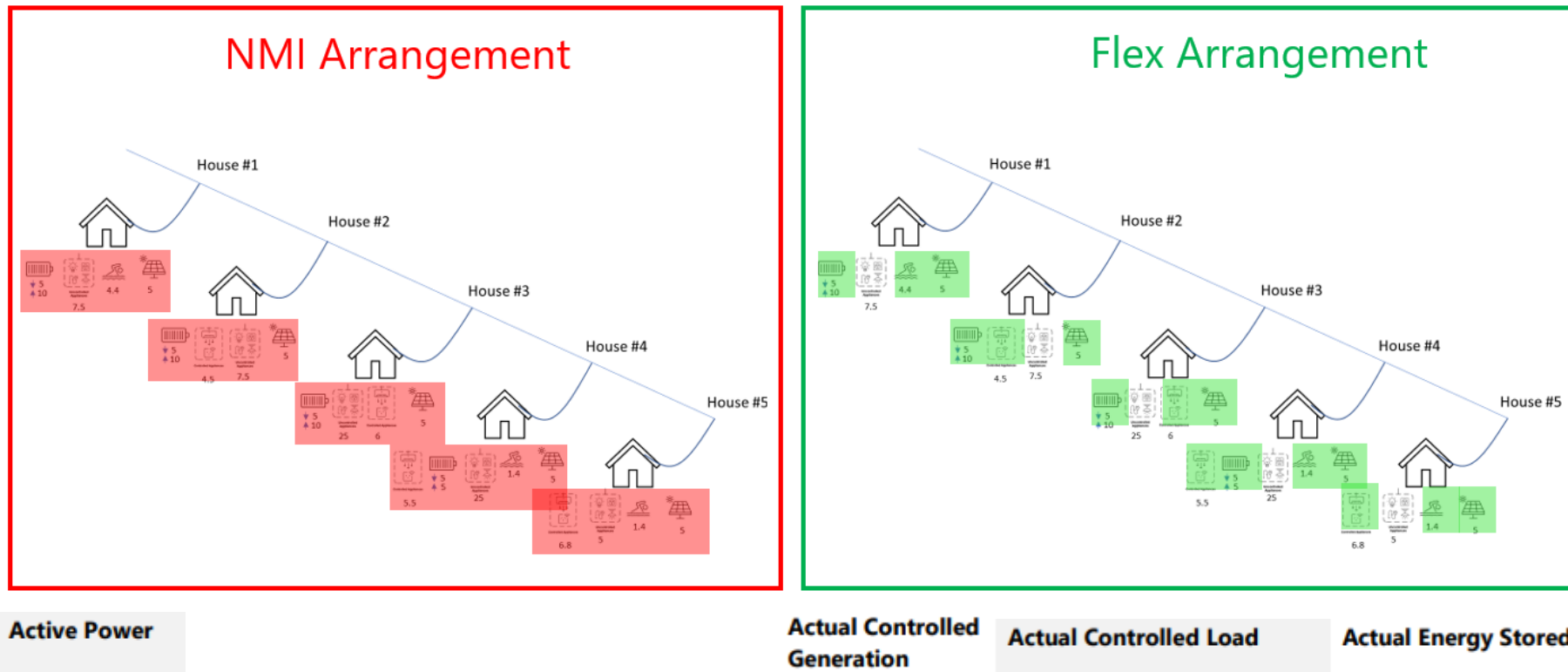

Under the NMI Arrangement (i.e. net connection point flow) DUID telemetry measurements are done at the NMI; all controllable (or flexible) and uncontrollable load and generation assets are considered when calculating the net flow at NMI. Then this is aggregated across the registered portfolio of NMIs.

- Active Power at DUID is always measured at NMI

Under the Flex Arrangement DUID Telemetry measurements are done at a common aggregation (or measurement) point for all flexible assets; only controllable (or flexible) load and generation assets are considered when calculating the net flow at the common measurement point. Then this is aggregated across the registered portfolio of NMIs.

- Controlled Generation, Controlled load and Energy storage are measurements of flexible assets only.

The following sections describes the difference in the DUID telemetry measurements between the NMI arrangement and FLEX arrangement

H.1 DUID Telemetry: Net Load Portfolio

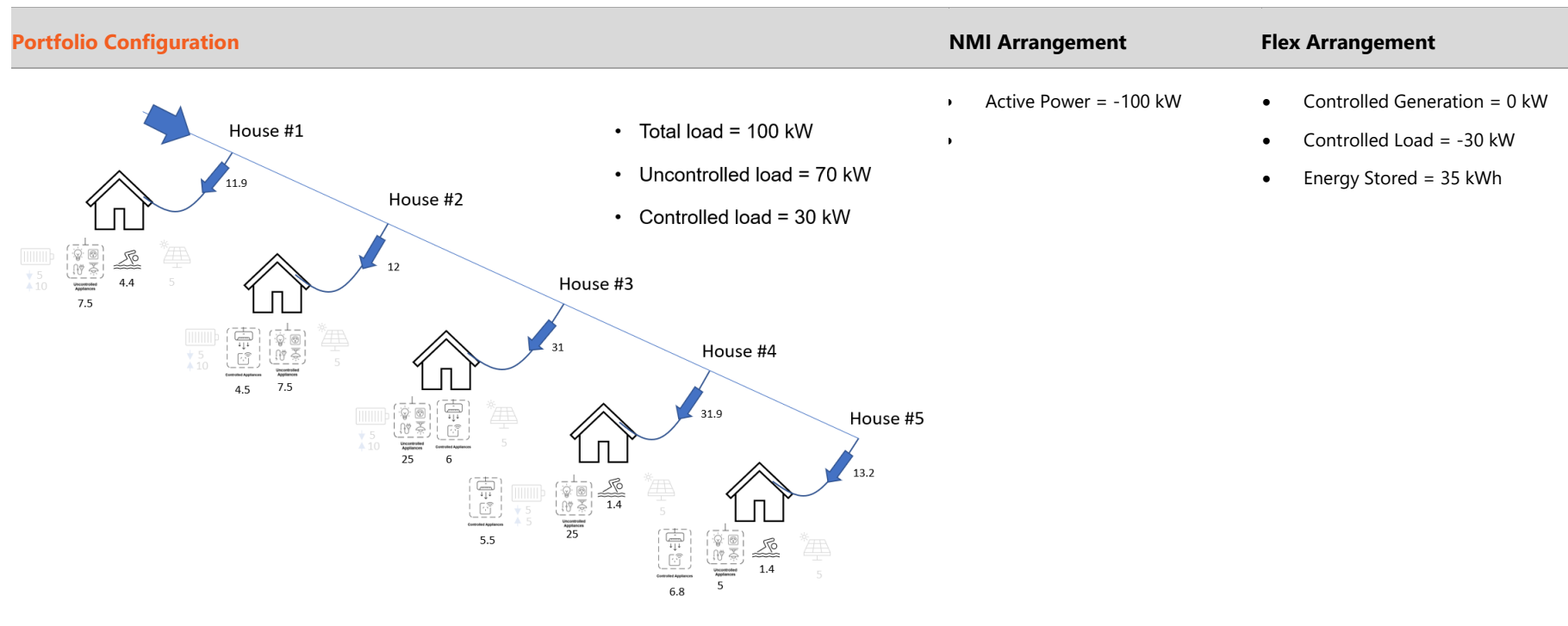

Portfolio Configuration	NMI Arrangement	Flex Arrangement
-------------------------	-----------------	------------------

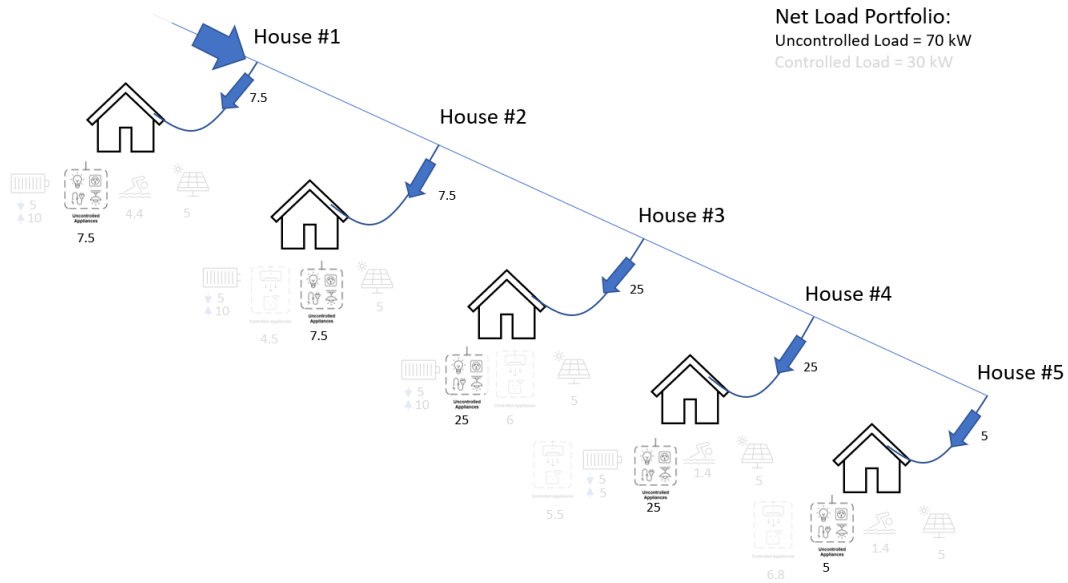

- NMI Arrangement**
- Active Power = -70 kW

- Flex Arrangement**
- Controlled Generation = 0 kW
 - Controlled Load = 0 kW
 - Energy Stored = 35 kWh

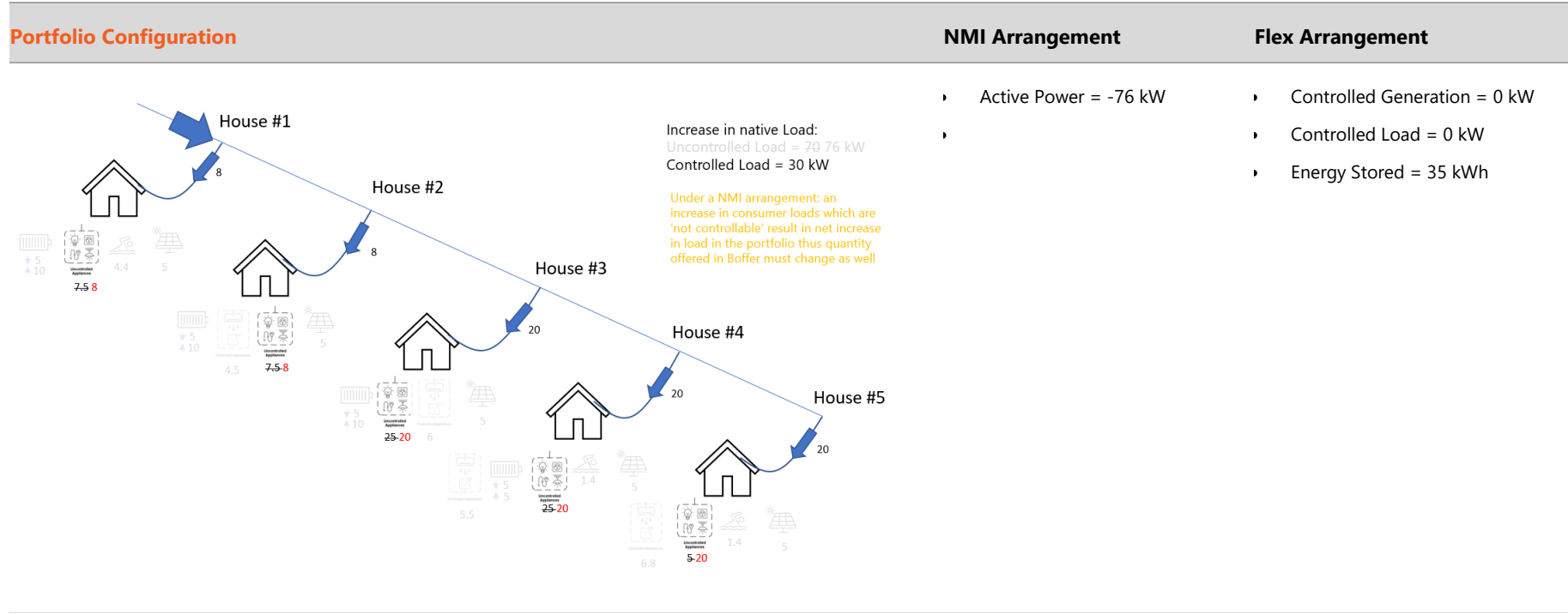

Please note: under the Flex arrangement in the above example active power equals controlled load.

H.2 DUID Telemetry: Net Generation Portfolio

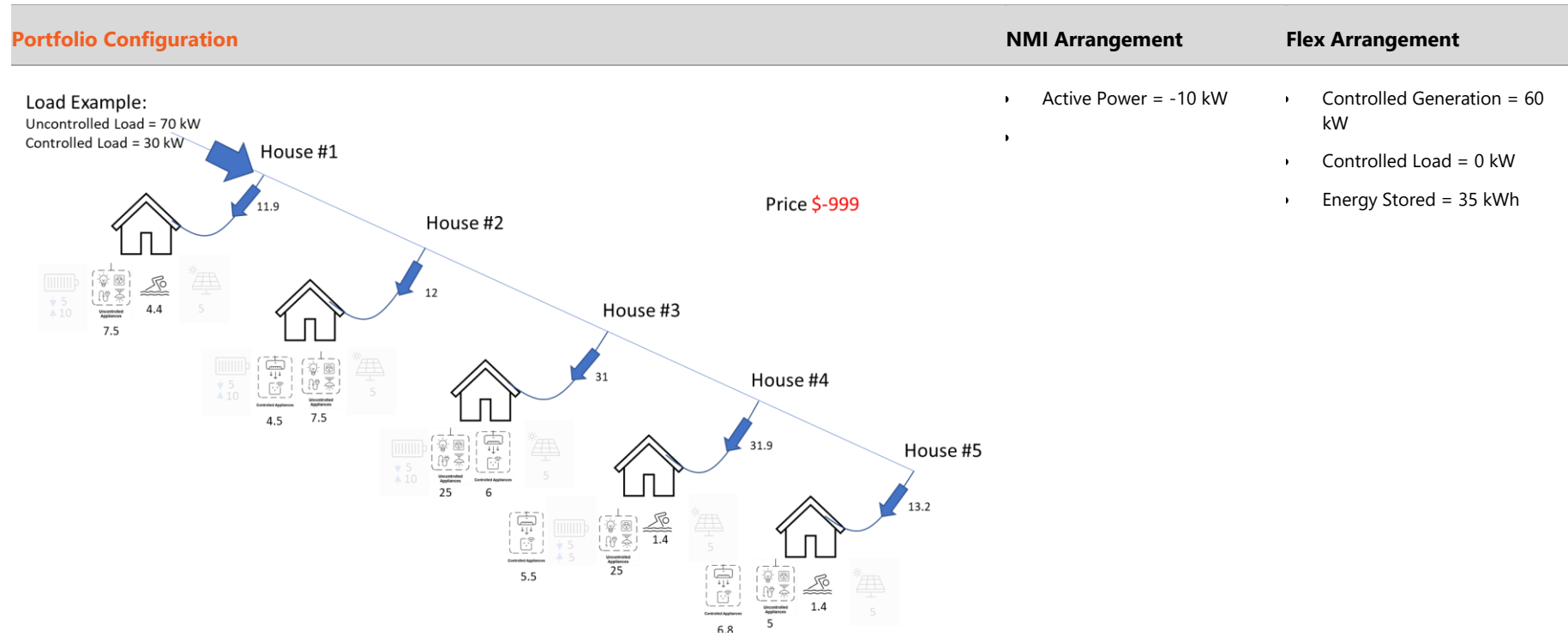

Portfolio Configuration	NMI Arrangement	Flex Arrangement
-------------------------	-----------------	------------------

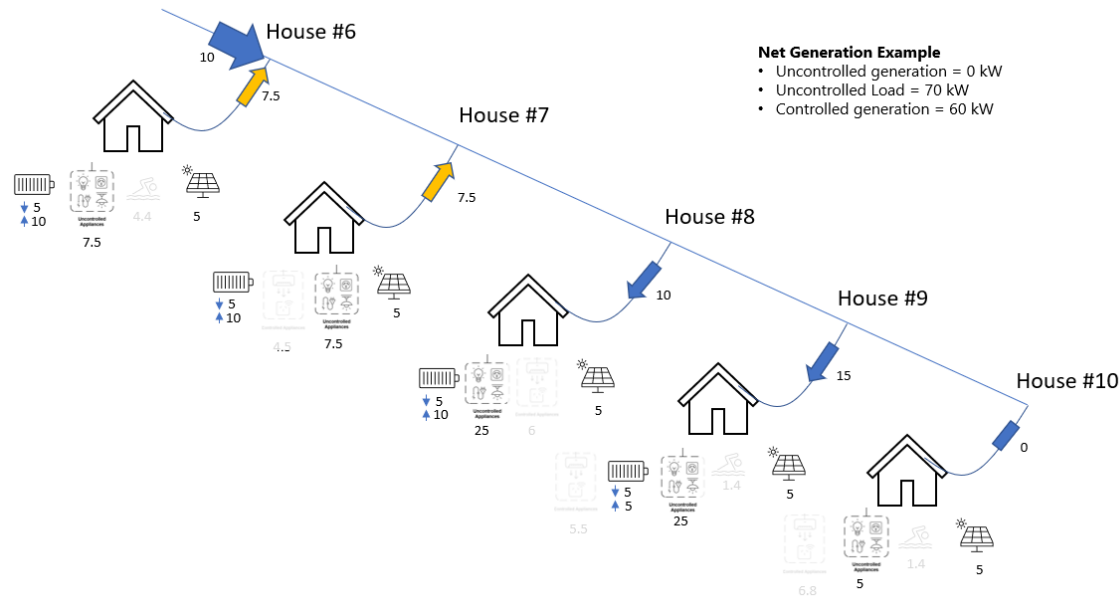

Active Power = -70 kW

- Controlled Generation = 0 kW
- Controlled Load = 0 kW
- Energy Stored = 35 kWh
-

Portfolio Configuration **NMI Arrangement** **Flex Arrangement**

Generation Example:
 Uncontrolled generation = 0 kW
 Uncontrolled Load = 70 kW
 Controlled generation = 60 kW

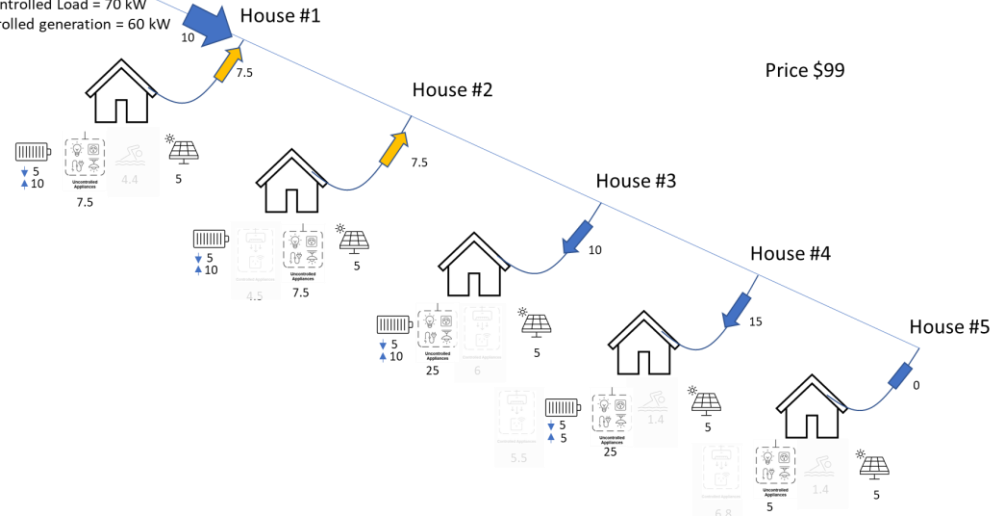

- Active Power = -16 kW
-

- Controlled Generation = 60 kW
- Controlled Load = 0 kW
- Energy Stored = 35 kWh

H.3 DUID Telemetry: Battery Charging

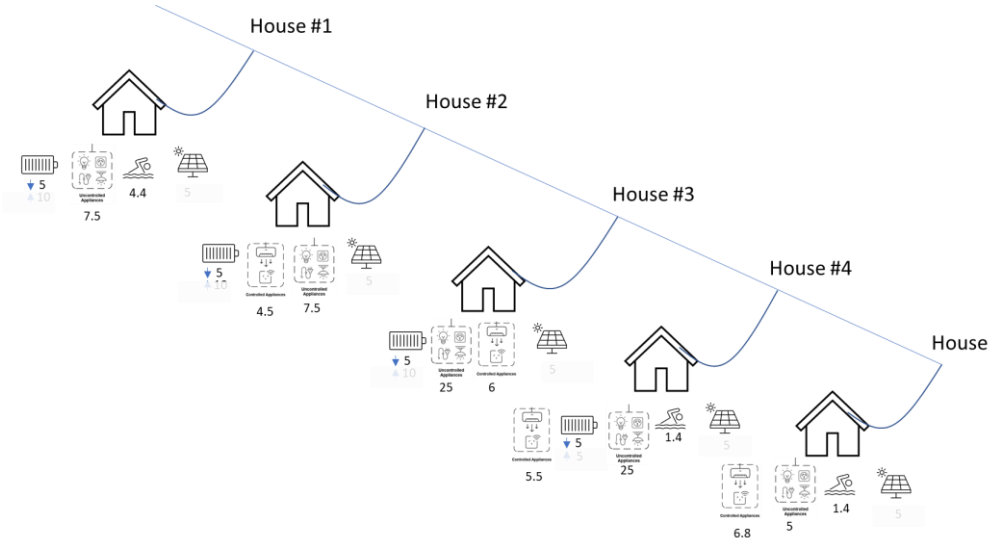
Portfolio Configuration	NMI Arrangement	Flex Arrangement
	<ul style="list-style-type: none"> Active Power = -130 kW 	<ul style="list-style-type: none"> Controlled Generation = 0 kW Controlled Load = -30 kW Energy Stored = 35 kWh

H.4 DUID Telemetry: Battery Discharging

