

2024 General Power System Risk Review Report – Draft

May 2024

Consultation Draft

A report for the National Electricity Market



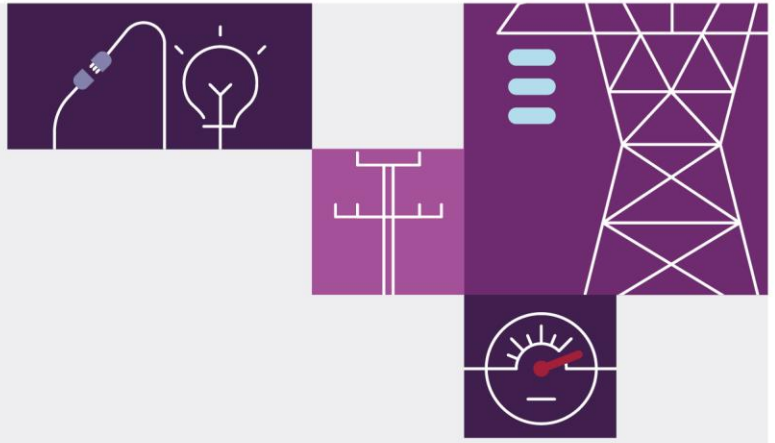

Important notice

Purpose

AEMO has prepared this draft 2024 General Power System Risk Review report as an interim step in its review under clause 5.20A.3 of the National Electricity Rules. This draft report is published for consultation purposes only.

This publication is generally based on information available to AEMO as of 1 May 2024 unless otherwise indicated.

Disclaimer

This document or the information in it may be subsequently updated or amended. This document does not constitute legal or business advice, and should not be relied on as a substitute for obtaining detailed advice about the National Electricity Rules or any other applicable laws, procedures or policies. AEMO has made reasonable efforts to ensure the quality of the information in this document but cannot guarantee its accuracy or completeness.

Accordingly, to the maximum extent permitted by law, AEMO and its officers, employees and consultants involved in the preparation of this document:

- make no representation or warranty, express or implied, as to the currency, accuracy, reliability or completeness of the information in this document; and
- are not liable (whether by reason of negligence or otherwise) for any statements or representations in this document, or any omissions from it, or for any use or reliance on the information in it.

Copyright

© 2024 Australian Energy Market Operator Limited. The material in this publication may be used in accordance with the [copyright permissions on AEMO's website](#).

Version control

Version	Release date	Changes
1.0	30/05/2024	Draft release for feedback

Executive summary

AEMO undertakes the general power system risk review (GPSRR) annually for the National Electricity Market (NEM) in consultation with network service providers (NSPs), in accordance with the National Electricity Rules (NER). The purpose of the GPSRR is to review a prioritised set of power system risks, comprising events or conditions that, alone or in combination, would likely lead to cascading outages or major supply disruptions. For each priority risk, the GPSRR assesses the adequacy of current risk management arrangements and (where appropriate) options for future management. This GPSRR includes updates on key findings and recommendations from the 2023 GPSRR and previous Power System Frequency Risk Reviews (PSFRRs)¹ as well as power system operating incident investigations².

The NEM is supporting a once-in-a-century transformation in the way society considers and consumes energy. Associated with this transformation are a range of factors that influence the operability and resilience of the NEM, such as fewer synchronous generators, increased power transfers through major transmission corridors and concentrated provision of contingency frequency control ancillary services (FCAS) in some regions. The increase in connection of inverter-based resources (IBR) and distributed energy resources (DER) and the proliferation of remedial action schemes (RASs) also poses challenges in maintaining grid stability, voltage and frequency control while managing evolving weather-related risks.

The GPSRR is a central body of work that explores the risks and consequences of non-credible contingencies as well as other system events and conditions that could lead to cascading outages or major supply disruptions, evaluated over a five-year planning horizon. In accordance with NER 5.20A.1(c)(2), the GPSRR assesses options for the management of identified priority risks. The GPSRR builds on and complements other work undertaken by AEMO, such as the *Integrated System Plan (ISP)*, *Engineering Roadmap to 100% Renewables*, and AEMO risk management initiatives.

Priority risk 1: Circuit breaker fail (CBF) event in Latrobe Valley leading to trip of multiple large generating units and Basslink instability

Studies for priority risk 1 involved assessing a fault on the Loy Yang B unit 2 transformer followed by the failure of the single bus coupler circuit breaker (CB) that connects the 500 kV No. 3 bus and Loy Yang B unit 2. This non-credible contingency would result in backup protection operating that, under certain operating conditions, could result in the loss of up to approximately 1,300 megawatts (MW) of generation in Victoria. Studies in the 2024 GPSRR indicate that due to the configuration of Loy Yang substation, this non-credible contingency could result in severe cascading failures, particularly when operating with certain minimum synchronous generator combinations. This risk would be mitigated by installation of an additional CB, or consideration of other options to improve the resilience of the Loy Yang substation. The studies also found that reducing the CBF clearance time reduces the risk of severe cascading failures for this event, highlighting the need for a review of critical CBF contingencies in the NEM.

¹ See <https://aemo.com.au/energy-systems/electricity/national-electricity-market-nem/system-operations/general-power-system-risk-review/power-system-frequency-risk-review>.

² See <https://aemo.com.au/en/energy-systems/electricity/national-electricity-market-nem/nem-events-and-reports/power-system-operating-incident-reports>.

Recommendation 1

Given the criticality of the site for system reliability as well as system strength and security, AEMO recommends that AEMO Victorian Planning (AVP) design and implement a suitable solution to improve the overall resilience of the Loy Yang substation as a priority and share its findings with AEMO for consideration in future GPSRRs. Refer to Section 5.1 for more information on this recommendation.

Priority risk 2: Non-credible loss of the future double-circuit HumeLink 500 kV lines

The studies completed as part of the 2024 GPSRR, as well as Transgrid's assessment in accordance with NER S5.1.8, for priority risk 2 demonstrated that the non-credible loss of both of the planned Bannaby HumeLink 500 kV lines could result in voltage collapse around Bannaby if not managed (for conditions with high northerly HumeLink flows). AEMO completed sensitivity studies tripping load north of Bannaby and generation south of Maragle which indicated this could prevent voltage collapse. However, for the dispatches studied, more than 1,000 megawatts (MW) of generation and load had to be tripped to ensure stability. Also, for cases with high northerly HumeLink flows that were stable following the loss of both Bannaby lines, there is the possibility of low steady-state voltages around Bannaby and Marulan below 0.9 per unit (pu).

The remedial measures currently being undertaken by Transgrid to avoid voltage collapse occurring for the non-credible loss of the HumeLink lines will be further justified following the commissioning of the Snowy 2.0 generation, due to the resultant higher average northerly HumeLink flows. The studies show that the Sydney Ring Option 2 (Southern 500 kV loop) augmentation significantly reduces the risk of voltage collapse around Bannaby for the non-credible loss of the HumeLink lines for northerly flow conditions. The studies completed by AEMO and Transgrid also indicate that there are thermal overloads of the remaining 330 kV network following the non-credible loss of the Maragle or Bannaby HumeLink lines for some dispatch conditions. No power system stability issues following the non-credible loss of the HumeLink lines were identified for dispatch conditions with high southerly flows. However, further studies are required with Snowy 2.0 pumping during low demand periods to assess system stability for the non-credible loss of the HumeLink lines for high southerly flow conditions.

Recommendation 2

Given the potentially significant impact of non-credible loss of HumeLink 500 kV circuits during times of high northerly flows, AEMO recommends that, in accordance with NER S5.1.8, Transgrid continue to:

- Implement cost-effective measures where practical, such as surge arrestors, increased tower clearances or single-phase auto-reclose circuit breakers, to minimise the probability of the tripping of both HumeLink 500 kV circuits.
- Investigate reactive compensation options around Bannaby, accounting for benefits of managing both credible and non-credible contingency events.
- If a scheme is found viable, in consultation with AEMO, design and implement an emergency control scheme to mitigate risks associated with voltage collapse in the Bannaby area as well as 330 kV line thermal overloads by the expected HumeLink in service date of 2026.

Refer to Section 5.2 for more information on this recommendation.

Priority risk 3: UFLS screening studies

Increasing levels of generation from distributed photovoltaics (DPV) are reducing the load on under frequency load shedding (UFLS) circuits, reducing the effectiveness of UFLS. In accordance with NER 5.20A.1, AEMO completed UFLS screening studies for mainland NEM regions to assess the current (FY 2022-23) and future (FY 2028-29) performance and adequacy of existing UFLS schemes and under frequency reserves, and identify any need for remediation. Section 5.3.3 contains a summary of key results from the UFLS screening studies.

Recommendation 3

AEMO recommends that NSPs outside South Australia, in conjunction with AEMO, investigate (and implement wherever possible) low-cost measures, such as dynamic arming, to restore UFLS availability in addition to the existing and planned projects/initiatives detailed in Section 6.2 and Section 6.3. Based on the future FY 2028-29 studies completed as part of the 2024 GPSRR, there will be times of inadequate under frequency reserves across mainland NEM regions to arrest frequency for the significant multiple contingency events considered. AEMO has already determined the South Australia minimum emergency under frequency response (EUFR) requirements³, and the rollout of dynamic arming of UFLS in South Australia and extra battery headroom now available in South Australia mean that this target is expected to be met ~99.8% of the time.

AEMO also recommends that the proposed low-cost Victoria Stage 1 UFLS actions to increase UFLS availability be implemented urgently to reduce risk prior to the commissioning of Project EnergyConnect (PEC) Stage 2, for the non-credible loss of the Victoria – New South Wales Interconnector (VNI).

Refer to Section 5.3 for more information on this recommendation.

2022 PSFRR recommendation

The 2024 GPSRR future UFLS screening studies reinforce an existing recommendation from the 2022 PSFRR for Powerlink and Energy Queensland to identify and implement measures to restore UFLS load, and to collaborate with AEMO on the design and implementation of remediation measures. Therefore, further remediation should be implemented in addition to the already planned initiatives detailed in Section 6.3, such as the review of UFLS settings for large industrial loads.

Review of protected events

South Australia destructive winds limits post PEC Stage 1

AEMO has reviewed the South Australia interconnector transfer limits to be applied during destructive wind conditions following the commissioning of PEC Stage 1 to reduce the likelihood of South Australia islanding following the loss of generation in South Australia. Through the studies undertaken, AEMO identified that no

³ AEMO (May 2024), *Emergency Under Frequency Response for South Australia*, <https://aemo.com.au/-/media/files/initiatives/der/2024/2024-05-21-emergency-underfrequency-requirements-for-south-australia.pdf?la=en&hash=200839621941320C557B67B6DC4DF59A>.

instability was observed in the system below the interconnector satisfactory limits of 250 MW⁴ for PEC Stage 1 and 850 MW⁵ for the Heywood interconnector.

The limits defined here in the 2024 GPSRR apply for destructive wind conditions that could result in the loss of multiple transmission elements causing generation disconnection in South Australia to reduce the likelihood of South Australia islanding. This is separate to the South Australia import constraints that are invoked for destructive wind conditions impacting Heywood where South Australia islanding is reclassified as credible. As PEC Stage 1 will be inter-tripped with Heywood, the South Australia destructive wind transfer import limit for the credible loss of Heywood will remain at 250 MW.

Through studies completed in the 2024 GPSRR, AEMO has determined that after the commissioning and internetwork testing of PEC Stage 1 is completed, destructive wind transfer limits into South Australia of 350 MW for Heywood and 50 MW for PEC Stage 1 will mitigate the risk of exceeding the satisfactory South Australia interconnector limits for a nominal 600 MW South Australia generation contingency size. These limits also allow for up to 100 MW of interconnector drift.

AEMO has identified that DPV generation shake-off in response to power system faults can further increase the total South Australia contingency size. To account for this impact, AEMO will dynamically reduce the stated maximum destructive wind transfer limits by 10% of the online South Australia DPV generation. Refer to Section 5.4 for more information on this recommendation.

Note that the limits stated above assume system normal conditions and the full capacity of Heywood and PEC Stage 1. If there are significant system outages or other constraints that limit the effective capacity of Heywood or PEC Stage 1, the destructive wind transfer limits will be reduced accordingly. If PEC Stage 1 is out of service or constrained to 0 MW, the existing 250 MW interconnector limit into South Australia will apply.

The previous South Australia destructive winds protected event required AEMO to take steps to actively manage the risk that, during periods of forecast destructive wind conditions in South Australia, the loss of multiple transmission elements could cause up to 500 MW of generation to disconnect in South Australia (being a contingency that is assumed to be reasonably possible when destructive winds are forecast). Since 2019, the system dispatch and operating conditions in South Australia have changed due to several different factors, which impact the appropriate nominal contingency size considered in determining the destructive wind limits. AEMO has determined as part of its analysis that an increased nominal contingency size of 600 MW should be used to calculate the destructive wind limits (discussed further in Section 4.2.4). The nominal contingency size used to calculate the destructive wind limits will be reviewed following any major changes in the South Australia system or operational conditions.

⁴ Based on 15-minute thermal rating of the Buronga phase shifting transformer (PST).

⁵ Heywood satisfactory stability limit is 850 MW based on existing constraints for voltage and transient stability for the largest generation credible contingency in South Australia. In four of the five non-credible contingency events where South Australia has separated from Victoria since 1999, a sudden loss of generation (around 500 MW) in South Australia at times of high import from Victoria resulted in a rapid increase of imports before protection systems disconnected the Heywood interconnector on detected loss of synchronism between South Australia and the remainder of the NEM. While the exact tripping conditions are complex, analysis of these events in the *Black System South Australia 28 September 2016 – Final Report* suggests that the Heywood interconnector's protection will operate at approximately 900 MW, depending on system conditions. See Table 11 in https://www.aemo.com.au/-/media/files/electricity/nem/market_notices_and_events/power_system_incident_reports/2017/integrated-final-report-sa-black-system-28-september-2016.pdf?la=en&hash=7C24C97478319A0F21F7B17F470DCA65.

Possible protected event framework rule change request

To address recommendation 9 from the published 2023 GPSRR final report, AEMO is undertaking a review of the protected event framework and considering whether a rule change submission to enhance the protected event framework is necessary. This includes evaluating whether the existing protected event framework alongside the updated Power System Security Guidelines (SO_OP_3715)⁶ allow AEMO to effectively manage existing identified power system risks. See Section 7.4 for more details.

Review of risk management measures

The GPSRR considers high impact power system events that pose significant risks and may lead to cascading outages or major supply disruptions. Significant events and operational challenges that have occurred since the 2023 GPSRR include:

- June 2023, loss of supervisory control and data acquisition (SCADA) and line protection at Keilor Terminal Station.
- November 2023, trip of Robertstown – Tungkillo 275 kV No. 1 line and the Robertstown No. 1 and No. 2 Synchronous Condensers.
- November 2023, operation with minimum system strength requirements in New South Wales.
- February 2024, trip of Moorabool – Sydenham 500 kV No. 1 and No. 2 lines.

In addition to the evaluation of the priority high impact events selected for the 2024 GPSRR in accordance with NER 5.20A.1 summarised above, for completeness this GPSRR also provides an overview of risk mitigation measures encompassing Emergency Frequency Control Schemes (EFCs), operational capabilities and other emerging risks in the context of an evolving power system. The recommendations below relate to identified risks that have wider ranging impacts and have the potential to further increase the likelihood or consequence of the priority risks. Based on the review of recent events, internal risk assessments and the current measures in place discussed in Section 6, AEMO makes the following recommendation.

Recommendation 4

AEMO anticipates significant operational challenges to emerge as thermal generating units retire and will develop operational procedures for scenarios where insufficient synchronous units are available for AEMO to direct to meet the minimum regional system strength requirements. This will include a BowTie risk assessment that incorporates the appropriate limit advice and contingency plans from NSPs. Refer to Section 6.4.4 for more information on this recommendation.

2023 GPSRR Recommendation 4

As part of the 2023 GPSRR, AEMO recommended that each participating jurisdiction develop and coordinate emergency reserve and system security contingency plans, which can be implemented at short notice if required to address potential risks. These plans should be for an appropriate level of capacity for the region, and encompass details of the generation technology, connection point and connection arrangement, fuel supply

⁶ Which included updated reclassification criteria to reflect the Australian Energy Market Commission's (AEMC's) National Electricity Amendment (Enhancing operational resilience in relation to indistinct events) Rule 2022 .

adequacy, environmental considerations, construction, and commissioning timelines as well as equipment availability and lead times. Given the widespread thermal generator retirements, AEMO notes that this is a growing priority for jurisdictions to action. Refer to Section 6.4.3 of the 2024 GPSRR for more information on this recommendation.

Additional recommendations and findings

As a result of the 2024 GPSRR priority risk studies, as well as the review of risk mitigation measures, operational capabilities and other emerging risks, AEMO also makes the additional findings and recommendations listed in Table 1.

Table 1 Additional recommendations and findings

	Recommendation/finding
5	<p><u>Evaluating post PEC-1 operational mitigations for non-credible loss of Heywood</u></p> <p>There is currently a constraint which limits import into South Australia over the Heywood interconnector based on the net UFLS load, DPV generation, power system inertia and the availability of Fast Active Power Response (FAPR).</p> <p>There is also currently a constraint set in place to maintain South Australia RoCoF below 2 hertz per second (Hz/s) immediately following the non-credible loss of the Heywood interconnector, which was introduced to meet the requirements of under regulation 88A of the Electricity (General) Regulations 2012 (SA).</p> <p>Given PEC Stage 1 will be inter-tripped for the non-credible loss of the Heywood interconnector, these constraints will remain in place following commissioning of PEC Stage 1.</p>
6	<p><u>UFLS data quality</u></p> <p>Currently there is no real-time visibility of Queensland, New South Wales and Victoria UFLS availability. In Victoria, locations of the UFLS relays align closely with the locations of transmission use of system charge (TUoS) metering in the Victorian network. As AEMO has direct access to this TUoS metering, it is possible for AEMO to extract and aggregate half-hourly load measurements to estimate the total amount of load in the UFLS at each frequency trip setting, in each half-hour on an ad hoc basis. For Queensland and New South Wales, the existing data is from 2018 to 2020, and must be scaled based on current DPV installed capacity and regional operational demand. This poses an operational risk, as there is no guarantee that the estimated UFLS availability in Queensland and New South Wales is accurate.</p> <p>AEMO therefore strongly recommends real-time visibility of UFLS availability is established in all mainland NEM regions (similar to that which exists for South Australia). Given escalating operational risks, AEMO recommends this occur without delay.</p>
7	<p><u>Updates to UFLS schedules and procedures</u></p> <p>There is an urgent need to review and update the UFLS schedules used by the AEMO control room, as well as the associated procedures to ensure that they reflect the actual UFLS availability for each region. The current lack of accurate UFLS information available to the AEMO control room poses a significant operational/security risk, particularly for non-credible regional islanding events.</p> <p>AEMO therefore recommends that NSPs work with AEMO to provide up-to-date and accurate UFLS availability information to support AEMO’s review of UFLS adequacy.</p>
8	<p><u>UFLS scheme review</u></p> <p>Studies completed by AEMO as part of the 2024 GSPRR highlight opportunities to:</p> <ul style="list-style-type: none"> • Consolidate the 121 UFLS bands in NSW to reduce (unnecessary) complexity. • Review the Queensland – New South Wales interconnector (QNI) inhibit scheme to ensure it remains effective at preventing QNI instability for remote frequency disturbances south of Queensland.
9	<p><u>RAS guidelines review</u></p> <p>Given the growing number and complexity of NEM RASs, AEMO recommends that, as part of the existing obligations under NER S5.1.8 and S5.14, NSPs in collaboration with AEMO engage in extensive and detailed joint planning. In the design and testing of RASs, the impact on other NEM regions/inter-regional interconnectors should be considered to ensure that all existing and future RASs operate effectively and do not cause adverse interactions or exacerbate non-credible contingency events. This includes anticipated schemes such as the Waratah Super Battery (WSB) System Integrity Protection Scheme (SIPS), South Australia Interconnector Tripping (SAIT) RAS and QNI Special Protection Scheme (SPS).</p> <p>Given the increasing consequences of non-credible events, and the need to give effect to appropriate mitigations, AEMO plans to review the RAS guidelines, including consideration of:</p>

	Recommendation/finding
	<ul style="list-style-type: none"> • Provision of limit advice associated with operational conditions where emergency controls are ineffective • System strength impacts. • Anticipated generator retirements. • NSP joint planning requirements under 5.14. <p>Refer to Section 6.6 for more information on this recommendation.</p>
10	<p>Managing risks associated with South Australia lightning trips</p> <p>To reduce the number of transmission line trips due to lightning in South Australia, AEMO recommends that ElectraNet investigate South Australia transmission tower earthing and lightning protection based on recent contingency events to identify or rule-out any existing design weaknesses. For example, on 11 December 2023 there were 27 trips in South Australia due to lightning in ~12 hours. Refer to Section 6.9 for more information on this recommendation.</p> <p>Additionally, consistent with NER 5.20A.1, AEMO has identified the potential need for a RAS to manage South Australia intra-regional separation. Therefore, to reduce the likelihood that multiple trips due to lightning or other risk factors in South Australia result in severe cascading failures, AEMO recommends, in accordance with NER S5.1.8, that ElectraNet investigates the suitability of a RAS to prevent South Australia intra-regional separation. Refer to Section 6.9 for more information on this recommendation.</p>
11	<p>Managing risks associated with localised aggregated battery energy storage system (BESS) response to remote frequency disturbances</p> <p>The location of large-scale BESS greatly impacts power system stability, as fast discharging/charging in response to remote frequency disturbances could cause large active power swings on interconnectors, potentially resulting in instability. In particular, South Australia has significantly greater large-scale BESS capacity installed compared to the rest of the mainland NEM. This means that there is potentially an increasing risk that the aggregate response of the BESS in South Australia to a remote generation contingency for South Australia export conditions, and to a remote load contingency for South Australia import conditions, could result in large swings on the Heywood interconnector and potential for instability, in particular prior to the commissioning of PEC Stage 2.</p> <p>At the time of finalising this draft report, AEMO is working with ElectraNet to consider suitable remedial measures to address this risk such as those detailed in Section 6.14.2.</p>

Potential focus areas for the 2025 GPSRR

Based on the outcomes of the draft 2024 GPSRR, AEMO is considering the following focus areas for the 2025 GPSRR:

- Studies completed for priority risk 1 (CBF event in Latrobe Valley leading to trip of multiple large generating units and Basslink instability) highlight the potential impact of CBF events, particularly in the context of operation with fewer synchronous generators online. In the next GPSRR, AEMO plans to review critical CBF contingencies in the NEM which have the potential to trip multiple synchronous generating units.
- Given the rapid changes in the power system, AEMO recommends that NSPs prioritise forward looking studies in accordance with NER S5.1.8 to investigate the impact of all generation retirements expected in the next five years on power system constraints and the risk and consequence of non-credible and multiple contingencies in their network and share the findings with AEMO for consideration in future GPSRRs. As part of this, NSPs should explicitly specify and rate the risks associated with anticipated generation retirements as part of the GPSRR risk assessment process. Refer to Section 6.14.4 for more information on the risks associated with generation retirements.

Industry information session

On 7 June 2024, AEMO plans to hold an industry question and answer session on the draft GPSRR. Please email gpsrr@aemo.com.au for a calendar invitation.

Invitation for submissions

AEMO is seeking feedback from registered participants interested in the GPSRR on this draft report, in particular the findings and recommendations, and potential focus areas for the 2025 GPSRR (which will be consulted on separately under NER 5.20A.2(c)(3)). Relevant submissions will contribute to the finalisation of the 2024 GPSRR report, due for publication by 31 July 2024.

If you would like to provide feedback, please email it to gpsrr@aemo.com.au. Written submissions will be accepted until 5.00 pm (AEST) 14 June 2024.

Relevant submissions will be published on AEMO's website, subject to AEMO's consultation submission guidelines⁷. AEMO may alternatively elect to summarise the substance of relevant issues raised that are common across multiple submissions. Please indicate in your submission if there are any parts of your submission you would like kept confidential, with reasons why.

⁷ See https://aemo.com.au/-/media/files/stakeholder_consultation/working_groups/industry_meeting_schedule/aemo-consultation-submission-guidelines---march-2023.pdf?la=en.

Contents

Executive summary	3
Abbreviations	15
1 Introduction	19
1.1 Purpose	19
1.2 Priority risks considered in the review	21
1.3 Acknowledgements	21
1.4 Stakeholder engagement	22
1.5 Risk management in the NEM	23
2 Industry in transition	25
2.1 Generation mix	25
2.2 Distributed energy resources (DER)	27
3 Review of incidents	29
3.1 Summary of reviewable operating incidents in 2023-24	30
3.2 Relevant recent incidents	31
4 Study methodology	35
4.1 Study overview	35
4.2 PEC Stage 1 destructive wind limit studies modelling approach	44
4.3 Study acceptance criteria	52
5 Study results and observations	53
5.1 Priority risk 1: CBF event in Latrobe Valley leading to trip of multiple large generating units and Basslink instability	53
5.2 Priority risk 2: Non-credible loss of the future double-circuit HumeLink 500 kV lines	57
5.3 Priority risk 3: UFLS screening studies	61
5.4 PEC Stage 1 destructive wind limit studies	75
6 Review of risk management measures	80
6.1 OFGS review	80
6.2 Emergency under frequency management	80
6.3 Future UFLS projects	87
6.4 Emergency reserves and services	89
6.5 Fuel supply interruptions/supply scarcity issues	102

6.6	Remedial action scheme interactions and maloperation risks	103
6.7	Interconnector drift	107
6.8	Power system modelling improvements	108
6.9	Weather-related risks	110
6.10	Failure of SCADA systems	115
6.11	Substation hardening	116
6.12	Communication-related risks	117
6.13	Cyber-related risks	118
6.14	Other emerging risks	121
7	Protected events	133
7.1	Existing protected event	133
7.2	Post PEC Stage 1	134
7.3	Non-credible synchronous separation of South Australia from the rest of the NEM	136
7.4	Protected event framework review	137

Tables

Table 1	Additional recommendations and findings	8
Table 2	NER requirements related to GPSRR	20
Table 3	Reviewable incidents criteria	29
Table 4	The minimum synchronous generator combinations used for Queensland, New South Wales, and South Australia	36
Table 5	The minimum synchronous generator combinations used for Victoria	37
Table 6	HumeLink contingencies	39
Table 7	Key NEM parameter values of selected HumeLink future dispatches	41
Table 8	Key NEM parameter values of Transgrid HumeLink cases	41
Table 9	Historical UFLS contingencies	43
Table 10	Future UFLS contingencies	43
Table 11	SA AC interconnector capacities, post PEC commissioning	47
Table 12	South Australia wind generation changes in registered capacity, 2017-18 to 2022-23	50
Table 13	Initial base cases	51
Table 14	Legend for historical results table	53
Table 15	Priority risk 1 study results (Basslink flow Tasmania to Victoria)	53

Table 16	Priority risk 1 PoW sensitivity study results	55
Table 17	Future study results	57
Table 18	Future study results: Transgrid cases	57
Table 19	Maximum northerly HumeLink flow at which no voltage collapse occurs (sensitivity studies)	59
Table 20	RAS sensitivity results	60
Table 21	Historical study results summary against acceptance criteria	62
Table 22	Historical study results summary against acceptance criteria	63
Table 23	Future study results summary against acceptance criteria	67
Table 24	Future study results summary against acceptance criteria	68
Table 25	UFLS screening studies results summary	73
Table 26	PEC Stage 1 destructive wind limit study base case results	75
Table 27	Contingency size sensitivity study results	76
Table 28	Summary of mainland NEM regions UFLS remediation projects	81
Table 29	Summary of future UFLS rectification areas	87
Table 30	RAS testing guidelines	106
Table 31	Summary of recent lightning trips in South Australia	113
Table 32	Current NEM regional Installed large-scale BESS capacity (including plants undergoing commissioning)	123

Figures

Figure 1	Forecast NEM capacity to 2050, 2024 ISP <i>Step Change</i> scenario	25
Figure 2	Root cause of reviewable operating incidents	30
Figure 3	Simplified single line diagram of Loy Yang power station – CB statuses post fault clearance	36
Figure 4	HumeLink augmentation simplified single line diagram	39
Figure 5	Project Energy Connect Stage 1 single line diagram	47
Figure 6	Map of South Australian transmission system showing location of 2016 black system event faults and significant new connections since 2019	50
Figure 7	VIC_39 case, Basslink DC current	55
Figure 8	Basslink commutation failure times for sensitivity studies	56
Figure 9	South Australia total destructive winds import limit versus South Australia DPV generation	78
Figure 10	Percentage of time in reverse flow for anonymised sub-transmission loops in the Victorian UFLS scheme	84
Figure 11	Maximum reverse power flows from anonymised sub-transmission loops in the Victorian UFLS scheme	84



Figure 12	Future PMU installations in the NEM	99
Figure 13	Synchronous units projected online under <i>Step Change</i> scenario, New South Wales, AEMO 2023 System Strength Report	101
Figure 14	NEM renewable energy generation potential and penetration up until Q1 2024	128

Draft

Abbreviations

Abbreviation	Term	Abbreviation	Term
2ph-G	two phase-to-ground	MW	megawatt/s
3P	three-phase	MWh	megawatt hour/s
3ph-G	three phase-to-ground	MWs	Megawatt second/s
AC	alternating current	NBN	National Broadband Network
AEC	Australian Energy Council	NEM	National Electricity Market
AEMC	Australian Energy Market Commission	NEMDE	National Electricity Market Dispatch Engine
AER	Australian Energy Regulator	NER	National Electricity Rules (NER followed by a number indicates that numbered rule or clause of the NER)
AGC	automatic generation control	NERC	North American Electric Reliability Corporation
AMI	advanced metering infrastructure	NMAS	non-market ancillary services
APC	administered price cap	NMI	National Metering Identifier
ARENA	Australian Renewable Energy Agency	NSCAS	network support and control ancillary services
ASEFS2	Australian Solar Energy Forecasting System Phase 2	NSP	network service provider
ASD	Australian Signals Directorate	ODP	optimal development path
AVP	AEMO Victorian Planning	OEM	original equipment manufacturer/s
BESS	battery energy storage system/s	OFGS	over frequency generation shedding
BLTS	Brooklyn Terminal Station	OPDMS	Operations and Planning Data Management System
CB	circuit breaker	PASA	projected assessment of system adequacy
CBF	circuit breaker failure	PSDCS	Power System Data Communication Standard
CDC	cyber defensible core	PD	pre-dispatch
CER	consumer energy resources	PEC	Project EnergyConnect
CMLD	composite load model	PFR	primary frequency response
CRC	cybersecurity co-operative research centre	PFRR	primary frequency response requirements
CT	current transformer	PMU	phasor measurement unit
DC	direct current	POE	probability of exceedance
DER	distributed energy resources	PoW	point-on-wave
DNSP	distribution network service provider	PSC	Power Systems Consultants
DPTS	Deer Park Terminal Station	PSCAD™	Power System Computer Aided Design
DPV	distributed photovoltaics	PSFRR	Power System Frequency Risk Review
DSP	demand side participation	PSMRG	Power System Modelling Reference Group
DWDM	dense wavelength-division multiplexing	PSS®E	Power System Simulation for Engineering
EAAP	energy adequacy assessment projection	PSSG	Power System Security Guidelines
EAPT	Emergency Alcoa-Portland Potline Tripping	PSSWG	Power System Security Working Group
EFCS	emergency frequency control scheme	pu	per unit
EMS	energy management system	PV	photovoltaics
EMT	electromagnetic transient	PVC	polyvinyl chloride
EPC	engineering, procurement and construction	PVNSG	PV non-scheduled generation

Abbreviation	Term	Abbreviation	Term
ESS	enhancing essential system services	QNI	Queensland – New South Wales Interconnector
ESOO	electricity statement of opportunities	RAS	remedial action scheme
ESS	essential system services	RERT	reliability and emergency reserve trader
EUFR	emergency under frequency response	REZ	renewable energy zone
FAPR	fast active power response	RIT-T	regulatory investment test for transmission
FAT	factory acceptance testing	RMS	root mean squared
FCAS	frequency control ancillary services	RoCoF	rate of change of frequency
FCSPS	frequency control system protection scheme	RRO	Retailer Reliability Obligation
FFR	fast frequency response	RUG	Releasable User Guide
FOS	frequency operating standard	s	second/s
FRT	fault ride-through	SAIT RAS	South Australia Interconnector Trip Remedial Action Scheme
FUM	forecast uncertainty measure	SAT	site acceptance testing
FY	financial year	SC	synchronous condenser/s
GFT	generator fast trip	SCADA	supervisory control and data acquisition
GMD	geomagnetic disturbances	SESS	South East Switching Station
GPSRR	general power system risk review	SIPS	system integrity protection scheme
GW	gigawatt/s	SISC	System Integration Steering Committee
HIC	Heywood interconnector	SPS	special protection scheme/s
HSM	high speed monitoring	SRAS	system restart ancillary services
HV	high voltage	SSSP	System Strength Service Provider
HVDC	high voltage direct current	ST	short term
Hz	hertz	SVC	static volt-ampere reactive compensator
Hz/s	hertz per second	SYTS	Sydenham Terminal Station
IASR	inputs assumptions and scenarios report	TAPR	transmission annual planning report
IBR	inverter-based resources	TIPS	Torrens Island Power Station
ICCP	Inter-Control Centre Communications Protocol	TNSP	Transmission Network Service Provider
ICS	industrial control system	ToR	terms of reference
IECS	interconnector emergency control scheme	TTS	Thomastown Terminal Station
IRA	<i>Inflation Reduction Act</i>	TUoS	Transmission Use of System
IRM	interim reliability measure	UFLS	under frequency load shedding
IRR	interim reliability reserves	USE	unserved energy
ISP	<i>Integrated System Plan</i>	VAPR	<i>Victorian Annual Planning Report</i>
JSSC	Jurisdictional System Security Coordinator	VEEC	Victorian Electricity Emergency Committee
JLTS	Jeeralang Terminal Station	VNI	Victoria – New South Wales Interconnector
km	kilometre/s	VPP	virtual power plant
KTS	Keilor Terminal Station	VRE	variable renewable energy
kV	kilovolt/s	VREFS	variable renewable energy forecasting system
LCC	line commutated converter	VSC	voltage source converter
MASS	Market Ancillary Service Specification	WAMPAC	wide area monitoring protection and control

Abbreviation	Term	Abbreviation	Term
MCB	miniature circuit breaker/s	WAMS	wide area monitoring scheme
MLTS	Moorabool Terminal Station	WAPS	wide area protection scheme
ms	millisecond/s	WEM	Wholesale Electricity Market
MV	medium voltage	WMTS	West Melbourne Terminal Station
MVA	Megavolt ampere/s	WSB	Waratah Super Battery
MVA _r	megavolt amperes reactive		

Draft

Key report terms

This document uses many terms that have meanings defined in the National Electricity Rules (NER). The NER meanings are adopted unless otherwise specified.

Term	Definition
Satisfactory operating state	<p>The power system is in a satisfactory operating state when:</p> <ul style="list-style-type: none"> • Power system frequency is within the normal operating frequency band • Voltage magnitudes are within relevant limits • Current flows on all transmission lines are within equipment ratings • All other plant forming part of the power system is being operated within its ratings • The power system is being operated such that fault potential is within circuit breaker capabilities • The power system is considered stable
Secure operating state	<p>The power system is defined to be in a secure operating state when:</p> <ul style="list-style-type: none"> • The power system is in a satisfactory operating state • The power system will return to a satisfactory operating state following any credible contingency event
Credible contingency event, or credible contingency	<p>A contingency event is considered credible when AEMO considers its occurrence to be reasonably possible in the surrounding circumstances including the technical envelope. Without limitation, examples of credible contingency events are likely to include:</p> <ul style="list-style-type: none"> • the unexpected automatic or manual disconnection of, or the unplanned reduction in capacity of, one operating generating unit; or • the unexpected disconnection of one major item of transmission plant (e.g. transmission line, transformer or reactive plant) other than as a result of a three-phase electrical fault anywhere on the power system.
Non-credible contingency event, or non-credible contingency	<p>A contingency event other than a credible contingency event. Without limitation, examples of non-credible contingency events are likely to include:</p> <ul style="list-style-type: none"> • three-phase electrical faults on the power system; or • simultaneous disruptive events such as: <ul style="list-style-type: none"> – multiple generating unit failures; or – double-circuit transmission line failure (such as may be caused by tower collapse).
Protected event	<p>A non-credible contingency event that the Reliability Panel has declared to be a protected event under NER 8.8.4 after consultation on a request made by AEMO, where that declaration has not been revoked.</p>

1 Introduction

1.1 Purpose

AEMO has prepared this consultation draft as an interim step in the development of the 2024 General Power System Risk Review (GPSRR), undertaken under rule 5.20A of the National Electricity Rules (NER). AEMO undertakes a GPSRR for the National Electricity Market (NEM) at least once a year, considering a prioritised set of risks comprising contingency events as well as other events and conditions that AEMO considers would be likely to lead to cascading outages or major supply disruptions.

The priority risks for the 2024 GPSRR and AEMO's assessment approach were determined through a process of initial consultation with network service providers (NSPs), followed by broader public consultation in late 2023⁸.

This draft report presents:

- The results of AEMO's assessment to date of the three priority risks detailed in Section 1.2, including a review of the current arrangements for management of those risks (see Section 4 and Section 5).
- Where required, technically and economically feasible options for the future management of those priority risks, and draft recommended options (see Section 5).
- AEMO's assessment of the current operational arrangements to manage the risk of destructive winds in South Australia (see Section 7).
- AEMO's determination of the South Australia import transfer limits during destructive wind conditions following the commissioning of PEC Stage 1 (see Section 4.2 and Section 5.4).
- A summary of the ongoing work to assess and identify required modifications to existing emergency frequency control schemes (see Section 6).

1.1.1 NER requirements related to the GPSRR

NER 5.20A sets out the scope of the GPSRR and the matters to be assessed and reported on. AEMO's findings and recommendations on these matters, where actioned, intersect with several other NER requirements and responsibilities, particularly, but not exclusively, in relation to emergency frequency control schemes (EFCs) (primarily under frequency load shedding (UFLS)). Many of these rules apply independently of the GPSRR and its recommendations.

Table 2 lists other key NER obligations that are particularly relevant to managing the power system risks that may be covered by the GPSRR.

⁸ Finalised in AEMO's 2024 GPSRR Approach Paper, 17 November 2023, Consultation material on the 2023 GPSRR approach, at <https://aemo.com.au/consultations/current-and-closed-consultations/2024-gpsr-review>.

Table 2 NER requirements related to GPSRR

NER clause	Description
4.2.3A	Reclassification of contingency events from non-credible to credible in abnormal conditions affecting the power system, as recently amended ^A to make clear provision for reclassification and appropriate management actions in conditions that may have a widespread impact, where it is not practical to identify the specific assets at risk.
4.3.1(k), (p1)	System security – AEMO’s responsibilities that relate to, or are impacted by, the responses of EFCS.
4.3.1(n), 4.3.2	System security – AEMO to provide information to facilitate resolution of risks outside AEMO’s control; requirements for AEMO to develop EFCS settings schedules in consultation with NSPs and (as relevant), jurisdictional system security coordinators and generators.
4.3.4	NSPs to cooperate with AEMO to achieve power system security responsibilities, and specifically in relation to the design and implementation of EFCS and the provision of sufficient interruptible loads.
4.3.5, S5.3.10, S5.6 Part A (k)	Market Customer responsibilities for providing interruptible load from facilities with at least 10 megawatts (MW) peak demand.
5.12.1(b)(7) and 5.13.1(d)(6)	NSP review of interactions between emergency controls, emergency frequency controls, protection systems and control systems (published in its Transmission Annual Planning Report or Distribution Annual Planning Report).
5.14, 5.16, 5.17	Joint planning obligations where recommended investments involve more than one NSP, and the application of the regulatory investment test to investments other than protected event EFCS.
S5.1.8 (including reporting requirements under 5.12.2(c)(9))	NSP planning obligation to consider non-credible contingency events – such as busbar faults which result in tripping of several circuits, uncleared faults, double-circuit faults and multiple contingencies – which could potentially endanger the stability of the power system. Where consequences are likely to involve severe disruption, NSP and Registered Participants must install, maintain and upgrade emergency controls in consultation with AEMO.
S5.1.10.1(a)	NSPs, in consultation with AEMO, to ensure that UFLS loads are sufficient to minimise or reduce the risk that frequency will exceed the extreme tolerance limits in the event of multiple contingency events.
S5.1.10.2	Distribution network service provider (DNSP) obligations to cooperate with transmission network service providers (TNSPs), provide and maintain UFLS facilities and apply settings as required.

A. National Electricity Amendment (Enhancing operational resilience in relation to indistinct events) Rule 2022. Australian Energy Market Commission (AEMC) consultation material, <https://aemc.gov.au/rule-changes/enhancing-operational-resilience-relation-indistinct-events>.

1.1.2 GPSRR relationship with other reports

The GPSRR draws inputs from, and in turn informs and supports, a number of related reports and processes owned by AEMO and transmission network service providers (TNSPs). These include:

- AEMO’s *Inputs, Assumptions and Scenarios Report* (IASR)⁹, which presents a range of credible future scenarios representing possible policy settings and technology updates, and feeds into AEMO’s planning publications.
- AEMO’s *Integrated System Plan* (ISP)¹⁰, a whole of system plan for the efficient development of the power system needs for a planning horizon of at least 20 years in the long-term interests of consumers of electricity.
- AEMO’s *System Security Reports*¹¹, in which AEMO considers the need for any power system security and reliability services in the NEM over the coming five years as part of its obligations to assess system strength, inertia and network support and control ancillary services (NSCAS) requirements and shortfalls.

⁹ At <https://aemo.com.au/-/media/files/major-publications/isp/2023/2023-inputs-assumptions-and-scenarios-report.pdf?la=en>.

¹⁰ At https://aemo.com.au/-/media/files/stakeholder_consultation/consultations/nem-consultations/2023/draft-2024-isp-consultation/draft-2024-isp.pdf?la=en.

¹¹ At <https://aemo.com.au/energy-systems/electricity/national-electricity-market-nem/nem-forecasting-and-planning/system-security-planning>.

- AEMO's *Roadmap to 100% Renewables*¹², a technical base to inform industry prioritisation of steps necessary to securely, reliably and affordably transition. Section 6.14.5 has more details.
- AEMO's previous Power System Frequency Risk Reviews (PSFRRs)¹³, the predecessor to the 2023 GPSRR which focused on frequency risks.
- Transmission network service providers' (TNSPs') Transmission Annual Planning Reports (TAPRs)¹⁴.

1.2 Priority risks considered in the review

The risks studied in the 2024 GPSRR were identified through a prioritisation process in consultation with NSPs and other interested stakeholders, as well as by considering recent operational experience and power system incidents. More details on how AEMO assessed and categorised risk events can be found in the GPSRR approach paper¹⁵. AEMO identified three priority risks for consideration in the 2024 GPSRR:

- Priority risk 1: Circuit breaker failure (CBF) event in Latrobe Valley leading to trip of multiple large generating units and Basslink instability.
- Priority risk 2: Non-credible loss of the future double-circuit Humelink 500 kilovolts (kV) lines.
- Priority risk 3: Under frequency load shedding (UFLS) screening studies, including the contingencies specified in Table 9 and Table 10 (in Section 4.1.3).

Additionally, studies were completed as part of the 2024 GPSRR to determine the power transfer limits for South Australia via the Heywood interconnector and Project EnergyConnect (PEC) Stage 1 during destructive wind conditions following the commissioning of PEC Stage 1 – see Section 5.4 and Section 7.2.

The study methodology for the priority risks has been further detailed in Section 4 and the results and observations are detailed in Section 5.

1.3 Acknowledgements

AEMO acknowledges the support of many stakeholders to facilitate and inform the 2024 GPSRR, in particular:

- NSPs in supporting the study inputs, identifying priority events, and providing review comments.
- Industry consultation forum participants for their observations and insights.
- GHD for its expert assistance in completing the UFLS screening studies.

¹² At <https://aemo.com.au/initiatives/major-programs/engineering-roadmap>.

¹³ At <https://aemo.com.au/energy-systems/electricity/national-electricity-market-nem/system-operations/general-power-system-risk-review/power-system-frequency-risk-review>.

¹⁴ 2023 Transgrid TAPR, <https://www.transgrid.com.au/tapr>; 2023 Powerlink TAPR, <https://www.powerlink.com.au/planning-report/transmission-annual-planning-report-2023>; 2023 ElectraNet TAPR, <https://www.electranet.com.au/what-we-do/network/transmission-annual-planning-reports/>; 2023 TasNetworks TAPR, <https://www.tasnetworks.com.au/poles-and-wires/planning-and-upgrades/planning-our-network>; 2023 AEMO Victorian TAPR, <https://aemo.com.au/en/energy-systems/electricity/national-electricity-market-nem/nem-forecasting-and-planning/victorian-planning/victorian-annual-planning-report>.

¹⁵ At https://aemo.com.au/-/media/files/stakeholder_consultation/consultations/nem-consultations/2023/2024-gpsrr/final-document/2024-gpsrr-approach-paper---final.pdf?la=en.

1.4 Stakeholder engagement

In developing the scope and progressing the 2024 GPSRR, AEMO consulted extensively with NSPs and industry on the approach, studies, and report. Consultation steps completed and planned as at this draft report stage are listed below.

Complete

- May to July 2023: AEMO engaged with all NSPs to assist in completing risk assessments and identifying the priority risks.
- July to August 2023: Draft 2024 GPSRR approach paper provided to all NSPs and Jurisdictional System Security Coordinators (JSSCs) for review.
- August 2023: 2024 GPSRR approach paper published for industry consultation.
- September 2023: Industry briefing session on the 2024 GPSRR approach paper.
- November 2023: Final 2024 GPSRR approach paper¹⁶ published together with written submissions and consultation report¹⁷.
- April 2024: Presentation of priority risk studies results to all NSPs for their feedback.
- May 2024: Draft of this report shared with NSPs and JSSCs for their feedback.

Planned

- Until 14 June 2024: Draft report published to allow for stakeholder feedback and submissions¹⁸.
- 7 June 2024: Industry question and answer session on the draft GPSRR. Please email gpsrr@aemo.com.au for a calendar invitation.
- By 31 July 2024: Publication of final 2024 GPSRR report.

AEMO is now seeking feedback on this draft report from all registered participants interested in the GPSRR. In particular, AEMO invites feedback regarding the methodology, findings and recommendations. Submissions will contribute to the finalisation of the 2024 GPSRR report.

If you would like to provide feedback, please email it to gpsrr@aemo.com.au. Submissions will be accepted until 5.00 pm (AEST) 14 June 2024.

¹⁶ At https://aemo.com.au/-/media/files/stakeholder_consultation/consultations/nem-consultations/2023/2024-gpsrr/final-document/2024-gpsrr-approach-paper---final.pdf?la=en.

¹⁷ The 2024 GPSRR approach consultation report at https://aemo.com.au/-/media/files/stakeholder_consultation/consultations/nem-consultations/2023/2024-gpsrr/final-document/2024-gpsrr-approach-consultation-report.pdf?la=en sets out AEMO's conclusions in response to submissions received on the approach paper and reasons for updating the approach after considering those submissions.

¹⁸ There is no NER requirement for AEMO to consult on the GPSRR (having consulted on, and considered submissions in relation to, the approach paper).

Relevant submissions will be published on AEMO's website, subject to AEMO's consultation submission guidelines¹⁹. Please indicate to AEMO if there are any parts of your submission you would like kept confidential, with reasons why.

1.5 Risk management in the NEM

1.5.1 Power system security

Non-credible contingency events, by definition, are not considered reasonably possible during normal power system operation²⁰, and AEMO is not required to account for them in its real-time management of the power system. Various safeguards exist to respond to non-credible contingency events should they occur and reduce their impact on the power system. Key safeguards are:

- EFCs:
 - UFLS schemes – trip blocks of load to restore the supply demand balance.
 - Over frequency generation shedding (OFGS) schemes – trip blocks of generation to restore the supply demand balance.
- Remedial action schemes (RASs) for particular contingency events – can trip or runback generation, trip load or transmission equipment or initiate other actions to mitigate the impact of power system events.
- Generating system performance capabilities, such as fault ride-through capabilities and frequency controls.
- Other protection systems.

1.5.2 AEMO's risk management methodology

To effectively identify and manage risks associated with operating the power system, AEMO applies the principles of the AS/ISO 31000 risk management framework, undertakes root-cause analysis for major power system events, and has adopted the BowTie methodology. The GPSRR is not intended to incorporate all risks or treatments, instead focusing on priority risks that may lead to cascading outages or major supply disruptions.

1.5.3 Evolution of the risk review

From 2023, the GPSRR replaced and expanded on the scope of the previous biennial PSFRR. The risks that can be assessed in the GPSRR are no longer limited to non-credible contingency events and can involve cascading outages from causes other than uncontrolled changes in frequency. The risks studied for the GPSRR are identified through a prioritisation process in consultation with NSPs and other interested stakeholders, as well as by considering recent operational experience and power system incidents.

¹⁹ At https://aemo.com.au/-/media/files/stakeholder_consultation/working_groups/industry_meeting_schedule/aemo-consultation-submission-guidelines---march-2023.pdf?la=en.

²⁰ A non-credible contingency can also occur when a credible event causes or leads to a further unexpected event, which by definition is then considered non-credible.

AEMO has made key improvements to the modelling of power system risks since the initial PSFRR in 2017 – refer to Section 1.5.3 of the 2023 GPSRR for more details. The 2024 GPSRR makes the following further improvements and enhancements:

- Use of benchmarked future simplified NEM network model with PEC Stage 2 included for UFLS studies.
- Use of Operations and Planning Data Management System (OPDMS) full NEM models modified to include future augmentations and anticipated generation for future studies.
- Use of AEMO the four state NEM Power System Computer Aided Design (PSCAD™) version 5 model for assessment of risks impacting voltage stability and system strength.

To validate the accuracy of the models used for the 2024 GPSRR studies, the model responses were benchmarked against several real power system event measurements (see the 2023 GPSRR²¹, and the 2022 and 2020 PSFRRs for benchmarking results²²).

²¹ See <https://aemo.com.au/en/energy-systems/electricity/national-electricity-market-nem/system-operations/general-power-system-risk-review>

²² See <https://aemo.com.au/energy-systems/electricity/national-electricity-market-nem/system-operations/general-power-system-risk-review/power-system-frequency-risk-review>.

2 Industry in transition

2.1 Generation mix

Australia’s electricity needs are changing rapidly, with significant installation of inverter-based variable renewable energy (VRE) generation and faster than expected retirement of coal-fired generation. The Draft 2024 ISP suggests that the remaining coal-fired generators will close two to three times faster than announced retirement dates, which will require a seven-fold increase in large-scale wind and solar generation by 2050. This change in generation mix is outlined in Figure 1, which shows anticipated changes to generation and load composition as described in AEMO’s Draft 2024 ISP *Step Change* scenario²³.

Figure 1 Forecast NEM capacity to 2050, 2024 ISP Step Change scenario

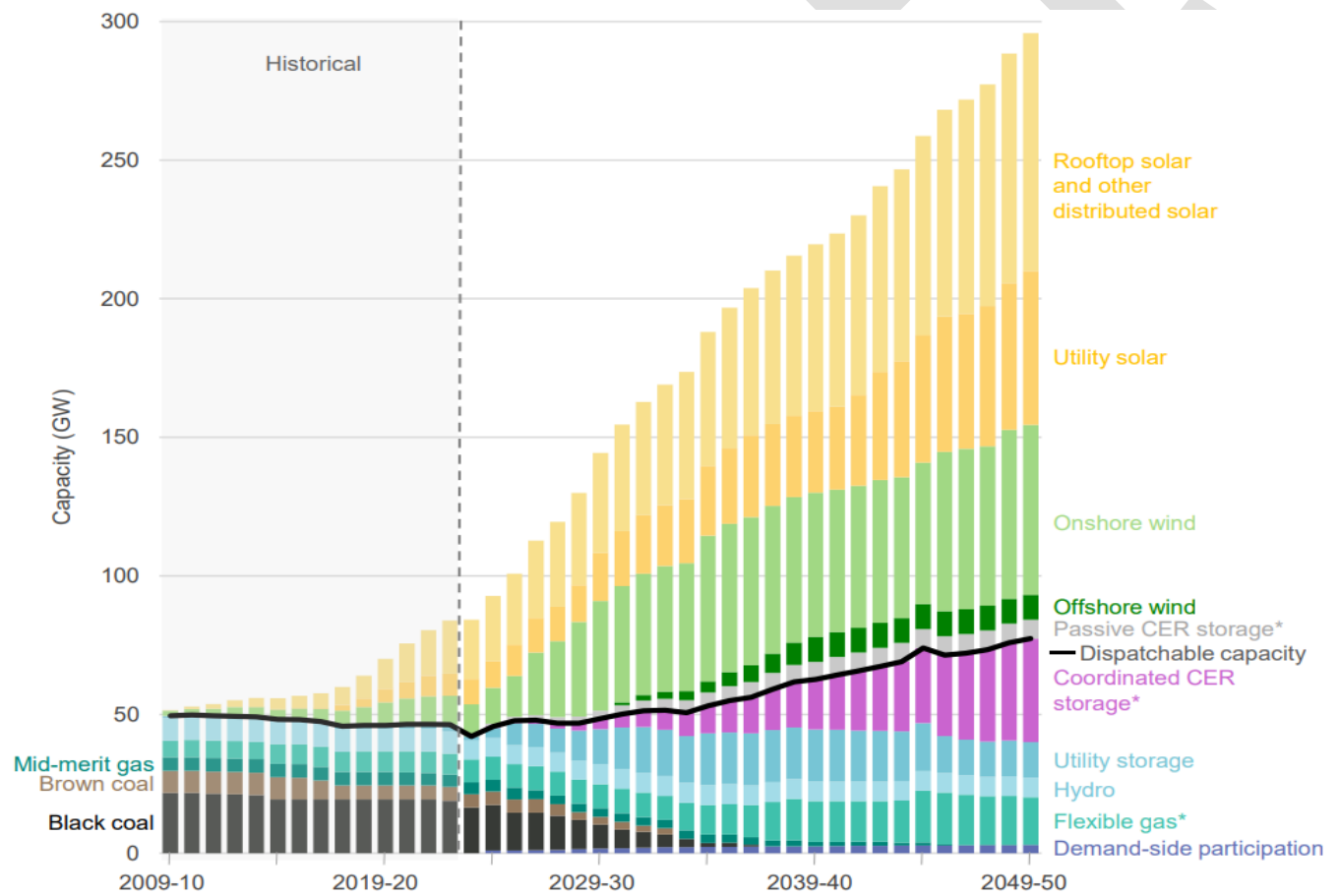

Notes: Flexible gas includes gas-powered generation, and potential hydrogen and biomass capacity. "CER storage" are consumer energy resources such as batteries and electric vehicles.

From https://aemo.com.au/-/media/files/stakeholder_consultation/consultations/nem-consultations/2023/draft-2024-isp-consultation/draft-2024-isp.pdf?la=en.

²³ The 2022 ISP *Step Change* forecast data were used to set up future study cases (see Section 4.1), therefore closures of power stations such as Liddell Power Station (2022 and 2023) and announced potential closure of Eraring Power Station (2025) have been included in the modelling considered in future studies. Note that the future dispatch scenarios selected were reviewed based on the latest ISP information available following the publication of the Draft 2024 ISP.

2.1.1 South Australia minimum synchronous generator requirements

Currently, there are operational requirements for a minimum number of synchronous generating units to remain online in the South Australia power system to maintain system security. With the operationalisation of the four ElectraNet synchronous condensers, two at Davenport and two at Robertstown, there is sufficient system strength to support up to 2,500 MW of IBR generation when South Australia is interconnected to the rest of the NEM and two large synchronous generating units are online in South Australia. South Australia has been operated in this manner since 2021, however, AEMO and ElectraNet have since undertaken a program of work to reassess the need for this minimum synchronous unit requirement given changing network conditions.

South Australia island grid reference

The 2018 ISP assumptions noted that some synchronous generation (at least one unit) could be needed for grid formation (following a separation of South Australia from the rest of the NEM) after installation of the South Australia synchronous condensers but before PEC Stage 2 is commissioned. Subsequent AEMO studies identified in theory that the four synchronous condensers and appropriate BESS can provide adequate grid reference in South Australia²⁴. Consultation with national and international organisations supported AEMO findings. To be confident that power system security can be maintained in the absence of synchronous generation, AEMO will be seeking additional evidence of successful operation, such as appropriately scaled system testing.

South Australia voltage control

In the 2023 NSCAS report²⁵, AEMO declared an NSCAS gap for voltage control in South Australia. This was based on the latest limits advice from ElectraNet and clarified a need to maintain synchronous generating units online for voltage control. ElectraNet is progressing a voltage control regulatory investment test for transmission (RIT-T)²⁶ to ensure sufficient voltage control capability is provided in the Adelaide Metropolitan region, which is expected to close this voltage control gap and subsequently allow operation with fewer synchronous generating units online.

A number of system conditions are to be met for allowing a minimum of one large 275 kV synchronous generator operation:

- Appropriate fast start unit options available to meet N-1 and N-1-1 requirements.
- Operational demand will need to be in excess of 600 MW.
- The network must be in a normal operating state, that is, not at risk of islanding, no abnormal operating conditions, and not in an island state.
- Sufficient reactive power control devices are online in the Metro area.

AEMO is currently continuing work to enable operation with fewer synchronous generating units online in South Australia, considering these system requirements.

²⁴ See https://aemo.com.au/-/media/files/electricity/nem/security_and_reliability/congestion-information/sa-transition-to-fewer-synch-gen-grid-reference.pdf.

²⁵ See https://aemo.com.au/-/media/files/electricity/nem/security_and_reliability/system-strength-requirements/2023-nscas-report.pdf?la=en.

²⁶ See <https://www.electranet.com.au/wp-content/uploads/ritt/PSCR-EC.11645-Transmission-Network-Voltage-Control.pdf>.

2.2 Distributed energy resources (DER)

DER²⁷ are a significant component of the power system, with DPV now supplying up to 51.3% of underlying demand in the NEM mainland²⁸ in some periods during 2023. In South Australia, DPV has already supplied up to 101.7% of underlying demand in some periods. It is therefore essential that AEMO and NSPs consider DER in all aspects of power system planning, including the assessment of credible and non-credible contingencies and the risks assessed in the GPSRR. AEMO has considered DER as part of the 2024 GPSRR studies (see Appendix A4 for dynamic modelling of DER).

2.2.1 DER compliance with technical settings

AS/NZS4777.2:2020 is a mandatory standard for small-scale inverters which incorporates changes aimed at improving disturbance ride-through capabilities to minimise system security risks identified by AEMO²⁹. However, AEMO has previously identified that compliance with technical settings was poor, with a wide range of data sources consistently indicating that less than half of systems installed set correctly to the required standard. With poor compliance, DER installed with undesirable disturbance ride-through capabilities will lead to increased contingency sizes in the NEM associated with DPV unintended disconnection or “shake-off” in response to disturbances.

AEMO has highlighted the scale and urgency of this issue in a report on *Compliance of Distributed Energy Resources with Technical Settings*³⁰. The report notes that while the impacts of non-compliance are complex and multifaceted, this issue is already leading to considerable challenges that will continue to worsen until DER compliance is addressed. AEMO notes that some of the DER-related system challenges and impacts are approaching intractability. Poor disturbance ride-through of DER was identified as the most serious and urgent barrier to achieving successful, secure and reliable operation of the NEM and Western Australia’s Wholesale Electricity Market (WEM) with high levels of DER.

AEMO has been investigating possible actions with relevant stakeholders to improve compliance rates of DER. Thirteen of Australia’s largest DPV original equipment manufacturers (OEMs) have provided data for recent installations to survey compliance for any improvements. The latest analysis shows that compliance has significantly improved³¹. Early in 2022, compliance with the latest standard was sitting at 40%, and it rose to 75–80% in early 2023. In Q1 2023, 21% of inverters continued to be incorrectly installed according to the 2015 standard, and 4% based on international grid codes.

AEMO continues to recommend a target of at least 90% compliance of new installations with AS/NZS4777.2:2020 beyond 2023 is urgently achieved. AEMO also recommends that improvements are made to the relevant governance frameworks to maintain and further improve that level of compliance. Specific actions that could

²⁷ Also referred to as consumer energy resources (CER).

²⁸ The NEM mainland refers to the synchronously connected regions of Queensland, New South Wales, Victoria and South Australia.

²⁹ AEMO (May 2021) *Behaviour of distributed resources during power system disturbances*, <https://aemo.com.au/-/media/files/initiatives/der/2021/capstone-report.pdf?la=en&hash=BF184AC51804652E268B3117EC12327A>.

³⁰ AEMO (April 2023) *Compliance of Distributed Energy Resources with Technical Settings*, <https://aemo.com.au/initiatives/major-programs/nem-distributed-energy-resources-der-program/standards-and-connections/compliance-of-der-with-technical-settings>.

³¹ AEMO (December 2023) *Compliance of Distributed Energy Resources with Technical Settings: Update*, https://aemo.com.au/-/media/files/initiatives/der/2023/oem_compliance_report_2023.pdf?la=en&hash=E6BEA93263DE58C64FCC957405808CA6.

contribute to achieving this target are proposed in the *Compliance of Distributed Energy Resources with Technical Settings* report³⁰, for industry consideration.

Additionally, as part of its review into consumer energy resources (CER) technical standards, on 21 September 2023 the Australian Energy Market Commission (AEMC) made final recommendations to improve compliance with technical standards for CER. In the short term, the AEMC recommended 10 immediate actions that seek to increase future and existing compliance with CER technical standards³². The AEMC also recommended that jurisdictions and energy market bodies work together to explore the options and viability of reforming the regulation of current and future CER technical standards from a national perspective.

Draft

³² See <https://www.aemc.gov.au/market-reviews-advice/review-consumer-energy-resources-technical-standards>.

3 Review of incidents

AEMO reviews power system incidents of significance in accordance with NER 4.8.15, referred to as reviewable operating incidents.

Table 3 summarises the key criteria AEMO uses to identify whether an incident is reviewable, and categories used to determine the reporting approach (preliminary and final report for major incidents, or final report only). Consistent with the Reliability Panel's guidelines for identifying reviewable incidents³³, AEMO may also undertake a review of any other events considered to be of significance.

Table 3 Reviewable incidents criteria

Category	Description	Network	Security	Frequency	Voltage	Loss of load/generation
Not reviewable	Credible event or non-credible event that does not impact critical transmission element	Credible contingency	Insecure for < 30 mins	Within Frequency Operating Standard (FOS) requirements	Within standards	No load shedding (other than disconnections/load shake-off) No loss of generation due to operation of over frequency protection
			Non-satisfactory for < 5 mins			
Reviewable	Noteworthy event requiring AEMO to prepare a report (or AEMO chooses to review an event or systemic issue)	Non-credible contingency or multiple contingency	Insecure > 30 mins	Frequency outside 49-51 Hz (mainland) or 48-52 Hz (Tas)	Minor voltage impacts within standards	No automatic or manually initiated load shedding Loss of generation due to operation of over frequency protection
Reviewable (Major)	Significant event requiring AEMO to prepare a report, impacting stakeholder confidence or adverse media exposure	Non-credible or multiple contingency resulting in separation between regions	Non-satisfactory > 5 mins		Voltage collapse resulting in local/widespread transmission black system	Automatic UFLS action or AEMO directed load shedding (other than as contracted)

³³ At <https://www.aemc.gov.au/sites/default/files/2022-09/Final%20guidelines.pdf>.

For an incident to be reviewable, it must be a noteworthy or significant event on the power system and generally include an impact to power system security, frequency, voltage or result in load disconnection/loss. Based on its experience reviewing power system incidents, AEMO has observed that unexpected power system responses are often identified during power system incidents. These often increase an event's overall severity; examples of such unexpected responses are:

- Protection mal-operation.
- Unexpected load disconnection.
- Issues with DPV fault ride-through performance.
- Issues with generator fault ride-through performance.
- Issues with fault ride-through of major loads.

3.1 Summary of reviewable operating incidents in 2023-24

To date in financial year 2023-24:

- There have been 24 reviewable incidents including two major incidents.
- There has been an increase in transmission equipment failures, including a 500 kV tower failures event, seven current transformer (CT) failures and two CB failures.

Details of these reviewable operating incidents can be found in the published incident reports, which are available on AEMO's website once AEMO's review of each incident is concluded³⁴.

Figure 2 shows the root causes of incidents in 2023-24 to date, and compared to 2022-23.

Figure 2 Root cause of reviewable operating incidents

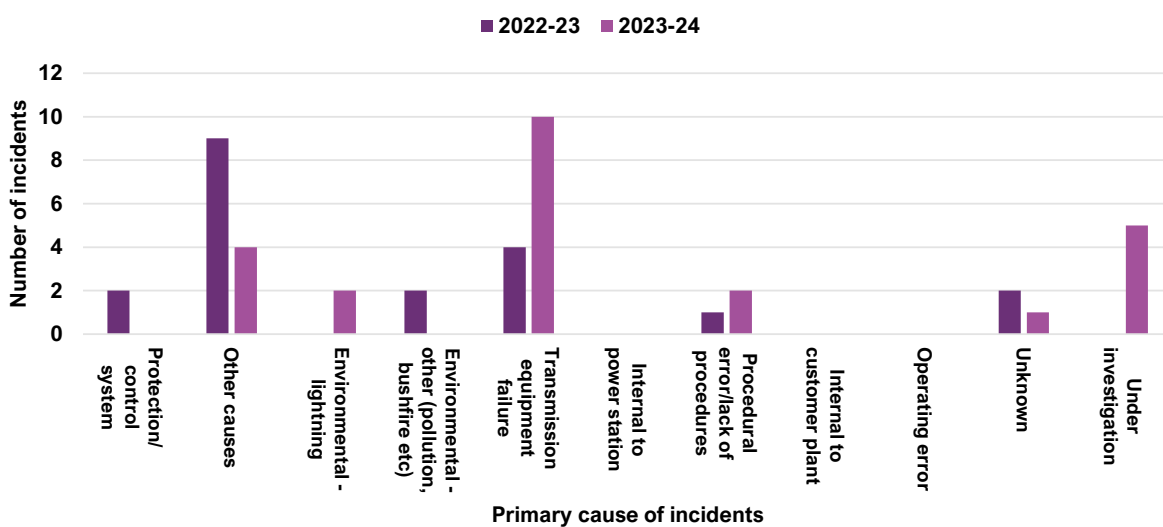

³⁴ See <https://www.aemo.com.au/energy-systems/electricity/national-electricity-market-nem/nem-events-and-reports/power-system-operatingincident-reports>.

3.2 Relevant recent incidents

3.2.1 Loss of supervisory control and data acquisition (SCADA) and line protection at Keilor Terminal Station on 29 June 2023

At 1452 hrs on 29 June 2023, a bird's nest on a transmission tower close to Keilor Terminal Station (KTS) caused a trip and successful auto-reclosure of the Altona Terminal Station (ATS) – KTS 220 kV line³⁵.

Co-incident with this fault, the KTS 48 V direct current (DC) supplies to the A and B communications incoming miniature circuit breakers (MCBs) tripped. This removed all DC supplies to the KTS communications equipment and caused the loss of all communications systems from KTS. The loss of communications at KTS interrupted SCADA to AEMO and AusNet, and interrupted communications between KTS and its connecting 220 kV and 66 kV substations. The communications disruption also resulted in the widespread loss of line differential protection and CBF signalling at KTS.

During AEMO's post-incident investigation, it was identified that the following lines had inoperable primary, backup CBF protection systems and no active supplementary³⁶ protection for a period of approximately 105 minutes:

- ATS – KTS 220 kV line.
- Brooklyn Terminal Station (BLTS) – KTS 220 kV line.
- KTS – Thomastown Terminal Station (TTS) 220 kV No. 1 line.
- KTS – TTS 220 kV No. 2 line.
- KTS – West Melbourne Terminal Station (WMTS) 220 kV No. 1 line.
- KTS – WMTS 220 kV No. 2 line.³⁷

Following the incident, AusNet installed supplementary protection on these six lines between 16 September 2024 and 24 September 2024. During the incident, other 220 kV lines³⁸ and 66 kV lines remained in service with partial or slower operable protection.

Due to the impact this incident had on primary and CBF protection systems, AEMO has determined that the power system was not in a secure operating state for approximately 105 minutes.

This incident and the trip of multiple generators and lines in Central Queensland and associated under frequency load shedding on 25 May 2021³⁹ reinforce the critical role DC systems play in maintaining operational power system protection and SCADA and in the prevention of cascading power system failures. It is therefore imperative that all participants ensure that their protection and SCADA DC systems have adequate redundancy at all times

³⁵ For full details, see the published incident report at https://aemo.com.au/-/media/files/electricity/nem/market_notices_and_events/power_system_incident_reports/2023/loss-of-scada-and-line-protection-at-keilor-terminal-station-on-29-june-2023.pdf?la=en.

³⁶ Supplementary protection functions, enabled in line current differential protection relays, act in conjunction with the primary protection function in the event the current differential protection function becomes inoperable, for example due to the loss of communications signalling.

³⁷ The KTS – WMTS 220 kV No. 2 line was out of service for a planned outage at the time of the incident.

³⁸ Deer Park Terminal Station (DPTS) – KTS 220 kV line, GTS – KTS 220 kV No. 1 line and GTS – KTS 220 kV No. 3 line.

³⁹ For full details, see the published incident report at https://aemo.com.au/-/media/files/electricity/nem/market_notices_and_events/power_system_incident_reports/2021/final-report-trip-of-multiple-generators-and-lines-in-qld-and-under-frequency-load-shedding.pdf?la=en.

(when their equipment is in service) and that they promptly take appropriate action (including informing AEMO promptly) should redundancy or protection/SCADA DC supplies be lost.

3.2.2 Multiple incidents impacting NEM SCADA between 24 January 2021 and 18 November 2023

Given the significant impact SCADA incidents have on power system operation and security, AEMO completed an investigation of 18 SCADA incidents that occurred in the NEM between 24 January 2021 and 18 November 2023 and published a reviewable operating incident report⁴⁰ in accordance with NER 4.8.15(c).

To support AEMO's investigation of the SCADA incidents, AEMO also reviewed the SCADA systems of NSPs in both the NEM and WEM, benchmarking processes, resilience and supporting capabilities against industry best practice. The findings and recommendations were informed by engagement with NEM and WEM NSPs and international system operators and input from AEMO's expert consultant, Power Systems Consultants (PSC).

Through this investigation, AEMO identified the primary contributors to SCADA incidents and impacts as:

- Processes, controls, training, and monitoring (Processes).
- Response to incidents (Response).
- Incident reporting and follow up investigation (Investigation).
- Resilience and capabilities (Resilience).

AEMO considers that the recent trend of an increasing number and growing impact of SCADA incidents poses a significant and unacceptable risk to power system operations, and therefore made eight key recommendations to address the most significant risks identified during the investigation. Focused effort is required from AEMO, NSPs and participants to promptly act on these recommendations and significantly enhance overall SCADA system reliability and resilience. Full details of the recommendations are in the published incident report. In summary:

- AEMO will establish a SCADA working group with NEM and WEM NSP members. This working group will be tasked with improving SCADA system resilience and reliability across the NEM and WEM.
- AEMO, in consultation with NSPs, will establish a standardised process for the notification of planned works on NSP and AEMO SCADA systems. To support this process, AEMO plans to create a set of guidelines which outline when and how NSPs and participants should notify AEMO of higher risk planned SCADA work.
- NSPs and AEMO to review existing automated backup and failover system testing procedures and identify opportunities for improvements.
- AEMO and NSPs to complete a review of existing SCADA monitoring tools to ensure they are able to promptly identify "downtime" of SCADA services to AEMO. The monitoring should occur in real time and allow tracking of trends in historical data. AEMO and NSPs should also investigate and, wherever feasible, implement multiple and overlapping Energy Management System (EMS)/SCADA System monitoring capabilities.

⁴⁰ AEMO (March 2024) *Multiple incidents impacting NEM SCADA between 24 January 2021 and 18 November 2023*, https://aemo.com.au/-/media/files/electricity/nem/market_notices_and_events/power_system_incident_reports/2023/multiple-incidents-impacting-nem-scada-between-2021-and-2023.pdf?la=en.

- AEMO will address the lack of familiarity with the Power System Data Communications standard and its requirements among NSPs via the SCADA working group and through the preparation and distribution of training material.
- AEMO and the TNSPs, distribution network service providers (DNSPs) and participants from which AEMO receives SCADA data should review their telecommunications systems and consider implementing changes (as required) to allow each entity to have a reliable, independent means of communication with AEMO in the event of a major network outage at their respective sites.
- AEMO to:
 - Investigate the communications connections between its New South Wales control room and Transgrid’s network to provide alternative communication links for New South Wales region data.
 - Investigate the communications connections between its Queensland control room and Energy Queensland’s network and onto Powerlink to provide alternative communication links for Queensland region data.

3.2.3 Trip of Robertstown – Tungkillo 275 kV No. 1 line and the Robertstown No. 1 and No. 2 synchronous condensers on 28 November 2023

Lightning during a storm caused two simultaneous single-phase faults on the Robertstown – Tungkillo 275 kV No. 1 and No. 2 lines. A ‘W’ phase⁴¹ to earth fault occurred on Robertstown – Tungkillo 275 kV No. 1 line and a ‘U’ phase to earth fault occurred on Robertstown – Tungkillo 275 kV No. 2 line. At 0534 hrs on 28 November 2023, all three poles of the corresponding CB at Tungkillo end of the Robertstown – Tungkillo 275 kV No. 1 line tripped and remained locked out, as the two simultaneous faults occurred on two different phases and they were within the Zone 2 reach of the distance protection used at Tungkillo. The single-phase to earth fault in ‘U’ phase of the Robertstown – Tungkillo 275 kV No. 2 line led to the tripping and auto reclosing of the faulted pole of the corresponding CBs at both ends of the Robertstown – Tungkillo 275 kV No. 2 line. At 0536 hrs, Robertstown No. 1 and No. 2 synchronous condensers (SCs) tripped, due to flywheel housing vacuum pump drive failure. The close-in simultaneous faults on Robertstown – Tungkillo 275 kV No. 1 and No. 2 lines caused a large voltage dip resulting in the vacuum pump drives signalling a ‘Drive Failed’ latching event, which had to be manually reset before the vacuum pumps could be returned to service. At 0546 hrs, ElectraNet System Control closed the corresponding CBs at Tungkillo to restore the Robertstown – Tungkillo 275 kV No. 1 line. The Robertstown No. 1 and No. 2 SCs were returned to service at 1102 hrs and 1402 hrs, respectively.

ElectraNet’s design/build contractor of the Robertstown No. 1 and No. 2 SCs added an automatic restart capability to both SCs on 14 February 2024 to improve their ride-through capability.

The power system remained in a secure operating state throughout this incident and the Frequency Operating Standard (FOS)⁴² was met for this incident. At no point during this incident were transmission system voltages outside of relevant voltage limits defined in the NER, or as specified by NSPs in their limits advice to AEMO.

⁴¹ U-V-W phase sequences are equivalent to A-B-C, R-W-B, or R-Y-B phase sequence. U-V-W are used to denote the phases of 275 kV lines.

⁴² Effective 1 January 2020, at <https://www.aemc.gov.au/media/87484>.

The simultaneous tripping of multiple large SCs could have a severe impact on system security when the South Australia system is operated with fewer synchronous generating units (as discussed in Section 2.1.1). Therefore, this incident demonstrates the importance of ensuring the risk of inadvertent trips of SCs is appropriately considered in line with their performance requirements and minimised in the SC design phase. Further, it is imperative to ensure that sufficient redundancy is installed in all SCs and a full audit of protection settings including auxiliary systems is carried out to enable high reliability and uninterrupted operation.

3.2.4 Trip of Moorabool – Sydenham 500 kV No. 1 and No. 2 lines on 13 February 2024

At 1308 hrs on 13 February 2024, the Moorabool (MLTS) – Sydenham (SYTS) No. 1 and 2 500 kV lines tripped following failure of six 500 kV towers (three on each of the two 500 kV circuits). The simultaneous trip of these 500 kV lines and subsequent disconnection of all four Loy Yang A generating units, Dundonnell Wind Farm and Yaloak South Wind Farm had a significant impact on the Victorian power system. Initial review indicates Dundonnell Wind Farm tripped as designed due to operation of the South West 500 kV special control scheme. In total, approximately 2,690 MW of generation was lost, and 1,000 MW of load was shaken off⁴³ in Victoria following the disturbance.

Following the event, at 1420 hrs on 13 February 2024, AEMO instructed AusNet⁴⁴ to shed 300 MW of load to manage loading of in-service network elements. AEMO subsequently instructed load to be restored in two stages, at 1450 hrs and 1510 hrs.

Later, at 1543 hrs on 13 February 2024, a separate incident occurred involving trip of the Hazelwood Terminal Station (HWTS) – Jeeralang Terminal Station (JLTS) 220 kV No. 2 line and the offloading of the HWTS 500/220 kV No. 1, No. 2, No. 3 and No. 4 transformers. This incident will be subject to a separate review.

Separate to the transmission system event, storm activity across Victoria caused significant damage to the distribution networks on Tuesday 13 February 2024, impacting more than 500,000 residential and business customers.

Given the significance of this event, AEMO has prepared a preliminary report⁴⁵ for the industry covering the period from the initial event at 1308 hrs until 1515 hrs on 13 February 2024. The preliminary report is based on the known facts as at 15 February 2024, and does not attempt to provide any analysis or recommendations. The final report on this incident is expected to be published in Q3 2024.

⁴³ Load shake-off refers to generalised disconnection of load in response to unusual network conditions during a disturbance, such as a deep voltage dip or phase angle jump.

⁴⁴ AusNet is the Victorian Declared Transmission System Network Operator.

⁴⁵ At https://aemo.com.au/-/media/files/electricity/nem/market_notices_and_events/power_system_incident_reports/2024/preliminary-report---loss-of-moorabool---sydenham-500-kv-lines-on-13-feb-2024.pdf?la=en.

4 Study methodology

4.1 Study overview

This section describes the assessment approach for historical and future study cases. AEMO published the proposed methodologies for the selected priority risks for industry consultation in the 2024 GPSRR approach paper – refer to the final approach paper for more details on the modelling approach⁴⁶. Consistent with the 2023 GPSRR modelling approach, a combination of a Power System Simulation for Engineering (PSS®E) simplified NEM network model, a PSS®E full NEM network model and a Power System Computer Aided Design (PSCAD™) wide-area/four-state model was used to assess the priority risks identified for the 2024 GPSRR. Details of network, dynamics, special protection schemes (SPS), DPV, UFLS and OFGS models used for the studies are in Appendix A4.

4.1.1 Priority risk 1: CBF event in Latrobe Valley leading to trip of multiple large generating units and Basslink instability

As part of the 2024 GPSRR, the risk of a non-credible event that could lead to cascading failure due to low system strength was assessed. These studies involved the assessment of a fault on the Loy Yang B unit 2 transformer followed by the failure of the single bus coupler circuit breaker (CB) that connects the 500 kV No. 3 bus and Loy Yang B unit 2. This would result in the CBF protection clearing the No. 3 bus, disconnecting both Loy Yang B units as well as Valley Power Station. This could result in the loss of up to approximately 1,300 MW of generation in Victoria. A simplified single line diagram of the Loy Yang power station and the relevant CBs is shown in Figure 3 below.

Additionally, from operational experience and past study results, such significant contingencies are often followed by unexpected events such as generators tripping due to ride-through issues, DPV shake-off, and/or interconnector trip leading to separation of regions.

As part of the 2023 GPSRR, studies of this contingency were completed using a simplified NEM model to assess the impact on QNI. The results showed that the QNI could become unstable and lead to Queensland separating from the rest of the NEM following this contingency during high flow conditions into New South Wales⁴⁷. Furthermore, the disconnection of Loy Yang A units following the tower failure incident in Victoria on 13 February 2024⁴⁸ (refer to Section 3.2.3) shows that severe non-credible contingency events often result in additional unexpected cascading failures that significantly increase the effective contingency size. Therefore, severe non-credible events such as this contingency studied as part of the 2024 GPSRR could lead to cascading failures of the power system.

⁴⁶ See <https://aemo.com.au/en/consultations/current-and-closed-consultations/2024-gpsrr-review>.

⁴⁷ 2023 GPSRR - https://aemo.com.au/-/media/files/stakeholder_consultation/consultations/nem-consultations/2023/draft-2023-general-power-system-risk-review/2023-gpsrr.pdf?la=en.

⁴⁸ AEMO (2024) *Preliminary Report – Trip of Moorabool – Sydenham 500 kV No. 1 and No. 2 lines on 13 February 2024* - https://aemo.com.au/-/media/files/electricity/nem/market_notices_and_events/power_system_incident_reports/2024/preliminary-report---loss-of-moorabool---sydenham-500-kv-lines-on-13-feb-2024.pdf?la=en.

Figure 3 Simplified single line diagram of Loy Yang power station – CB statuses post fault clearance

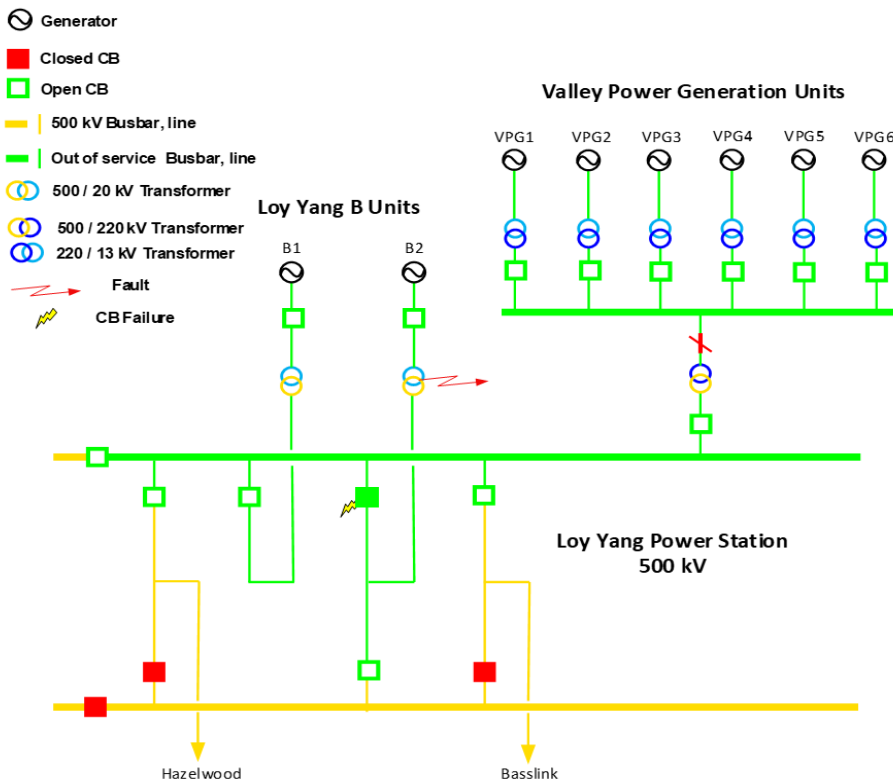

Synchronous generator combinations

As this risk is associated with low system strength conditions, combinations involving the minimum number of synchronous generators were used for all NEM regions in the PSCAD™ simulation cases. The minimum synchronous generator combinations that were used for Queensland, New South Wales, and South Australia are given in Table 4.

Table 4 The minimum synchronous generator combinations used for Queensland, New South Wales, and South Australia

Region	Power station	Number of units
Queensland	Gladstone Power Station	3
	Stanwell Power Station	3
	Callide B Power Station	1
	Millmerran Power Station	1
	Tarong Power Station	2
	Wivenhoe Power Station	1
	Kareeya Power Station	2
New South Wales ^A	Bayswater Power Station	2
	Mount Piper Power Station	2
	Vales Point Power Station	1
South Australia ^B	Torrens Island Power Station	2

A. This five-unit combination was chosen to account for the possibility that the New South Wales minimum requirement may change.
 B. In addition to the four synchronous condensers.

Two minimum synchronous generator combinations, detailed in Table 5, were considered for Victoria in this study. These combinations were selected because they include the highest number of Loy Yang and Valley Power generating units out of all the minimum synchronous generator combinations for Victoria⁴⁹. Therefore, following the contingency event, the fewest possible number of synchronous generators remain online in Victoria.

Table 5 The minimum synchronous generator combinations used for Victoria

Region	Synchronous machine combination	Power station	Number of units
Victoria	VIC_9	Loy Yang A and B power stations	3
		Valley Power station	3
		Newport power station	1
	VIC_39	Loy Yang A and B power stations	3
		Valley Power station	6

Contingency assumptions

For these studies, a two phase-to-ground (2ph-G) fault⁵⁰ was applied at the high voltage (HV) side of the Loy Yang B2 transformer, and the fault was cleared in accordance with the maximum NER⁵¹ 500 kV CBF clearance time of 175 milliseconds (ms).

Additional sensitivities were completed applying a three phase-to-ground (3ph-G) fault and reduced fault clearing times of 100 ms to assess the impact of the contingency against symmetrical faults and reduced fault clearing times.

Basslink performance

The following factors were considered to assess Basslink performance:

- DC power recovery rate.
- DC power oscillations during recovery.
- Failure to recover/trip of Basslink.
- Voltage recovery on Tasmania and Victorian ends.

Previous studies undertaken to determine the minimum fault level requirements at Hazelwood 500 kV node identified that Basslink would not trip for fault levels down to 7,700 megavolt amperes (MVA) at Hazelwood, however, did not consider the potential for commutation failure to result in a Basslink trip.

4.1.2 Priority risk 2: Non-credible loss of future double-circuit HumeLink 500 kV lines

The purpose of these studies completed as part of the 2024 GPSRR was to investigate the consequence of the non-credible loss of the future double-circuit 500 kV HumeLink lines, and the feasibility of different remedial measures, including reactive support and a RAS. Transgrid is evaluating risks associated with the non-credible

⁴⁹ Transfer Limit Advice—System Strength in SA and Victoria https://www.aemo.com.au/-/media/files/electricity/nem/security_and_reliability/congestion-information/transfer-limit-advice-system-strength.pdf.

⁵⁰ Unbalanced faults are generally onerous for IBR to ride through.

⁵¹ NER fault clearance times, at <https://energy-rules.aemc.gov.au/ner/519/352242#S5.1a.9>.

loss of HumeLink double-circuit 500 kV lines. In accordance with NER S5.1.8, Transgrid has undertaken initial studies to assess the impact on Transgrid's network and the feasibility of a RAS to manage this non-credible event. AEMO has reviewed and has provided input to this evaluation when consulted under NER S5.1.8 and has presented the results as part of this GPSRR.

HumeLink contingency

HumeLink augmentation

HumeLink is a proposed 500 kV line to reinforce the southern New South Wales network for connecting the Snowy Mountains Hydroelectric Scheme and Project EnergyConnect to Bannaby. This will provide access to increased generation and storage from Snowy Hydroelectric and renewable generation in Southern and South-west New South Wales. HumeLink will increase transfer capacity from Canberra/Yass to Bannaby by up to 2,200 MW.

HumeLink was identified as an actionable ISP project in the 2020 and 2022 ISPs and is confirmed to be an actionable ISP project in the Draft 2024 ISP. Transgrid has completed the RIT-T process for this project and early works funding has been approved by the Australian Energy Regulator (AER).

The HumeLink ISP actionable augmentation comprises:

- New Gugaa 500/330 kV substation and 330 kV double-circuit connection to the existing Wagga Wagga 330 kV substation.
- 500 kV transmission circuits between:
 - Maragle and Bannaby 500 kV substations.
 - Maragle and Gugaa 500 kV substations.
 - Gugaa and Bannaby 500 kV substations.
 - These circuits will be built on double-circuit transmission structures.
- Three 500/330 kV 1,500 MVA transformers at Maragle substation.
- Two 500/330 kV 1,500 MVA transformers at new Gugaa substation.
- 500 kV line shunt reactors at the ends of Maragle – Bannaby, Maragle– Gugaa and Gugaa – Bannaby 500 kV lines.
- Augmenting the substations at Wagga Wagga and Bannaby to accommodate the additional transmission lines and transformers.

Figure 4 shows a simplified line diagram of the HumeLink augmentation.

Figure 4 HumeLink augmentation simplified single line diagram

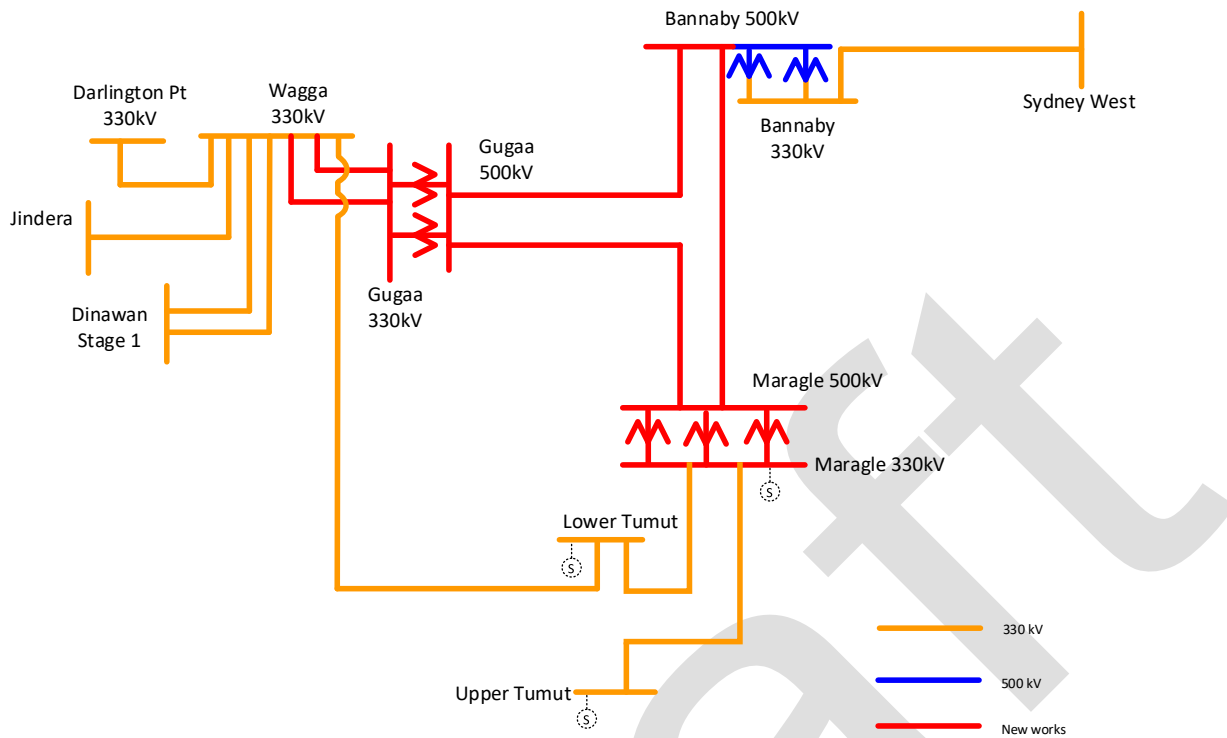

Non-credible loss of HumeLink 500 kV lines

The non-credible loss of any two of the future HumeLink 500 kV lines was studied as part of the 2024 GPSRR applying the following assumptions:

- A 2ph-G zero impedance fault was applied at the Bannaby, Maragle or Gugaa 500 kV bus.
- The non-credible loss of the future HumeLink 500 kV lines was assessed assuming the NER primary fault clearance time of 80 ms⁵².

The three contingencies that were applied for the HumeLink studies are detailed in Table 6.

Table 6 HumeLink contingencies

Contingency name	Contingency description
Bannaby	Fault at Bannaby end and loss of Bannaby – Gugaa and Bannaby – Maragle lines.
Gugaa	Fault at Gugaa end and loss of Bannaby – Gugaa and Gugaa – Maragle lines
Maragle	Fault at Maragle end and loss of Gugaa – Maragle and Bannaby – Maragle lines

Data to assess future scenarios

To assess contingencies with future network operating conditions, AEMO applied the following five-year ISP 2022 *Step Change* projection data:

- HumeLink flow (high in the northerly and southerly directions).

⁵² See Table S5.1a.2 in NER Chapter 5.

- Regional load (high and low).
- Regional inertia (high and low).
- DER generation (high and low).
- PEC Stage 2 + Heywood flows (high into Victoria, high into South Australia).
- Victoria – New South Wales Interconnector (VNI) flow (high into New South Wales, high into Victoria)
- QNI flow (high in the northerly and southerly directions).

Future dispatch selection

AEMO developed a standard set of six future dispatches, and these were studied for the non-credible HumeLink contingencies – four with high northerly HumeLink flows and two with high southerly flows. Table 7 shows the overview of selected timestamps for future dispatch with key network conditions and their levels.

Transgrid developed a further set of six future dispatches, and these were studied for the non-credible HumeLink contingencies – four with high northerly HumeLink flows and two with high southerly flows. Table 8 shows the overview of selected timestamps for future dispatch with key network conditions and their levels.

Table 7 Key NEM parameter values of selected HumeLink future dispatches

Case	Timestamp	HumeLink flow (northerly flow +ve) (MW)	NSW op demand (MW)	QNI flow (QLD export +ve) (MW)	VNI flow (VIC export +ve) (MW)	HIC + PEC flow (SA export +ve) (MW)
1	7/06/2029 0500 hrs	2,300	8,824	-940	2,667	1,114
2	29/11/2028 1500 hrs	1,611	15,445	1,423	1,310	1,157
3	29/06/2029 1000 hrs	1,863	12,913	972	1,953	718
4	15/07/2028 2230 hrs	2,108	9,965	733	2,287	922
5	9/03/2029 0330 hrs	-1,368	6,407	106	-1,744	-1,025
6	26/08/2028 1230 hrs	-1,112	3,047	1,338	-1,732	-308

Table 8 Key NEM parameter values of Transgrid HumeLink cases

Case	HumeLink flow (northerly flow +ve) (MW)	NSW op demand (MW)	QNI flow (QLD export +ve) (MW)	VNI flow (VIC export +ve) (MW)	HIC + PEC flow (SA export +ve) (MW)
T1	2,150	13,046	500	-2,770	600
T2	2,500	13,046	500	-2,210	480
T3	1,730	8,883	640	760	1,220
T4	1,760	8,883	640	330	1,220
T5	-250	8,883	640	270	1,280
T6	-700	8,883	640	-1,760	1,240

4.1.3 Priority risk 3: UFLS screening studies

In accordance with NER 5.20A.1, as part of the 2024 GPSRR, AEMO completed UFLS screening studies for mainland NEM regions to assess the current and future performance of the existing UFLS schemes and identify any need for remediation and/or modification, considering other sources of regional emergency under frequency response (EUFR). EUFR includes the response from UFLS, as well as the frequency response from fast responding resources such as BESS and other types of IBR which can also contribute to arrest of a fast frequency decline.

Under the NER, AEMO has a number of power system security responsibilities that involve assessing the availability and adequacy of EFCS, with the objective of ensuring sufficient reserves to arrest the impacts of significant multiple contingency events, affecting up to 60% of the total power system load (NER 4.3.1(k)).

To evaluate the adequacy of UFLS and EUFR in the current and future system, the UFLS screening studies (priority risk 3) were assessed against both historical FY 2022-23 and future FY 2028-29 operating conditions using a simplified PSS®E NEM network model.

Summary of contingencies assessed for UFLS screening studies

The contingencies that were assessed in the UFLS screening studies are outlined in Table 9 and Table 10, and are consistent with those considered in previous UFLS reviews. The multiple contingency events cover a range of contingency sizes and inertia combinations across the mainland NEM based on existing generation as well as the loss of potential future renewable energy zone (REZ) generation across the NEM. For example, North American Electric Reliability Corporation's (NERC's) transmission system planning performance requirements specify that the loss of two generating stations should not result in cascading failure⁵³. Separation events were also considered as part of these screening studies. AEMO consulted on the UFLS contingencies for the 2024 GPSRR as part of the approach paper public consultation⁵⁴ in 2023.

In accordance with NER 4.3.1(k), these multiple contingency events are considered significant by AEMO, and affect up to 60% of the total power system load. AEMO has assessed the availability and adequacy of UFLS and EUFR for these contingency events for a wide range of historical and future dispatch conditions, with the objective of ensuring sufficient reserves to arrest the impacts of these significant multiple contingency events.

Unless stated otherwise, the multiple stations and/or transmission elements were tripped simultaneously for each contingency event, as this has the most severe impact on the power system frequency performance and rate of change of frequency (RoCoF).

Note that South Australia separation pre-PEC Stage 2 was not the focus of the 2024 GPSRR UFLS screening studies, because the South Australia EUFR requirement was assessed as part of a separate AEMO report⁵⁵.

⁵³ NERC, TPL-001-5 – Transmission System Planning Performance, TPL Requirements, <https://www.nerc.com/pa/Stand/Reliability%20Standards/TPL-001-5.pdf>.

⁵⁴ See https://aemo.com.au/-/media/files/stakeholder_consultation/consultations/nem-consultations/2023/2024-gpsrr/2024-gpsrr-approach-paper---for-consultation.pdf?la=en.

⁵⁵ AEMO (May 2024), *Emergency Under Frequency Response for South Australia*, <https://aemo.com.au/-/media/files/initiatives/der/2024/2024-05-21-emergency-underfrequency-requirements-for-south-australia.pdf?la=en&hash=200839621941320C557B67B6DC4DF59A>.

Table 9 Historical UFLS contingencies

Contingency no.	Approximate contingency size (MW)	Approximate contingency inertia (MWs)	Description
1	1,400	5,000	Equivalent to: Mt Piper station trip
2	2,200	9,000	Equivalent to: Loy Yang A station trip
3	3,000	12,500	Equivalent to: Loy Yang A station trip + Torrens Island Power Station (TIPS) B trip
4	3,600	12,000	Equivalent to: Eraring + Millmerran stations trip
5	4,400	17,500	Equivalent to: Loy Yang A station trip + Mt Piper station trip + TIPS B trip
6	5,200	19,500	Equivalent to: Loy Yang A station trip + TIPS B trip + Mt Piper station trip + Millmerran station trip
7	3,300	12,400	Equivalent to: Bayswater station trip + Mt Piper No.2 plant trip
8	4,350	15,800	Equivalent to: Bayswater station trip + 1 unit each from Mt Piper, Gladstone, Tarong and Loy Yang A3 plants trip
9	5,500	19,600	Equivalent to: Eraring station trip + Bayswater station trip
10	-	-	VNI separation + Loy Yang A station trip
11	-	-	QNI separation + Millmerran station trip
12	-	-	HIC separation + TIPS B + Pelican Point station trip

MWs: megawatt seconds

Table 10 Future UFLS contingencies

Contingency no.	Approximate contingency size (MW)	Approximate contingency inertia (MWs)	Description
1	900	2,300	Equivalent to: Millmerran station trip
2	1,400	5,000	Equivalent to: Mt Piper station trip
3	2,200	9,000	Equivalent to: Loy Yang A station trip
4	3,000	12,500	Equivalent to: Loy Yang A station trip + TIPS B trip
5	4,400	17,500	Equivalent to: Loy Yang A station trip + Mt Piper station trip
6	2,300	7,300	Equivalent to: Mt Piper station trip + Millmerran station trip
7	5,300	20,000	Equivalent to: Loy Yang A station trip + TIPS B trip + Mt Piper station trip + Millmerran station trip
8	6,000	14,000	Double tower contingency (4 circuits) of 6 gigawatts (GW) REZ
9	2,500	5,250	Double single tower contingency (2 circuits) of 2.5 GW REZ
10	2,000	4,000	Equivalent to: Loy Yang B station trip + Valley Power station trip + Basslink trip
11	-	-	QNI separation + Callide C station trip
12	-	-	Loss of generation = 40% of total mainland operational demand
13	-	-	Loss of generation = 60% of total mainland operational demand

Dispatch selection

The key system forecast parameters relevant to each UFLS contingency that were considered in setting up the study cases are listed below:

- Regional inertia.

- Contingency size.
- Net UFLS availability.
- DER generation.
- Regional large-scale BESS headroom.
- Interconnector flows.
- Regional operational demand.

Historical studies

To assess risks against historical operating conditions, AEMO selected historical dispatches representing operating boundaries relevant to each contingency event. A standard set of 15 historical dispatches were studied for each contingency. Appendix A4.5.8 contains an overview of selected timestamps for each scenario with key network conditions and their levels.

Future studies

A standard set of 11 future dispatches were studied for each contingency. Appendix A4.5.8 contains an overview of selected timestamps for future dispatch with key network conditions and their levels.

4.2 PEC Stage 1 destructive wind limit studies modelling approach

These studies were completed as part of the 2024 GPSRR to determine the power transfer limits for South Australia via the Heywood interconnector and PEC Stage 1 during destructive wind conditions following the commissioning of PEC Stage 1 to reduce the likelihood of South Australia islanding. The studies considered a range of large generation tripping contingencies in South Australia that could occur as a result of destructive wind conditions. This is aligned with the previous protected event declaration for the loss of multiple transmission elements causing generation disconnection in the South Australia region during forecast destructive wind conditions⁵⁶. Note that there are other more severe multiple/non-credible contingency events that could still cause South Australia separation that were not included in the scope of these studies.

4.2.1 Background

On 5 November 2018, AEMO submitted a request to the Reliability Panel seeking the declaration of a protected event to assist AEMO with maintaining power system security in South Australia. The request from AEMO was an outcome of the 2018 PSFRR⁵⁷. In the 2018 PSFRR, AEMO concluded that the risk of transmission faults in South Australia causing significant loss of generation may lead to a loss of the Heywood interconnector during periods where “destructive wind conditions” are forecast in the region.

⁵⁶ For the AEMC determination on the request for protected event declaration, see <https://www.aemc.gov.au/sites/default/files/2019-06/Final%20determination%20-%20AEMO%20request%20for%20declaration%20of%20protected%20event.pdf>.

⁵⁷ See https://www.aemo.com.au/-/media/files/electricity/nem/planning_and_forecasting/psfrr/2018_power_system_frequency_risk_review_final_report.pdf.

In April 2023, AEMO made a request to the Reliability Panel under clause 5.20A.5 of the NER to revoke the destructive winds protected event⁵⁸, effective from October 2023. The Reliability Panel agreed to revoke the South Australia protected event for the following reasons:

- AEMO can manage the risk of destructive winds through the revised contingency reclassification framework, which allows AEMO to reclassify the distributed loss of up to 500 MW of generation in South Australia as a credible contingency event where destructive wind conditions are forecast by the Bureau of Meteorology⁵⁹.
- Revoking the protected event will allow for operational arrangements to be revised to reflect network changes, this includes the commencement of inter-network testing of PEC Stage 1 in Q3 2024 as well as the future commencement of PEC Stage 2, planned for 2025.
- Revoking the protected event will likely avoid excessive costs from the application of constraints that excessively constrain the power system following the commencement of PEC Stage 1.

As the protected event has now been revoked, AEMO plans to review and report on the effectiveness and appropriateness of the arrangements used to manage the priority risk of destructive winds in South Australia as part of its annual GPSRR. Studies have been completed in this year's GPSRR to identify suitable South Australia destructive winds import limits, post-PEC Stage 1 commissioning, allowing for a contingency size up to 600 MW.

The previous South Australia destructive winds protected event required AEMO to take steps to actively manage the risk that, during periods of forecast destructive wind conditions in South Australia, the loss of multiple transmission elements could cause up to 500 MW of generation to disconnect in South Australia (being a contingency that is assumed to be reasonably possible when destructive winds are forecast). Presently, AEMO constrains Heywood flows to a maximum of 250 MW import to South Australia, as this allows for a 600 MW headroom up to the 850 MW satisfactory limit. At this level, a loss of 500 MW of generation in South Australia would not cause Heywood to trip (Heywood flows would increase to approximately 750 MW, but the interconnector would remain in service).

In the 2022 PSFRR⁶⁰, AEMO calculated that constraining Heywood import to 430 MW and PEC Stage 1 import to 70 MW should be sufficient to prevent either interconnector exceeding the satisfactory stability limit of 850 MW⁶¹ for the Heywood interconnector and the satisfactory thermal limit of 250 MW⁶² for PEC Stage 1 following a trip of 500 MW of South Australia generation. These limits also include 100 MW of margin split between Heywood and PEC Stage 1 to account for interconnector drift.

⁵⁸ For the AEMC determination on revoking the SA protected event, see <https://www.aemc.gov.au/sites/default/files/2023-09/REL0088%20-%20Final%20Determination%20-%20Revoking%20the%20SA%20protected%20event.pdf>.

⁵⁹ In the 2022 PSFRR, AEMO noted that it would consider whether the destructive winds protected event could be managed under the new contingency reclassification framework, effective from 9 March 2023.

⁶⁰ See https://aemo.com.au/-/media/files/stakeholder_consultation/consultations/nem-consultations/2022/psfrr/2022-final-report---power-system-frequency-risk-review.pdf?la=en.

⁶¹ Heywood satisfactory stability limit is 850 MW based on existing constraints for voltage and transient stability for the largest generation credible contingency in South Australia. In four of the five non-credible contingency events where South Australia has separated from Victoria since 1999, a sudden loss of generation (around 500 MW) in South Australia at times of high import from Victoria resulted in a rapid increase of imports before protection systems disconnected the Heywood interconnector on detected loss of synchronism between South Australia and the remainder of the NEM. While the exact tripping conditions are complex, analysis of these events in the *Black System South Australia 28 September 2016 – Final Report* suggests that the Heywood interconnector's protection will operate at approximately 900 MW, depending on system conditions. See Table 11 in https://www.aemo.com.au/-/media/files/electricity/nem/market_notices_and_events/power_system_incident_reports/2017/integrated-final-report-sa-black-system-28-september-2016.pdf?la=en&hash=7C24C97478319A0F21F7B17F470DCA65.

⁶² Based on 15-minute thermal rating of the Buronga phase shifting transformer (PST).

The studies completed as part of the 2024 GPSRR assess the existing satisfactory limits of the interconnectors to determine if instability occurs for a 500 MW contingency size for flows below these limits. Additionally, the studies included an evaluation of the ongoing suitability of a 500 MW generation contingency size for calculation of the South Australia destructive winds import limits considering the large, committed generator projects in South Australia as well as the impact of DPV shake-off. It was determined that an additional 100 MW margin should be applied to account for larger contingency sizes due to increased wind online in South Australia. As a result, a 600 MW contingency size was used to determine the destructive wind transfer limits.

4.2.2 Network model

For the PEC Stage 1 destructive wind limit studies, the AEMO full NEM PSS@E model was used, which is based on the AEMO OPDMS⁶³ model. A system normal⁶⁴ network configuration was assumed, with the Black Range series capacitors in service. The recently installed South East 275 kV 100 megavolt amperes reactive (MVar) switched capacitor banks 61 and 62 were assumed to be out of service/unavailable for switching for the purposes of these studies (these capacitor banks increase the voltage stability limit for Heywood interconnector flows from Victoria to South Australia nominally by 45 MW).

In addition, the following augmentations were included:

- Network augmentations associated with PEC Stage 1 including:
 - A double-circuit 275 kV line between Robertstown and Bunday in South Australia.
 - One circuit of the 330 kV double-circuit line from Buronga in NSW to Bunday in South Australia.
 - One 200 MVA phase shifting transformer at Buronga.
 - One 330/220 kV transformer at Buronga.
 - Three 330/275 kV transformers at Bunday.
 - Connection of Bunday to Robertstown with two 275 kV circuits.
 - Reactive plant installations at Bunday and Buronga.
- Significant committed and anticipated generation models added for South Australia as of July 2023, including:
 - Goyder Wind Farm (both Stage 1 and Stage 2).
 - Torrens Island BESS.
 - Cultana Solar Farm.

Smaller committed or anticipated wind and solar generators were not included, as it was not expected they would have a material impact on the studies conducted.

The network augmentations associated with Stage 1 of Project Energy Connect are shown in Figure 5.

⁶³ The OPDMS is a software system that supports the planning and operations functions in an electricity market environment.

⁶⁴ System normal snapshots restore the nominal configuration of the network. Network outages (planned or unplanned) are restored to the nominal configuration while generation and load are retained as they were in the snapshot timestamp. In the future studies the load and generation will be redispatched, and network projects will be added to match the forecast network conditions.

Figure 5 Project Energy Connect Stage 1 single line diagram

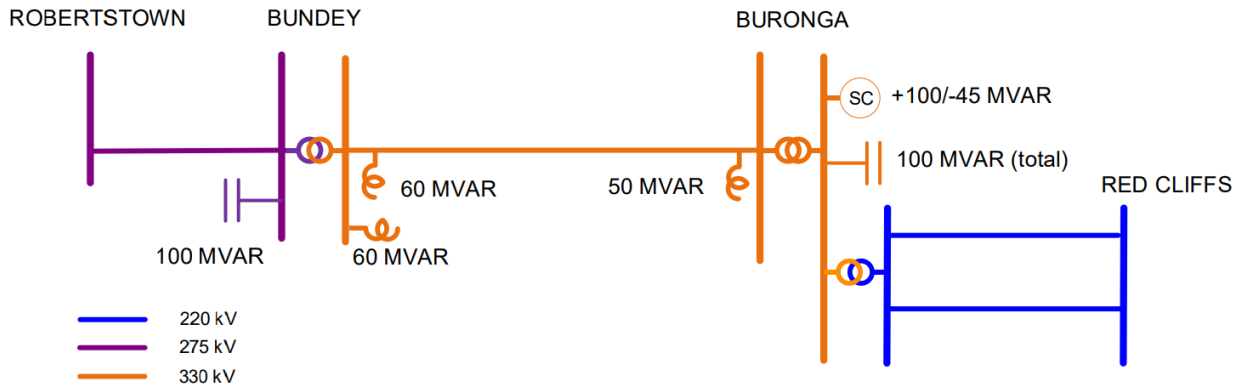

The PEC Stage 1 interconnector will operate in parallel with the existing Heywood and Murraylink interconnectors and will provide an additional 150 MW of interconnector capacity for both South Australia import and export. At the completion of PEC Stage 2, PEC capacity is expected to increase up to 800 MW for South Australia import and export. In addition, it is also expected that internetwork testing will be completed on the Heywood interconnector to release the full capacity of 650 MW for South Australia import and export. The expected South Australia alternating current (AC) interconnector capacities after each stage of PEC are shown in Table 11.

Table 11 SA AC interconnector capacities, post PEC commissioning

PEC Stage	HIC capacity (MW)	PEC capacity (MW)	Combined capacity (MW)
1	650 SA Import 650 SA Export	150 SA Import 150 SA Export	750 SA Import 700 SA Export
2	650 SA Import 650 SA Export	800 SA Import 800 SA Export	1300 SA Import 1450 SA Export

4.2.3 Wide Area Protection Scheme

For determination of the PEC Stage 1 destructive wind limits, scenarios where the wide area protection scheme (WAPS) was considered to be out of service or ineffective were studied. This was done to align with the approach taken in determining the original 250 MW limit for the Heywood interconnector during destructive wind conditions where the operation of the System Integrity Protection Scheme (SIPS) was not considered. In AEMO’s request for the protected event declaration, it was stated that relying solely on the existing SIPS was not acceptable due to the following reasons:

- SIPS was shown to manage generation loss events up to approximately 500 MW in size, under system normal conditions only.
- During destructive wind conditions where damage and tripping of transmission lines is more likely, the transient limits on the transmission network are expected to be lower.
- During destructive wind conditions, physical damage can impact both communications equipment and transmission infrastructure, meaning that a robust solution will reduce the risk of network separation.

Similar reasoning can also be applied to WAPS, where a more robust solution will mitigate the risk for scenarios where additional transmission lines are tripped or where generation contingency size is increased.

4.2.4 Contingency size

The initial contingency size considered in the studies for destructive wind transfer limits after PEC Stage 1 was 500 MW, aligning with the approach taken in the design of the upgraded SIPS. However, after completion of the studies, including sensitivities for higher contingency sizes, it was determined that the nominal contingency size would be increased to 600 MW when calculating the new destructive wind transfer limits. This increased contingency size was chosen to provide additional margin to mitigate the risk of larger contingency sizes as more wind is connected to the South Australian network, such as the 400 MW Goyder Stage 1 Wind Farm.

Protected event contingency size

In AEMO's request for the declaration of the protected event, AEMO indicated that a number of factors were considered to determine that the loss of 500 MW of generation was the appropriate design standard. These factors included:

- There were a number of large wind farms in South Australia in 2019, such as the 279 MW Lake Bonney Wind Farm⁶⁵, that could be tripped by credible contingencies that may occur elsewhere in South Australia. This increased the potential of larger contingency sizes occurring.
- Historical non-credible contingency events involving the loss of generation have been in the range of 450 MW to 520 MW.
- The amount of load that can be shed as part of the upgraded SIPS was expected to be limited to 200 MW to 300 MW to avoid causing voltage disturbances in the power system which may lead to further load or generation tripping.
- Extensive studies by AEMO indicated that a 500 MW target capability for SIPS/WAPS would be challenging to meet under all conditions due to the uncertainties related to the response of South Australia load and DPV, actual system conditions prior to the event, and the sequence of tripping events during the incident.

To align with the approach taken in the upgraded SIPS design and the previous South Australia protected event, a contingency size of 500 MW was also considered for these studies. However, sensitivities were also completed to assess the impact that larger contingencies would have on the system.

Justification to increase contingency size to 600 MW

Since 2019, the system dispatch/operating conditions in South Australia have changed due to several different factors which impact the appropriate nominal contingency size considered in determining the destructive wind limits. Some factors mitigate the risk of larger contingencies and support a reduced nominal contingency size, while other factors suggest an increased risk of larger contingencies and support an increase in nominal contingency size.

Factors that could reduce the potential contingency size during destructive winds include:

- The maximum demand in South Australia has not increased significantly since 2016.

⁶⁵ Lake Bonney Wind Farm comprises the Lake Bonney 1 (80.5 MW), Lake Bonney 2 (159 MW) and Lake Bonney 3 (39 MW) wind farms.

- In 2019, the maximum recorded South Australia demand was 3,147 MW⁶⁶. In 2023, the maximum demand recorded was 3,084 MW⁶⁷.
- This implies that additional wind generation capacity installed in South Australia likely displaces other existing generation for South Australia import conditions.
- Since 2019, there have been no new major augmentations commissioned in the South Australia system that significantly impact dispatch conditions/network flows.
- Since the 2016 South Australia black system event⁶⁸, improvements have been made to generator performance standards and compliance, in particular regarding the multiple fault ride-through requirements.

However, there are also factors that could increase the potential contingency size during destructive winds, such as:

- The South Australia wind generation capacity is increasing, in particular once the 400 MW Goyder wind farm becomes operational⁶⁹.
 - Figure 6 below shows the voltage disturbances and transmission elements tripped during the 2016 South Australia black system event, including the additional South Australian wind generation since 2019. There are additional large wind farms in South Australia (Goyder wind farm > 400 MW) that could be tripped by similar disturbances occurring in South Australia during destructive winds, thereby increasing the potential of larger contingency sizes occurring.
 - Transmission line trips from the 2016 South Australia black system event are shown on the figure with:
 - Voltage Disturbance 2 showing the location of the trip of Brinkworth – Templers West 275 kV line.
 - Voltage Disturbance 3-4 showing the location of the trip of Davenport – Belalie 275 kV line
 - Voltage Disturbance 5-6 showing the location of the trip of Davenport – Mt Lock 275 kV line.
 - The figure also shows the location of the connection point for the Goyder Stage 1 Wind Farm, connecting into Robertstown and the Port Augusta Renewable Energy Park (PAREP) that connected near Davenport.

⁶⁶ See https://aemo.com.au/-/media/files/electricity/nem/planning_and_forecasting/sa_advisory/2020/2020-south-australian-electricity-report.pdf?la=en.

⁶⁷ See https://aemo.com.au/-/media/files/electricity/nem/planning_and_forecasting/sa_advisory/2023/2023-south-australian-electricity-report.pdf?la=en.

⁶⁸ See https://www.aemo.com.au/-/media/Files/Electricity/NEM/Market_Notices_and_Events/Power_System_Incident_Reports/2017/Integrated-Final-Report-SA-Black-System-28-September-2016.pdf.

⁶⁹ See https://www.aemo.com.au/-/media/Files/Electricity/NEM/Market_Notices_and_Events/Power_System_Incident_Reports/2017/Integrated-Final-Report-SA-Black-System-28-September-2016.pdf.

Figure 6 Map of South Australian transmission system showing location of 2016 black system event faults and significant new connections since 2019

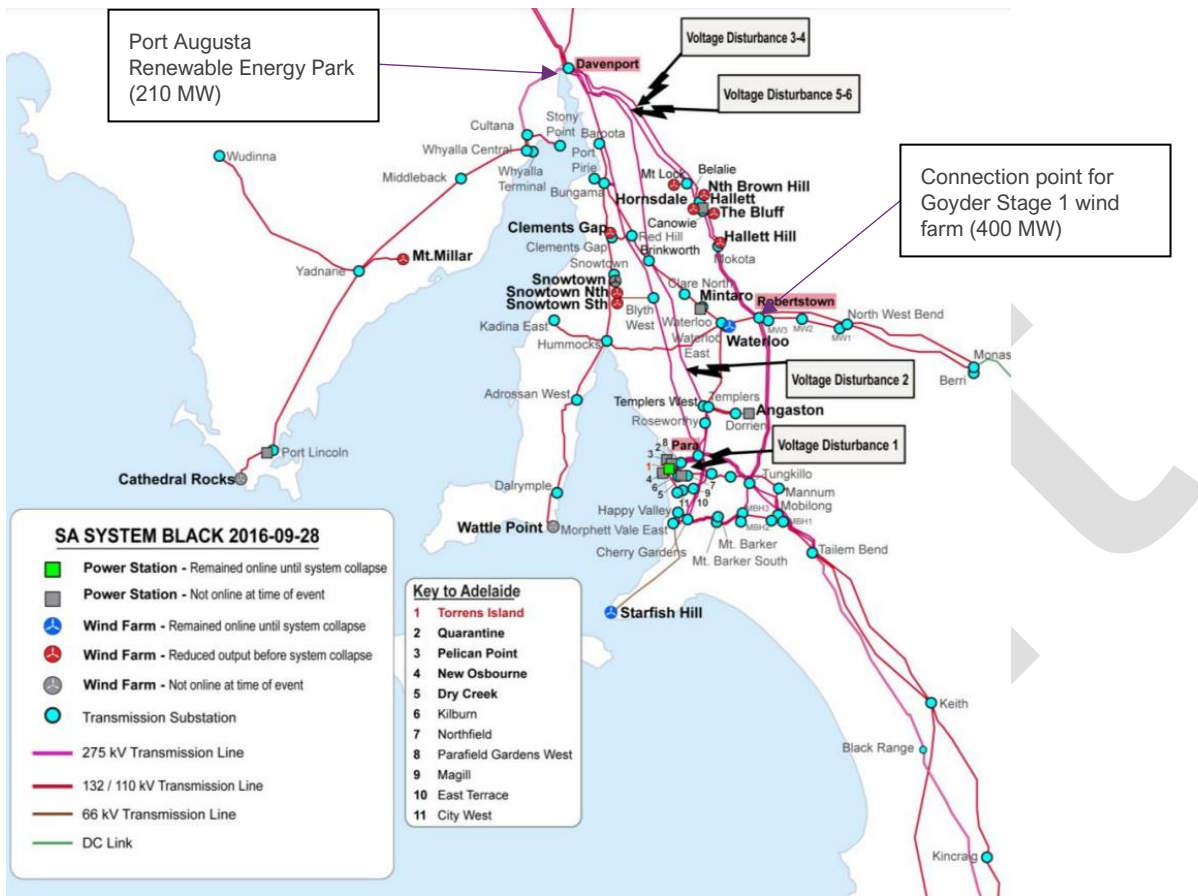

- The maximum South Australian wind generation has increased since 2019, due to both increasing capacity as well as changing operational constraints, as shown in Table 12.

Table 12 South Australia wind generation changes in registered capacity, 2017-18 to 2022-23

Financial year	Nameplate capacity (MW)	Reason for increase in capacity	Maximum five minute generation (MW)
2017-18	1,810	Hornsedale Stage 3 (112 MW)	1,618
2018-19	2,141	Lincoln Gap (212.4 MW), Willogoleche (119.36 MW)	1,713
2019-20	2,141	NA	1,823
2020-21	2,141	NA	1,826
2021-22	2,351	Port Augusta Renewable Energy Park (210 MW)	2,050
2022-23	2,348	NA	2,111

A. Nameplate capacity is taken from AEMO’s Generation Information publication and may change slightly from year to year.

- South Australia’s minimum synchronous generation unit requirements have been reduced from four units to two units following the commissioning of the four large synchronous condensers. As South Australian synchronous generation is generally more centrally located than wind generation, it is therefore less likely to

trip due to destructive wind/storm conditions. Therefore, synchronous generation being displaced by wind generation could result in increased potential generation contingency sizes during destructive winds.

Considering the factors detailed above, it was determined that, on balance, the factors that support an increase in the maximum contingency size outweighed the factors supporting a reduced contingency size. The largest contributing factor was the increase in the maximum instantaneous wind generation.

Due to this, an increased nominal contingency size of 600 MW was used to calculate the destructive wind limits. Additionally, the nominal contingency size used to calculate the destructive wind limits will be reviewed following any major changes in the South Australia system or operational conditions.

4.2.5 Dispatch selection

The cases in Table 13 below were chosen for initial studies to investigate the power transfer limits over the Heywood and PEC interconnectors. These cases were based on dispatches studied by ElectraNet and Manitoba Hydro International for the South Australia Interconnector Trip Remedial Action Scheme (SAIT RAS), the proposed PEC SPS.

Table 13 Initial base cases

Case Number	SA non-DER Load (MW)	DPV in SA (%)	Number of sync gens in SA	SA inertia (MWs)	SA synchronous generation (MW)	SA asynchronous generation (MW)	Heywood transfer (VIC->SA) (MW)	PEC transfer (NSW->SA) (MW)	Murraylink transfer (VIC->SA) (MW)	Combined SA import (HIC+PEC) (MW)
1	1,879	40	16	5,757	500	814	394	105	125	499
2	1,879	40	16	5,757	500	934	298	98	100	396
3	1,195	60	16	5,757	500	116	395	106	125	501
4	1,195	60	16	5,757	500	255	297	79	100	376
5	2,890	15	2	5,333	100	2,041	645	155	167	800
6	2,917	15	2	5,333	100	2,551	303	69	95	372
7	2,409	20	2	5,333	100	1,484	649	149	167	798
8	2,890	40	2	5,333	100	2,041	645	155	167	800
9	2,917	40	2	5,333	100	2,551	303	69	95	372
10	2,409	60	2	5,333	100	1,484	649	149	167	798
11	2,408	20	2	5,333	100	2,185	168	42	53	210
12	623	37	2	5,333	100	343	140	40	0	180
13	487	55	2	5,333	100	383	4	0	0	4
14	1,005	49	2	5,333	100	741	120	44	0	164
15	509	50	3	6,200	150	209	120	30	0	150
16	1,121	52	4	7,400	200	567	304	50	0	354

A. These cases were based on the ElectraNet and MHI studies undertaken for the SAIT RAS. Cases 1-4 have a large number of smaller synchronous machines online.

Base case dispatches

The base case model dispatch patterns cover a wide range of variables that could impact model stability. Variables such as DPV, inertia, load, generation and interconnector power flow were modified to create cases. These cases were developed to investigate the following conditions:

- High/low number of synchronous generators online in South Australia.
- High/low South Australia load.
- High/low online DPV in South Australia.
- High/low asynchronous generation dispatched in South Australia.
- High/low transfer levels over Heywood and PEC Stage 1.

From this cross section of parameters, an understanding of the limits of the system could be achieved, and sensitivity studies could be chosen to further investigate the transfer limits.

DPV penetration

A key parameter that was investigated in detail was DPV penetration. This was varied across the base case dispatches such that the impact of low and high DPV dispatches could be investigated, in the presence of high and low load, and for various fault locations.

4.3 Study acceptance criteria

The following acceptance criteria were used when assessing the results of these studies:

- Pre-disturbance and post-disturbance voltages at key transmission node are within an acceptable range.
- Electromechanical oscillations are adequately damped.
- Post fault voltage oscillations are adequately damped.
- System frequencies are maintained with the applicable extreme frequency excursion tolerance limits as defined in the FOS⁷⁰. Note that it is also stated in the FOS that, following a non-credible contingency event, AEMO should use reasonable endeavours to maintain the rate of change of frequency within +/- 3 hertz per second (Hz/s). For the UFLS screening studies, a frequency nadir threshold of 47.6 Hz was used, because below this value cascading failure to a black system is considered likely. Setting the threshold at 47.6 Hz allows a buffer of 0.6 Hz over the requirement in the FOS, to account for modelling uncertainty.
- No instability or tripping of IBR is observed due to the contingency.
- The non-credible contingency does not lead to the loss or instability of a system interconnector or a cascading failure (except for the UFLS screening studies).
- The PSS®E or PSCAD™ simulation successfully completes, and no numerical instability is observed.

⁷⁰ The FOS is available at <https://www.aemc.gov.au/sites/default/files/2023-04/FOS%20-%20CLEAN.pdf>.

5 Study results and observations

Table 14 shows the symbols used in the summaries of simulation results below.

Table 14 Legend for historical results table

Result	Symbol
Pass	✓
Marginal pass	⚠
Fail	✗

5.1 Priority risk 1: CBF event in Latrobe Valley leading to trip of multiple large generating units and Basslink instability

Table 15 summarises the assessment of the simulations using the key parameters described in Section 4.1.1, against the acceptance criteria detailed in Section 4.3. Key findings, observations and a recommendation follow the table, as well as observations from a sensitivity.

Table 15 Priority risk 1 study results (Basslink flow Tasmania to Victoria)

Combination	2ph-G		3ph-G	
	175 ms	100 ms	175 ms	100 ms
VIC_9	✗	✓	✗	✗
VIC_39	✗	✓	✗	✓

Key findings

- Immediately following the contingency, for the VIC_39 combination, the only synchronous generating unit that remained online in Victoria is Loy Yang A3. For the VIC_9 combination, only the Loy Yang A3 and Newport synchronous generating units remained online.
- The VIC_39 case failed the acceptance criteria following the application of a 2ph-G fault with a clearance time of 175 ms.
 - The instability observed with the VIC_39 combination was initially caused by the pole slipping of the remaining Loy Yang A3 unit. As the Loy Yang A3 generating unit became unstable, the voltages in Victoria collapsed and large oscillations in VNI flow could be observed. This led to a cascading failure of the whole power system.
 - For VIC_39 combination, Basslink tripped as the power system became unstable due to cascading failures.
- The VIC_9 case failed the acceptance criteria following the application of a 2ph-G fault with a clearance time of 175 ms.

- Significant oscillations and overvoltage conditions were observed following the contingency.
- High voltages were observed around the Darlington Point, Wagga, and Jindera areas. The peak overvoltages were up to 1.27 pu, and the steady state overvoltage conditions were just above 1.15 pu.
- Significant oscillations were observed in the active power and reactive power flows of the interconnectors, particularly for VNI. The Heywood interconnector flow swung to over 950 MW immediately after the contingency but became stable at around 620 MW.
- Moorabool Wind Farm tripped following the contingency, and poor ride-through behaviour of several other IBR generators was observed.
- The frequency nadir measured at Hazelwood was approximately 49.1 Hz following fault clearance.
- Both the VIC_39 and VIC_9 cases became unstable when a 3ph-G fault was applied and cleared at 175 ms.
 - For both cases, the Loy Yang A3 unit lost stability due to pole slipping, which led to the cascading failure of the power system.
- When the fault clearance time was reduced to 100 ms, the VIC_39 case became stable for both 2ph-G and 3ph-G faults. However, damped oscillations were still observed in the active power output of the remaining Loy Yang A3 unit.
- For the VIC_9 case, when a 3ph-G fault was applied and cleared at 100 ms, large oscillations and overvoltage conditions were observed (similar to when a 2ph-G fault was applied and cleared after 175 ms).

Other observations

Additional observations that do not impact the acceptance criteria are outlined below:

- Unmodelled system dynamics, such as the response of DPV generation to the power system fault, could significantly increase the effective contingency size.

Recommendations and plans for future GPSRRs

Recommendation 1

Given the criticality of the site for system reliability as well as system strength and security, AEMO recommends that AEMO Victorian Planning (AVP) design and implement a suitable solution to improve the overall resilience of the Loy Yang substation as a priority and share its findings with AEMO for consideration in future GPSRRs.

Studies completed for priority risk 1 (CBF event in Latrobe Valley leading to trip of multiple large generating units and Basslink instability) highlight the potential impact of CBF events, particularly in the context of operation with fewer synchronous generators online. In the next GPSRR, AEMO plans to review critical CBF contingencies in the NEM which have the potential to trip multiple synchronous generating units.

5.1.1 Basslink commutation failure

In addition to monitoring the performance of Basslink in the above studied scenarios as outlined in Section 4.1.1, additional sensitivities were completed with different fault inception times, to assess the impact of Point-on-Wave

(PoW) on the commutation fail time of Basslink. Basslink trips if the thyristor monitoring protection delay time is less than the commutation fail time, which would significantly increase the total contingency size. Cases with Basslink flows from Tasmania to Victoria were studied, as the contingency is more severe if Basslink trips on extended commutation failure due to the increase in total contingency size in Victoria, which could potentially lead to cascading failures.

Shallow faults of 0.7 pu and 0.35 pu with the maximum fault clearance time of 175 ms were considered in this study considering the behaviour of the protection system associated with Basslink for shallow faults (for deep faults, the thyristor monitoring protection is inhibited). The PoW of fault inception was varied in 1 ms increments from 0° to 90° of phase A resulting in five sensitivities per case.

Table 16 Priority risk 1 PoW sensitivity study results

Combination	PoW (ms) for a 0.7 pu fault voltage						PoW (ms) for a 0.35 pu fault voltage						
	0	1	2	3	4	5	0	1	2	3	4	5	
VIC_9	✓	✓	✓	✓	✓	✓	✓	✓	✓	✓	✓	✓	✓
VIC_39	✓	✓	✓	✓	✓	✓	✓	✓	✓	✓	✗	✓	✓

The time from the application of fault to DC current reaching zero was considered approximately equal to the commutation fail time. The maximum commutation fail time observed in the sensitivities was around 100 ms for a 0.35 pu voltage with the VIC_39 combination, which is shown in Figure 7.

Figure 7 VIC_39 case, Basslink DC current

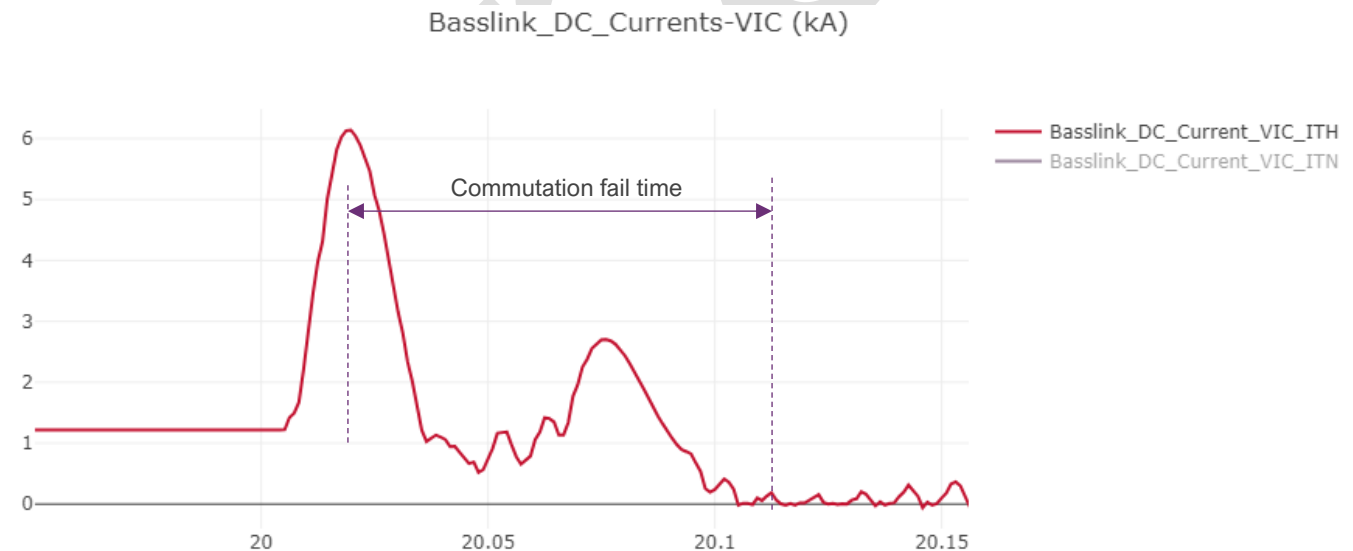

Generally, the Basslink commutation failure time increases with the severity of the fault – as the fault voltage decreases, the commutation failure time increases (see Figure 8).

Figure 8 Basslink commutation failure times for sensitivity studies

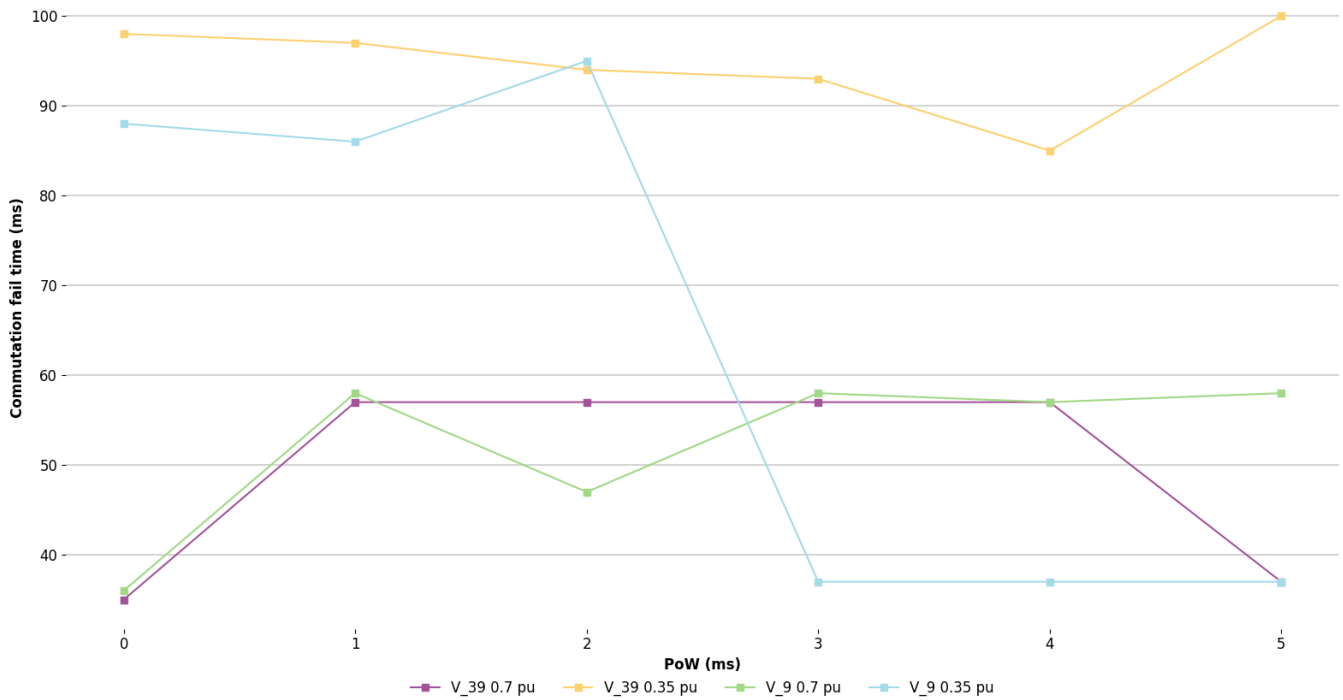

Key findings

- All the sensitivities, except one case, were marginal passes due to the presence of oscillations, in particular in the active power output of the Loy Yang A3 synchronous generating unit.
- The sensitivity 4 ms PoW for a fault voltage of 0.35 pu of VIC_39 combination case failed as the contingency caused the cascaded failure of the power system and resulted in simulation numerical instability.
- The commutation fail time increased with the severity of the fault – longer commutation fail times were observed for 0.35 pu fault voltage.
- The maximum commutation fail time observed was around 100 ms for a PoW of 5 ms for a fault voltage of 0.35 pu with VIC_39 combination.
- Basslink trips if the thyristor monitoring protection delay time is less than the commutation fail time. The commutation failure times observed for the 2024 GPSRR studies were less than the current thyristor monitoring protections delay time settings for Basslink. However, system strength conditions in Victoria could impact the commutation failure time and the overall stability of the HVDC link.
 - It is important to note that the minimum fault level requirements for stable operation of Basslink for the Victorian side are not formally defined. However, based on the initial studies completed, it was found that commutation failure outcomes are primarily influenced by fault characteristics rather than system strength – similar situations could be encountered at higher fault levels at Loy Yang.

5.2 Priority risk 2: Non-credible loss of the future double-circuit HumeLink 500 kV lines

Table 17 summarises the assessment of the simulations using the key parameters described in Section 4.1.2, against the acceptance criteria detailed in Section 4.3. Table 18 shows the assessment of the simulations with the Transgrid network model (see Section 4.1.2) against the acceptance criteria in Section 4.3.

Key findings and observations follow the table. A recommendation follows observations from sensitivity studies in Section 5.2.1.

Table 17 Future study results

Case	Timestamp	Bannaby	Gugaa	Maragle
1	7/06/2029 0500 hrs	✘	✔	✔
2	29/11/2028 1500 hrs	✔	✔	✔
3	29/06/2029 1000 hrs	✘	✔	✔
4	15/07/2028 2230 hrs	✘	✔	✔
5	9/03/2029 0330 hrs	✔	✔	✔
6	26/08/2028 1230 hrs	✔	✔	✔

Table 18 Future study results: Transgrid cases

Case	Bannaby	Gugaa	Maragle
T1	✔	✔	✔
T2	✘	✔	✔
T3	✔	✔	✔
T4	✔	✔	✔
T5	✔	✔	✔
T6	✔	✔	✔

Key findings

The future studies of non-credible loss of the future HumeLink double-circuit 500 kV lines identified the following key findings in relation to the stated acceptance criteria:

- Voltage collapse occurred around Bannaby following the loss of both Bannaby lines for dispatches with high northerly HumeLink flows.
 - Voltage collapse was observed in both the AEMO and Transgrid simulations.

- The Transgrid cases that included Sydney Ring Option 2 (Southern 500 kV loop)⁷¹ (cases T1 and T2) were stable for higher pre-contingent northerly HumeLink flows (> 2,000 MW) following the loss of both Bannaby lines. The AEMO cases and Transgrid cases that did not include the Sydney Ring Option 2 augmentation showed voltage collapse around Bannaby for northerly HumeLink flows of approximately 1,600-1,850 MW.
- For cases with high northerly HumeLink flows that were stable following the loss of both Bannaby lines, low steady-state voltages were observed around Bannaby and Marulan after fault clearance.
 - For multiple cases, the voltage at the Marulan 330 kV PSS®E bus settled below 0.9 pu.
- For cases with high northerly HumeLink flows that were stable following the loss of both Bannaby lines, high flows on the remaining 330 kV lines from Maragle through Upper/Lower Tumut to Wagga were seen after fault clearance.
 - For example, for the AEMO cases, the steady-state flows on the 330 kV Lower Tumut – Yass (03) and Lower Tumut – Canberra (07) lines exceeded 1,000 MVA after the loss of the HumeLink lines for some cases. The 5-minute ratings of the Lower Tumut – Yass (03) and Lower Tumut – Canberra (07) lines are 1,257 MVA and 1,143 MVA, respectively.
 - For the cases studied, no thermal overloads on the 330 kV lines were observed, but there may be the possibility of thermal overloads on the 330 kV lines from Lower Tumut to northern New South Wales following the loss of both Bannaby lines for other dispatch conditions.
- All AEMO and Transgrid cases studied were stable following the non-credible loss of both Gugaa HumeLink lines.
- All AEMO and Transgrid cases studied were stable following the non-credible loss of both Maragle HumeLink lines, however:
 - Transgrid has advised AEMO that following the commissioning of Snowy 2.0, there is the possibility of thermal overloads on the 330 kV Lower Tumut – Upper Tumut (64) line following the loss of both Maragle lines. There is also the possibility of Snowy 2.0-unit instability and low voltages around Southern New South Wales.
- All cases with high southerly HumeLink flows were stable following the non-credible HumeLink contingencies.
 - Transgrid has advised AEMO that previous studies showed high steady-state voltages (>1.1 pu) around Maragle following the loss of HumeLink for dispatches with high southerly HumeLink flows.
 - Further studies are required with Snowy 2.0 pumping during low demand periods to assess system stability for the non-credible loss of the HumeLink lines for high southerly flow conditions.

Other observations

Additional observations that do not impact the acceptance criteria are outlined below:

⁷¹ Sydney Ring Option 1 (Northern 500 kV loop) was selected in the optimal development path (ODP) of the 2022 ISP and 2024 ISP. Option 2 (Sydney Ring Southern 500 kV loop) was not selected in the ODP of the 2022 ISP so was not modelled for the 2024 GPSRR studies.

- The 2022 ISP *Step Change* market modelling FY 2028-29 dispatch data excluding Snowy 2.0 that was used for the 2024 GSRR studies resulted in fewer periods with very high northerly (>2,000 MW) or southerly (>1,000 MW) HumeLink flows. The remedial measures currently being undertaken by Transgrid to avoid voltage collapse occurring for the non-credible loss of the HumeLink lines will be further justified following the commissioning of the Snowy 2.0 generation, due to the resultant higher average northerly HumeLink flows.

5.2.1 Sensitivity studies

Constraining/reducing pre-contingent HumeLink flow to prevent voltage collapse

Sensitivities were completed with reduced pre-contingent northerly HumeLink flows to determine the HumeLink flow level at which there is voltage collapse following the loss of both Bannaby lines. The northerly HumeLink flows were reduced by increasing generation north of Bannaby and decreasing generation south of Maragle and flow into New South Wales over VNI.

The study results showed that, without the Sydney Ring Option 2 (Southern 500 kV loop)⁷² augmentation, the maximum northerly HumeLink flow before voltage collapse occurs following the loss of both Bannaby HumeLink lines was approximately 1,600-1,800 MW. For the Transgrid cases that include the Sydney Ring Option 2 augmentation (T1 and T2), the maximum northerly flow before voltage collapse occurs was ~2,200 MW. Therefore, the Sydney Ring Option 2 augmentation significantly impacts voltage collapse around Bannaby for the non-credible loss of the HumeLink lines for northerly flow conditions.

Table 19 Maximum northerly HumeLink flow at which no voltage collapse occurs (sensitivity studies)

Case	Maximum northerly HumeLink flow (MW) before voltage collapse occurs
1	1,650
2	1,790
3	1,750
4	1,600
T1	2,200
T2	2,300
T3	1,800
T4	1,800

Reactive compensation

As stated above, for cases with high northerly HumeLink flows that were stable following the loss of both Bannaby HumeLink 500 kV lines, low steady-state voltages were observed around Bannaby and Marulan after fault clearance.

Sensitivities were completed with different reactive compensation options to evaluate the improvement to the steady-state voltages around Bannaby/Marulan. Capacitor banks, a synchronous condenser, and Static VAR

⁷² Sydney Ring Option 1 (Northern 500 kV loop) was selected in the ODP of the 2022 ISP and 2024 ISP. Option 2 (Sydney Ring Southern 500kV loop) was not selected in the ODP of the 2022 ISP and therefore was not modelled for the 2024 GPSRR studies.

Compensators (SVC) of different sizes were included at different locations. The dynamic model of an existing SVC model was used to model the fictitious SVC.

As expected, the sensitivities showed that reactive compensation of a sufficient size could improve the steady-state voltage around Bannaby/Marulan following the loss of both Bannaby lines for northerly HumeLink flows (refer to Appendix A5.2.4 for detailed results). The results also indicated that an SVC or synchronous condenser at Bannaby can improve the steady-state voltage after fault clearance but cannot prevent voltage collapse for higher northerly flows.

For cases where voltage collapse around Bannaby occurred following the loss of both Bannaby lines (excluding the Sydney Ring Option 2 (Southern 500 kV loop)⁷² augmentation), sensitivities were also completed to determine if an SVC placed at Canberra/Yass or Bannaby could prevent voltage collapse for higher northerly HumeLink flows. It was determined that an SVC larger than 500 MVAR at Canberra would be required to prevent voltage collapse for northerly HumeLink flows of approximately 1,700 MW. An SVC larger than 800 MVAR would be required to prevent voltage collapse for northerly HumeLink flows of approximately 2,000 MW. No size of SVC placed at Bannaby prevented voltage collapse for high northerly flows. Therefore, it is unlikely that the implementation of any reasonably sized dynamic reactive compensation options could prevent voltage collapse for higher northerly HumeLink flows following the loss of both Bannaby lines.

RAS options

For cases where voltage collapse around Bannaby was observed following the loss of both Bannaby lines, additional sensitivities were completed tripping load north of Bannaby and generation south of Maragle within 250 ms. The results indicated that tripping load and generation through the action of a RAS could prevent voltage collapse. However, for the dispatches studied, more than 1,000 MW of generation and load had to be tripped to ensure stability. A summary of the results for these sensitivities is in Table 20.

Table 20 RAS sensitivity results

Case	Pre-contingent HumeLink flow (MW)	Load tripped (MW)	Generation tripped (MW)
1	2,300	1,500	1,500
3	1,863	1,200	1,200
4	2,108	1,000	1,000

Recommendation 2

Given the potentially significant impact of non-credible loss of HumeLink 500 kV circuits during times of high northerly flows, AEMO recommends that, in accordance with NER S5.1.8, Transgrid continue to:

- Implement cost-effective measures where practical, such as surge arrestors, increased tower clearances or single-phase auto-reclose circuit breakers, to minimise the probability of the tripping of both HumeLink 500 kV circuits.
- Investigate reactive compensation options around Bannaby, accounting for benefits of managing both credible and non-credible contingency events.

- If a scheme is found viable, in consultation with AEMO, design and implement an emergency control scheme to mitigate risks associated with voltage collapse in the Bannaby area as well as 330 kV line thermal overloads by the expected HumeLink in-service date of 2026.

5.3 Priority risk 3: UFLS screening studies

Results for historical and future screening studies are in Section 5.3.1 and Section 5.3.2 below, with key findings and observations. A recommendation is included in Section 5.3.2. A summary of all results is in Section 5.3.3.

5.3.1 Historical UFLS screening study results

Table 21 and Table 22 show the assessment of all historical simulations against the acceptance criteria detailed in Section 4.3. Appendix A5 contains the detailed results for each historical case and contingency.

A standard set of 15 historical dispatches were studied for each contingency. The key parameters of each of the future dispatch studies are detailed in Appendix A4.

Table 21 Historical study results summary against acceptance criteria

Case	Contingency 1	Contingency 2	Contingency 3	Contingency 4	Contingency 5	Contingency 6	Contingency 7	Contingency 8	Contingency 9
1	✔, NEM freq nadir = 49.7 Hz	✔, NEM freq nadir = 49.0 Hz	✔, NEM freq nadir = 48.9 Hz	✔, NEM freq nadir = 48.9 Hz	✔, NEM freq nadir = 48.9 Hz	✔, NEM freq nadir = 48.8 Hz	✔, NEM freq nadir = 49.0 Hz	✔, NEM freq nadir = 48.9 Hz	✔, NEM freq nadir = 48.9 Hz
2	✔, NEM freq nadir = 48.8 Hz	✔, NEM freq nadir = 49.6 Hz	✔, NEM freq nadir = 49.4 Hz	✔, NEM freq nadir = 48.9 Hz	✔, NEM freq nadir = 48.6 Hz	✔, NEM freq nadir = 48.8 Hz	✔, NEM freq nadir = 48.7 Hz	✔, NEM freq nadir = 48.9 Hz	✔, NEM freq nadir = 48.6 Hz
3	✔, NEM freq nadir = 49.8 Hz	✔, NEM freq nadir = 48.8 Hz	✔, NEM freq nadir = 48.8 Hz	✔, NEM freq nadir = 48.9 Hz	✔, NEM freq nadir = 48.7 Hz	✔, NEM freq nadir = 48.8 Hz	✔, NEM freq nadir = 48.8 Hz	✔, NEM freq nadir = 48.9 Hz	✔, NEM freq nadir = 48.6 Hz
4	✔, NEM freq nadir = 49.9 Hz	✔, NEM freq nadir = 48.8 Hz	✔, NEM freq nadir = 48.7 Hz	✔, NEM freq nadir = 48.9 Hz	✔, NEM freq nadir = 48.7 Hz	✔, NEM freq nadir = 48.7 Hz	✔, NEM freq nadir = 49.0 Hz	✔, NEM freq nadir = 48.9 Hz	✔, NEM freq nadir = 48.9 Hz
5	✔, NEM freq nadir = 49.7 Hz	✔, NEM freq nadir = 49.0 Hz	✔, NEM freq nadir = 49.0 Hz	✔, NEM freq nadir = 48.9 Hz	✔, NEM freq nadir = 48.9 Hz	✔, NEM freq nadir = 48.9 Hz	✔, NEM freq nadir = 49.7 Hz	✔, NEM freq nadir = 49.1 Hz	✔, NEM freq nadir = 48.5 Hz
6	✔, NEM freq nadir = 49.5 Hz	✔, NEM freq nadir = 49.0 Hz	✔, NEM freq nadir = 49.0 Hz	✔, NEM freq nadir = 49.0 Hz	✔, NEM freq nadir = 48.9 Hz	✔, NEM freq nadir = 48.8 Hz	✔, NEM freq nadir = 49.0 Hz	✔, NEM freq nadir = 49.0 Hz	✔, NEM freq nadir = 48.9 Hz
7	✔, NEM freq nadir = 48.8 Hz	✔, NEM freq nadir = 48.8 Hz	✔, NEM freq nadir = 48.8 Hz	✔, NEM freq nadir = 48.9 Hz	✔, NEM freq nadir = 48.5 Hz	✔, NEM freq nadir = 48.5 Hz	✔, NEM freq nadir = 49.4 Hz	✔, NEM freq nadir = 48.9 Hz	✔, NEM freq nadir = 48.6 Hz
8	✔, NEM freq nadir = 49.7 Hz	✔, NEM freq nadir = 48.8 Hz	✔, NEM freq nadir = 48.8 Hz	✔, NEM freq nadir = 49.0 Hz	✔, NEM freq nadir = 48.6 Hz	✔, NEM freq nadir = 48.6 Hz	✔, NEM freq nadir = 48.7 Hz	✔, NEM freq nadir = 48.7 Hz	✔, NEM freq nadir = 48.4 Hz
9	✔, NEM freq nadir = 49.7 Hz	✔, NEM freq nadir = 49.2 Hz	✔, NEM freq nadir = 49.2 Hz	✔, NEM freq nadir = 49.0 Hz	✘, NEM freq nadir = 48.8 Hz, QLD freq peak > 52 Hz	✔, NEM freq nadir = 48.9 Hz	✔, NEM freq nadir = 49.0 Hz	✔, NEM freq nadir = 49.0 Hz	✔, NEM freq nadir = 48.4 Hz
10	✔, NEM freq nadir = 48.9 Hz	✔, NEM freq nadir = 48.8 Hz	✔, NEM freq nadir = 48.8 Hz	✔, NEM freq nadir = 48.8 Hz	✔, NEM freq nadir = 48.6 Hz	✔, NEM freq nadir = 48.8 Hz	✔, NEM freq nadir = 48.8 Hz	✔, NEM freq nadir = 48.8 Hz	✔, NEM freq nadir = 48.1 Hz
11	✔, NEM freq nadir = 49.8 Hz	✔, NEM freq nadir = 49.0 Hz	✔, NEM freq nadir = 48.9 Hz	✔, NEM freq nadir = 48.9 Hz	✔, NEM freq nadir = 48.9 Hz	✔, NEM freq nadir = 48.8 Hz	✔, NEM freq nadir = 49.0 Hz	✔, NEM freq nadir = 48.9 Hz	✔, NEM freq nadir = 48.9 Hz
12	✔, NEM freq nadir = 48.8 Hz	✔, NEM freq nadir = 48.6 Hz	✔, NEM freq nadir = 49.4 Hz	✔, NEM freq nadir = 48.9 Hz	✔, NEM freq nadir = 48.7 Hz	✔, NEM freq nadir = 48.8 Hz	✔, NEM freq nadir = 49.3 Hz	✔, NEM freq nadir = 49.0 Hz	✔, NEM freq nadir = 48.6 Hz
13	✔, NEM freq nadir = 49.5 Hz	✔, NEM freq nadir = 49.0 Hz	✔, NEM freq nadir = 49.0 Hz	✔, NEM freq nadir = 49.0 Hz	✔, NEM freq nadir = 48.8 Hz	✔, NEM freq nadir = 48.8 Hz	✔, NEM freq nadir = 49.1 Hz	✔, NEM freq nadir = 49.0 Hz	✔, NEM freq nadir = 48.9 Hz

Case	Contingency 1	Contingency 2	Contingency 3	Contingency 4	Contingency 5	Contingency 6	Contingency 7	Contingency 8	Contingency 9
14	☑, NEM freq nadir = 49.6 Hz	☑, NEM freq nadir = 49.5 Hz	☑, NEM freq nadir = 49.1 Hz	☑, NEM freq nadir = 49.0 Hz	☑, NEM freq nadir = 48.8 Hz	☑, NEM freq nadir = 48.8 Hz	☑, NEM freq nadir = 49.0 Hz	☑, NEM freq nadir = 49.0 Hz	☑, NEM freq nadir = 48.7 Hz
15	☑, NEM freq nadir = 49.8 Hz	☑, NEM freq nadir = 49.0 Hz	☑, NEM freq nadir = 48.9 Hz	☑, NEM freq nadir = 48.9 Hz	☑, NEM freq nadir = 48.9 Hz	☑, NEM freq nadir = 48.7 Hz	☑, NEM freq nadir = 49.0 Hz	☑, NEM freq nadir = 48.9 Hz	☑, NEM freq nadir = 48.9 Hz

Table 22 Historical study results summary against acceptance criteria

Case	Contingency 10	Contingency 11	Contingency 12
1	☑, NEM freq nadir = 48.9 Hz	☑, NEM freq nadir = 50.0 Hz	☑, NEM freq nadir = 49.9 Hz
2	☑, NEM freq nadir = 50.0 Hz	☑, NEM freq nadir = 49.0 Hz	☑, NEM freq nadir = 49.9 Hz
3	☑, NEM freq nadir = 50.0 Hz	☑, NEM freq nadir = 49.8 Hz	☑, NEM freq nadir = 49.9 Hz
4	☑, NEM freq nadir = 49.9 Hz	☑, NEM freq nadir = 49.7 Hz	☑, NEM freq nadir = 50.0 Hz
5	☑, NEM freq nadir = 49.5 Hz	☑, NEM freq nadir = 50.0 Hz	☑, NEM freq nadir = 49.9 Hz
6	☑, NEM freq nadir = 49.2 Hz	☑, NEM freq nadir = 50.0 Hz	☑, NEM freq nadir = 50.0 Hz
7	☑, NEM freq nadir = 50.0 Hz	☑, NEM freq nadir = 49.2 Hz	☑, NEM freq nadir = 49.9 Hz
8	☑, NEM freq nadir = 50.0 Hz	☑, NEM freq nadir = 49.3 Hz	☒, SA freq nadir = 46.5 Hz
9	☑, NEM freq nadir = 50.0 Hz	☑, NEM freq nadir = 49.9 Hz	☑, NEM freq nadir = 50.0 Hz
10	☑, NEM freq nadir = 48.5 Hz	☑, NEM freq nadir = 49.2 Hz	☒, SA freq nadir = 47.8 Hz
11	☑, NEM freq nadir = 49.0 Hz	☑, NEM freq nadir = 49.9 Hz	☑, NEM freq nadir = 49.8 Hz
12	☑, NEM freq nadir = 50.0 Hz	☑, NEM freq nadir = 49.1 Hz	☑, NEM freq nadir = 50.0 Hz
13	☑, NEM freq nadir = 49.0 Hz	☑, NEM freq nadir = 50.0 Hz	☑, NEM freq nadir = 49.9 Hz
14	☑, NEM freq nadir = 50.0 Hz	☑, NEM freq nadir = 50.0 Hz	☒, SA freq nadir = 47.3 Hz
15	☑, NEM freq nadir = 50.0 Hz	☑, NEM freq nadir = 49.8 Hz	☑, NEM freq nadir = 50.0 Hz

Key findings

The historical UFLS screening studies identified the following key findings in relation to the stated acceptance criteria:

- Studies completed by AEMO as part of the 2024 GPSRR indicated that, for all the significant multiple frequency events not resulting in regional separation assessed, there is sufficient EUFR available across the mainland NEM regions to arrest system frequency.
- Based on the cases studied, South Australia UFLS and large-scale BESS availability is not adequate to arrest frequency for South Australia separation followed by the loss of two stations for some South Australia import dispatch conditions.
 - For Case 8, the South Australian frequency fell to 47 Hz.
 - For Case 14, the South Australian frequency fell to 47.3 Hz.
- For all historical dispatches and contingencies except Case 8 and Case 14, the mainland NEM, South Australia and Queensland RoCoF remained below 3 Hz/s.
 - For Case 8, following the loss of Heywood, Torrens Island Power Station (TIPS) B and Pelican Point units, South Australian RoCoF reached 3.5 Hz if Heywood and the generating units were tripped simultaneously. For Case 8, there was high import into South Australia over Heywood and high TIPS B and Pelican Point generation, resulting in a low frequency nadir in South Australia (47 Hz) and a high South Australian RoCoF. If the Pelican Point generation was tripped 1 s after Heywood, and the TIPS B generation was tripped 2 s after Heywood, the maximum South Australia RoCoF was reduced to 2.5 Hz/s and the frequency nadir in South Australia was 47.6 Hz.
 - For Case 14, following the loss of Heywood, TIPS B and Pelican Point units, South Australia RoCoF reached 3.2 Hz if Heywood and the generating units were tripped simultaneously. For Case 14, there was high import into South Australia over Heywood and high TIPS B and Pelican Point generation, resulting in a low frequency nadir in South Australia (47.3 Hz) and a high South Australia RoCoF. If the Pelican Point generation was tripped 1 s after Heywood, and the TIPS B generation was tripped 2 s after Heywood, the maximum South Australia RoCoF was reduced to 1.7 Hz/s and the frequency nadir in South Australia was 47.7 Hz.
 - At RoCoF beyond 3 Hz/s, there is low confidence that EFCSs will operate properly to arrest a disturbance⁷³.
- Based on the cases studied, Queensland UFLS availability is currently adequate to arrest frequency for Queensland separation followed by the loss of multiple units for Queensland import conditions.
- Consistent with findings from the 2022 PSFRR, the historical results show that, when Queensland is exporting, Queensland frequency could rise above 52 Hz following the loss of QNI (in particular, for nighttime conditions).

⁷³ AEMO (2022) AEMO Advice: Reliability Panel Review of Frequency Operating Standard, Section 3.2, <https://www.aemc.gov.au/sites/default/files/2022-12/AEMO%20FOS%20advice%20to%20the%20Reliability%20Panel%20FINAL%20for%20Publishing%20221205.pdf>.

To regulate frequency to meet the FOS, AEMO is collaborating with Powerlink to develop an OFGS for Queensland to manage over-frequency during separation.

- It was observed that QNI can lose stability following large generation contingencies south of Queensland for high Queensland export conditions, and large generation contingencies in Queensland for high Queensland import conditions.
 - As discussed in Appendix A4, the QNI inhibit scheme was originally designed to reduce the risk of QNI from losing stability for large generation contingencies south of Queensland for high Queensland export scenarios where UFLS operates. From the 2024 GPSRR studies, it was observed that, for all cases where QNI went unstable, Queensland lost synchronism with the rest of the mainland NEM prior to the frequency dropping below 49 Hz and UFLS operating. Therefore, the changes in the arming of UFLS blocks in Queensland as a result of the inhibit scheme did not impact QNI stability.
 - There is a need for this scheme to be reviewed given the changes in NEM dispatches, Queensland UFLS availability, and QNI flows, in particular following the completion of the QNI Minor upgrade. The results of the 2024 GPSRR UFLS studies indicated that the QNI inhibit scheme is ineffective at preventing QNI instability for remote frequency disturbances south of Queensland for the majority of Queensland export conditions.
 - The existing regional large-scale BESS contributed significantly to the arrest of frequency for significant multiple contingency events. The BESS headroom availability therefore directly impacts the system frequency performance. For example, for Case 8, if the Wandoan BESS had no available headroom, the Queensland frequency exceeded 52 Hz following separation.
- Large swings on the Heywood interconnector were observed for South Australian export conditions in response to remote generation contingencies if the Torrens Island large-scale BESS was included.
 - For Case 11, following the loss of the Loy Yang A and Millmerran units, the Heywood interconnector flow reached >900 MW into Victoria within 5 seconds (from a pre-contingent flow of 640 MW) and there was voltage collapse around South East, which resulted in South Australia losing synchronism with the rest of the NEM.
 - It was found that if the pre-contingent Heywood interconnector flow was reduced below 600 MW, the case was marginally stable following this multiple contingency event.
 - Sensitivities were completed with the Victoria Big Battery out of service. Without BESS headroom available in Victoria, the observed swing on the Heywood interconnector following a remote generation contingency was increased.
 - For reference, during the 13 February 2024 Victoria power system event involving the loss of the Loy Yang A generating units, the initial swing on the Heywood interconnector towards Victoria that was observed was approximately 200 MW⁷⁴. However, the Torrens Island BESS was not online during this event as it was still undergoing commissioning, so there was significantly less total BESS headroom available in South Australia.

⁷⁴ See https://aemo.com.au/-/media/files/electricity/nem/market_notices_and_events/power_system_incident_reports/2024/preliminary-report---loss-of-moorabool---sydenham-500-kv-lines-on-13-feb-2024.pdf?la=en.

- Therefore, it is important to note that the location of large-scale BESS greatly impacts power system stability, as fast discharging/charging in response to remote frequency disturbances could cause large swings on interconnectors. This is further discussed in Section 6.14.2

Other observations

Additional observations that do not impact the acceptance criteria are outlined below:

- As discussed in Appendix A4, sensitivities for all future dispatches and contingencies were completed tripping different percentages of regional DPV to represent voltage-related DPV shake-off which cannot be simulated using the simplified model. The study results showed that the percentage of regional DPV that trips following a contingency event directly impacts the frequency performance of the power system. Therefore, depending on the actual performance of DPV generation⁷⁵, the effective contingency size of the multiple contingency events studied may be larger, which would result in a larger frequency disturbance.
 - The system frequency response is also very dependent on the load shake-off following a contingency, which may reduce the effective contingency size for a loss of generation event. For example, the significant multiple contingency event in Victoria on 13 February 2024 involved approximately 1,000 MW of load shake-off⁷⁶. As discussed in Appendix A4, the simplified model cannot simulate load shake-off.
- For several cases, a significant amount of DPV was tripped on inverter settings due to the system frequency falling below 49 Hz following fault clearance – in excess of 1,000 MW across the mainland NEM – so this event also highlights how the total contingency size will increase as DPV generation displaces large-scale resources which are able to successfully ride through more severe frequency disturbances.

5.3.2 Future UFLS screening study results

Table 23 and Table 24 show the assessment of all future simulations against the acceptance criteria detailed in Section 4.3. Appendix A5 contains the detailed results for each historical case and contingency.

A standard set of 11 future dispatches were studied for each contingency. The key parameters of each of the future dispatch studies are detailed in Appendix A4.

⁷⁵ See <https://aemo.com.au/en/initiatives/major-programs/nem-distributed-energy-resources-der-program/standards-and-connections/compliance-of-der-with-technical-settings>.

⁷⁶ See https://aemo.com.au/-/media/files/electricity/nem/market_notices_and_events/power_system_incident_reports/2024/preliminary-report---loss-of-moorabool---sydenham-500-kv-lines-on-13-feb-2024.pdf?la=en.

Table 23 Future study results summary against acceptance criteria

Case	Contingency 1	Contingency 2	Contingency 3	Contingency 4	Contingency 5	Contingency 6	Contingency 7	Contingency 8	Contingency 9	Contingency 10	Contingency 11
1	✔, QLD freq nadir = 48.2 Hz	✔, NEM freq nadir = 49.4 Hz	✔, NEM freq nadir = 49.4 Hz	✔, NEM freq nadir = 49.4 Hz	✔, NEM freq nadir = 48.9 Hz	✔, NEM freq nadir = 49.3 Hz	✔, NEM freq nadir = 48.4 Hz	✔, NEM freq nadir = 49.5 Hz	✔, NEM freq nadir = 49.6 Hz	✔, NEM freq nadir = 49.2 Hz	✔, QLD freq nadir = 48.2 Hz
2	✔, NEM freq nadir = 49.2 Hz	✔, NEM freq nadir = 48.5 Hz	✔, NEM freq nadir = 48.5 Hz	✔, NEM freq nadir = 48.4 Hz	✘, NEM freq nadir = 47.5 Hz	✔, NEM freq nadir = 48.8 Hz	✔, NEM freq nadir = 48.7 Hz	✔, NEM freq nadir = 48.8 Hz	✔, NEM freq nadir = 48.8 Hz	✔, NEM freq nadir = 48.6 Hz	✔, NEM freq nadir = 49.2 Hz
3	✔, NEM freq nadir = 49.4 Hz	✔, NEM freq nadir = 48.8 Hz	✔, NEM freq nadir = 48.4 Hz	✔, NEM freq nadir = 48.3 Hz	✘, NEM freq nadir = 48 Hz	✔, NEM freq nadir = 49.2 Hz	✔, NEM freq nadir = 48.6 Hz	✔, NEM freq nadir = 48.7 Hz	✔, NEM freq nadir = 48.8 Hz	✔, NEM freq nadir = 48.7 Hz	✔, NEM freq nadir = 48.3 Hz
4	✔, NEM freq nadir = 49 Hz	✔, NEM freq nadir = 48.6 Hz	✔, NEM freq nadir = 48.6 Hz	✔, NEM freq nadir = 48.5 Hz	✔, NEM freq nadir = 48.2 Hz	✔, NEM freq nadir = 48.7 Hz	✔, NEM freq nadir = 48.3 Hz	✔, NEM freq nadir = 48.5 Hz	✔, NEM freq nadir = 48.9 Hz	✔, NEM freq nadir = 48.7 Hz	✔, NEM freq nadir = 48.9 Hz
5	✔, NEM freq nadir = 49.4 Hz	✔, NEM freq nadir = 48.8 Hz	✔, NEM freq nadir = 48.8 Hz	✔, NEM freq nadir = 48.6 Hz	✔, NEM freq nadir = 48.3 Hz	✔, NEM freq nadir = 48.9 Hz	✔, NEM freq nadir = 48.8 Hz	✔, NEM freq nadir = 48.8 Hz	✔, NEM freq nadir = 48.9 Hz	✔, NEM freq nadir = 48.9 Hz	✔, NEM freq nadir = 48.3 Hz
6	✔, NEM freq nadir = 49.3 Hz	✔, NEM freq nadir = 48.7 Hz	✔, NEM freq nadir = 48.7 Hz	✔, NEM freq nadir = 48.8 Hz	✔, NEM freq nadir = 48.2 Hz	✔, NEM freq nadir = 48.8 Hz	✔, NEM freq nadir = 48.5 Hz	✔, NEM freq nadir = 48.9 Hz	✔, NEM freq nadir = 48.9 Hz	✔, NEM freq nadir = 48.9 Hz	✔, NEM freq nadir = 49.3 Hz
7	✔, NEM freq nadir = 49.5 Hz	✔, NEM freq nadir = 48.9 Hz	✔, NEM freq nadir = 48.9 Hz	✔, NEM freq nadir = 48.8 Hz	✔, NEM freq nadir = 48.6 Hz	✔, NEM freq nadir = 49.1 Hz	✔, NEM freq nadir = 48.8 Hz	✔, NEM freq nadir = 49 Hz	✔, NEM freq nadir = 49.1 Hz	✔, NEM freq nadir = 48.9 Hz	✔, NEM freq nadir = 49.5 Hz
8	✔, NEM freq nadir = 49.7 Hz	✔, NEM freq nadir = 49.8 Hz	✔, NEM freq nadir = 49.5 Hz	✔, NEM freq nadir = 49.4 Hz	✔, NEM freq nadir = 49.3 Hz	✔, NEM freq nadir = 49.5 Hz	✔, NEM freq nadir = 48.9 Hz	✔, NEM freq nadir = 48.9 Hz	✔, NEM freq nadir = 49 Hz	✔, NEM freq nadir = 49.7 Hz	✔, NEM freq nadir = 48.6 Hz
9	✔, NEM freq nadir = 49.7 Hz	✔, NEM freq nadir = 49.6 Hz	✔, NEM freq nadir = 49.7 Hz	✔, NEM freq nadir = 49.5 Hz	✔, NEM freq nadir = 49.3 Hz	✔, NEM freq nadir = 49.5 Hz	✔, NEM freq nadir = 49.2 Hz	✔, NEM freq nadir = 49.7 Hz	✔, NEM freq nadir = 48.8 Hz	✔, NEM freq nadir = 49.7 Hz	✔, NEM freq nadir = 48.5 Hz
10	✔, QLD freq nadir = 48.2 Hz	✔, NEM freq nadir = 49.6 Hz	✔, NEM freq nadir = 49.4 Hz	✔, NEM freq nadir = 49.3 Hz	✔, NEM freq nadir = 49.1 Hz	✔, NEM freq nadir = 49.6 Hz	✔, NEM freq nadir = 48.5 Hz	✔, NEM freq nadir = 49.4 Hz	✔, NEM freq nadir = 49.5 Hz	✔, NEM freq nadir = 49.7 Hz	✘, QLD freq nadir = 48 Hz
11	✔, NEM freq nadir = 49.4 Hz	✔, NEM freq nadir = 49 Hz	✔, NEM freq nadir = 48.9 Hz	✔, NEM freq nadir = 48.8 Hz	✔, NEM freq nadir = 48.8 Hz	✔, NEM freq nadir = 49 Hz	✔, NEM freq nadir = 49.1 Hz	✔, NEM freq nadir = 48.8 Hz	✔, NEM freq nadir = 48.9 Hz	✔, NEM freq nadir = 48.8 Hz	✔, NEM freq nadir = 49.3 Hz

Table 24 Future study results summary against acceptance criteria

Case	Generation trip = 40% of op demand	Generation trip = 60% of op demand
1	Contingency size: 5,400 (12,614 MWs) NEM freq nadir (Hz): 48.1 NEM RoCoF (Hz/s): 2.66 NEM net UFLS tripped (MW): 4,016 (50%) NEM DPV tripped on protection (MW): 1,724	Contingency size: 8,090 (16,713 MWs) NEM freq nadir (Hz): 48 NEM RoCoF (Hz/s): 2.66 NEM net UFLS tripped (MW): 4,291 (53%) NEM DPV tripped on protection (MW): 1,526
2	Contingency size: 4,930 (17,023 MWs) NEM freq nadir (Hz): 48.5 NEM RoCoF (Hz/s): 1.88 NEM net UFLS tripped (MW): 3,524 (41%) NEM DPV tripped on protection (MW): 1,458	Contingency size: 7,390 (18,680 MWs) NEM freq nadir (Hz): 48.5 NEM RoCoF (Hz/s): 1.08 NEM net UFLS tripped (MW): 3,018 (31%) NEM DPV tripped on protection (MW): 1,582
3	Contingency size: 4,300 (9,774 MWs) NEM freq nadir (Hz): 48.6 NEM RoCoF (Hz/s): 1.32 NEM net UFLS tripped (MW): 2,370 (22%) NEM DPV tripped on protection (MW): 1,831	Contingency size: 6,463 (7,806 MWs) NEM freq nadir (Hz): 48 NEM RoCoF (Hz/s): 2.24 NEM net UFLS tripped (MW): 3,876 (48%) NEM DPV tripped on protection (MW): 1,432
4	Contingency size: 6,822 (8,946 MWs) NEM freq nadir (Hz): 48.3 NEM RoCoF (Hz/s): 1.86 NEM net UFLS tripped (MW): 4,583 (40%) NEM DPV tripped on protection (MW): 595	Contingency size: 10,200 (19,344 MWs) NEM freq nadir (Hz): 47.7 NEM RoCoF (Hz/s): 2.52 NEM net UFLS tripped (MW): 7,582 (75%) NEM DPV tripped on protection (MW): 567
5	Contingency size: 5,540 (10,646 MWs) NEM freq nadir (Hz): 48.7 NEM RoCoF (Hz/s): 1.09 NEM net UFLS tripped (MW): 3,009 (30%) NEM DPV tripped on protection (MW): 1,550	Contingency size: 8,430 (18,292 MWs) NEM freq nadir (Hz): 47.7 NEM RoCoF (Hz/s): 2.66 NEM net UFLS tripped (MW): 4,711 (52%) NEM DPV tripped on protection (MW): 1,456
6	Contingency size: 5,306 (10,646 MWs) NEM freq nadir (Hz): 48.4 NEM RoCoF (Hz/s): 1.98 NEM net UFLS tripped (MW): 3,500 (45%) NEM DPV tripped on protection (MW): 1,356	Contingency size: 7,960 (10,646 MWs) NEM freq nadir (Hz): 48.3 NEM RoCoF (Hz/s): 1.47 NEM net UFLS tripped (MW): 3,971 (53%) NEM DPV tripped on protection (MW): 1,459
7	Contingency size: 7,030 (10,646 MWs) NEM freq nadir (Hz): 0.82 NEM RoCoF (Hz/s): 48.7 NEM net UFLS tripped (MW): 3,627 (31%) NEM DPV tripped on protection (MW): 1,153	Contingency size: 1,0540 (19,387 MWs) NEM freq nadir (Hz): 1.82 NEM RoCoF (Hz/s): 48.3 NEM net UFLS tripped (MW): 5,630 (56%) NEM DPV tripped on protection (MW): 1,225
8	Contingency size: 5,373 (8,162 MWs) NEM freq nadir (Hz): 48.4 NEM RoCoF (Hz/s): 2.15 NEM net UFLS tripped (MW): 2,255 (35%) NEM DPV tripped on protection (MW): 1,423	Contingency size: 8,060 (16,593 MWs) NEM freq nadir (Hz): 48.2 NEM RoCoF (Hz/s): 1.31 NEM net UFLS tripped (MW): 3,694 (56%) NEM DPV tripped on protection (MW): 1,267
9	Contingency size: 4,950 (8,680 MWs) NEM freq nadir (Hz): 48.8 NEM RoCoF (Hz/s): 1.26 NEM net UFLS tripped (MW): 2,615 (19%) NEM DPV tripped on protection (MW): 1,704	Contingency size: 7,425 (7,023 MWs) NEM freq nadir (Hz): 48.5 NEM RoCoF (Hz/s): 1.33 NEM net UFLS tripped (MW): 3,978 (43%) NEM DPV tripped on protection (MW): 1,430

Case	Generation trip = 40% of op demand	Generation trip = 60% of op demand
10	Contingency size: 5,650 (13,397 MWs) NEM freq nadir (Hz): 48.6 NEM RoCoF (Hz/s): 1.54 NEM net UFLS tripped (MW): 3,388 (33%) NEM DPV tripped on protection (MW): 1,679	Contingency size: 8,470 (21,044 MWs) NEM freq nadir (Hz): 47.6 NEM RoCoF (Hz/s): 3.57 NEM net UFLS tripped (MW): 5,979 (59%) NEM DPV tripped on protection (MW): 1,229
11	Contingency size: 9,030 (8,162 MWs) NEM freq nadir (Hz): 48.3 NEM RoCoF (Hz/s): 0.96 NEM net UFLS tripped (MW): 6,397 (48%) NEM DPV tripped on protection (MW): 983	Contingency size: 13,540 (18,561 MWs) NEM freq nadir (Hz): 47.8 NEM RoCoF (Hz/s): 2.02 NEM net UFLS tripped (MW): 9,312 (71%) NEM DPV tripped on protection (MW): 1,298

Key findings

The future UFLS screening studies identified the following key findings in relation to the stated acceptance criteria:

- Studies completed by AEMO as part of the 2024 GPSRR indicated that, for most of the possible significant multiple frequency events not resulting in regional separation assessed, there is sufficient EUFR available across the mainland NEM regions to arrest system frequency. However, the studies also showed that there may not be sufficient under frequency reserves to arrest the impacts of the very severe multiple contingency events affecting 60% of the total power system load (NER 4.3.1(k)).
 - For many of the future dispatches studied, the mainland NEM frequency fell below 48 Hz when generation corresponding to 60% of the total mainland NEM operational demand was tripped.
 - The amount of generation that was tripped was evenly spread across the mainland NEM regions to limit the chance that regional interconnectors lost stability.
 - The impact of tripping generation corresponding to 60% of mainland operational demand depended on how much synchronous generation/inertia was tripped, as well as the timing of the multiple trips.
 - As a result of the points detailed above, it is difficult to simulate the tripping of such a large amount of generation.
- Considering other less onerous and more probable significant multiple contingency events, NEM frequency only fell below 48 Hz for two of the cases studied following contingency 5 (see Table 10 in Section 4.1.3). This was primarily due to QNI losing stability and the resultant additional loss of generation following the separation of Queensland.
- The anticipated large-scale BESS, particularly in New South Wales (which has the largest anticipated aggregated installed capacity and is centrally located in the NEM), contributed significantly to the arrest of frequency in significant multiple contingency events, with previous AEMO studies indicating that 1 MW of BESS headroom delivering primary frequency response would be approximately equivalent to 1 MW of UFLS net load trip⁷⁷.

⁷⁷ See https://aemo.com.au/-/media/files/stakeholder_consultation/consultations/nem-consultations/2022/psfrr/non-credible-separation-of-south-australia.pdf?la=en&hash=1F1702974B14DC704FB964C7A25E8645.

- As detailed in Appendix A4, most future dispatches that were selected are daytime cases with high levels of regional DPV generation and low operational demand, as this results in low UFLS availability. However, based on the ISP market modelling data, most of these dispatches also have large levels of fast frequency response (FFR) headroom, as regional large-scale BESS are charging due to the low demand conditions. This FFR headroom provided significant frequency support for the different multiple contingency events studied, thereby reducing the reliance of the power system on UFLS availability.
- Sensitivities were completed with reduced FFR BESS headroom available in New South Wales. Results indicated that, as expected, the power system frequency response was degraded if the available UFLS was exhausted. Additionally, without the BESS raise capability in New South Wales, it was observed that QNI was more likely to lose stability following the loss of generation south of Queensland for high Queensland export conditions – for the Case 2 sensitivity, southern NEM frequency collapsed following QNI separation.
- The frequency droop setting of the anticipated regional large-scale BESS also impacted the NEM RoCoF and system frequency performance following contingency events. As detailed in Appendix A4, for the 2024 GPSRR future UFLS studies, a conservative droop setting of 1.9% was assumed.
- It is important to note that the location of large-scale BESS greatly impacts power system stability, as fast discharging/charging in response to remote frequency disturbances could cause large swings on interconnectors.
- The study results showed that following separation, Queensland frequency could collapse when Queensland is importing where the available UFLS is insufficient.
 - This finding reinforced an existing recommendation from the 2022 PSFRR and 2023 GPSRR for Powerlink and Energy Queensland to identify and implement measures to restore UFLS load, and to collaborate with AEMO on the design and implementation of remediation measures.
- Consistent with the historical UFLS screening study results, it was observed that QNI can lose stability following large generation contingencies south of Queensland for high Queensland export conditions, and large generation contingencies in Queensland for high Queensland import conditions.
- For all future dispatches and contingencies except Case 10, the mainland NEM and Queensland RoCoF remained below 3 Hz/s.
 - For Case 10, following the loss of QNI and Callide units, Queensland RoCoF reached 3.2 Hz if QNI and the Callide units were tripped simultaneously. For Case 10, there was high import into Queensland over QNI and high Callide generation, resulting in a low frequency nadir in Queensland (47.7 Hz) and a high Queensland RoCoF. If the Callide generation was tripped 1 s after QNI, the maximum Queensland RoCoF was reduced to 2.4 Hz/s.
 - At RoCoF higher than 3 Hz/s, there is low confidence that EFCs will operate properly to arrest a disturbance⁷⁸.

⁷⁸ AEMO (2022) AEMO Advice: Reliability Panel Review of Frequency Operating Standard, Section 3.2, <https://www.aemc.gov.au/sites/default/files/2022-12/AEMO%20FOS%20advice%20to%20the%20Reliability%20Panel%20FINAL%20for%20Publishing%20221205.pdf>.

- Following the commissioning of PEC Stage 2, Queensland is the mainland region most at risk of non-credible islanding. AEMO therefore recommends that a RoCoF constraint similar to what is currently in place for South Australia be considered for the Queensland region if there is a substantial reduction in regional inertia.

Other observations

Additional observations that do not impact the acceptance criteria are outlined below:

- For several cases, a significant amount of DPV was tripped on inverter settings due to the system frequency falling below 49 Hz following fault clearance – in excess of 1,000 MW across the mainland NEM – so these studies also highlight how the total contingency size will increase as large-scale resources which are able to successfully ride through more severe frequency disturbances are displaced by DPV generation.

Recommendation 3

AEMO recommends that NSPs outside South Australia, in conjunction with AEMO, investigate (and implement wherever possible) low-cost measures, such as dynamic arming, to restore UFLS availability in addition to the existing and planned projects/initiatives detailed in Section 6.2 and Section 6.3. Based on the future FY 2028-29 studies completed as part of the 2024 GPSRR, there will be times of inadequate under frequency reserves across mainland NEM regions to arrest frequency for the significant multiple contingency events considered.

AEMO also recommends that the proposed low-cost Victoria Stage 1 UFLS actions to increase UFLS availability be implemented urgently to reduce risk prior to the commissioning of PEC Stage 2, for the non-credible loss of the Victoria – New South Wales Interconnector (VNI).

2022 PSFRR recommendation

The 2024 GPSRR future UFLS screening studies reinforce an existing recommendation from the 2022 PSFRR for Powerlink and Energy Queensland to identify and implement measures to restore UFLS load, and to collaborate with AEMO on the design and implementation of remediation measures. Therefore, further remediation should be implemented in addition to the already planned initiatives detailed in Section 6.3, such as the review of UFLS settings for large industrial loads.

Review of the QNI UFLS inhibit scheme

Studies completed by AEMO as part of the 2024 GSPRR indicate that the QNI inhibit scheme is ineffective at preventing QNI instability for remote frequency disturbances south of Queensland for the majority of Queensland export conditions. Therefore, AEMO recommends that AEMO, in consultation with Powerlink, review this scheme given the changes in NEM dispatches, Queensland UFLS availability and QNI flows, in particular following the completion of the QNI minor upgrade. This review should be co-ordinated with the development of any future QNI SPS in consultation with AEMO, Transgrid, AVP and Powerlink.



Evaluating post PEC-1 operational mitigations for non-credible loss of Heywood

There is currently a constraint which limits import into South Australia over the Heywood interconnector based on the net UFLS load, DPV generation, power system inertia and the availability of Fast Active Power Response (FAPR).

There is also currently a constraint set in place to maintain South Australia RoCoF below 2 Hz/s immediately following the non-credible loss of the Heywood interconnector, which was introduced to meet the requirements of under regulation 88A of the Electricity (General) Regulations 2012 (SA).

Recommendation 5

Given PEC Stage 1 will be inter-tripped for the non-credible loss of the Heywood interconnector, these constraints will remain in place following commissioning of PEC Stage 1.

5.3.3 UFLS screening studies results summary

Table 25 shows a summary of the key findings and recommendations from the ULFS screening studies for each region. The summary table shows the results of both historical and future looking studies and provides an overview of the events assessed and generation lost as a percentage of operational demand.



Table 25 UFLS screening studies results summary

Regions Impacted	Events assessed (max gen lost as % operational demand)	Key Finding	Recommendation	
			Previous	New
NEM intact	Multiple station trip (up to 60%)	<ul style="list-style-type: none"> The existing NEM UFLS availability was sufficient to arrest frequency for all of the assessed plausible significant multiple contingency events (defined in Section 4.1.3) not resulting in regional separation (NEM intact). Studies for FY 2028-29 show that there are scenarios where there is insufficient under frequency reserves across mainland NEM regions to arrest the impacts of the severe multiple contingency events affecting up to 60% of the total power system load studied, resulting in frequency collapse. For FY 2028-29, the anticipated large-scale BESS capacity, particularly in New South Wales, contributes significantly to the arrest of frequency in significant multiple contingency events. Therefore, the frequency response is heavily dependent on the amount of large-scale BESS headroom available. 	<ul style="list-style-type: none"> Refer to Section 6.2 and Section 6.3 for existing and planned remediation projects for all NEM regions. 	<ul style="list-style-type: none"> AEMO recommends that NSPs outside South Australia, in conjunction with AEMO, investigate (and implement wherever possible) low-cost measures, such as dynamic arming, to restore UFLS availability in addition to the existing and planned initiatives detailed in Section 6.2 and Section 6.3. As NSPs work to restore UFLS availability to meet the requirements of NER 4.3.1(k).
South Australia	SA separation + TIPS B + Pelican Point trip (up to 50%)	<ul style="list-style-type: none"> Based on the cases studied, South Australia UFLS and large-scale BESS availability is not adequate to arrest the frequency decline for South Australia after separation and the loss of two stations for some South Australia import dispatch conditions. The minimum South Australia frequency nadir observed was 47.3 Hz for case 14. 	<ul style="list-style-type: none"> South Australia separation was not the focus of the 2024 GPSRR UFLS screening studies, as the South Australia EUFR requirement was assessed as part of a separate AEMO report⁷⁹. AEMO proposed a EUFR target for South Australia up until the commissioning of PEC Stage 2 that is the maximum of either 700 MW or 60% of operational demand. This would be sufficient to manage the four multiple contingency events studied ~80% of the time, delivering a similar risk profile to historical levels of coverage via traditional UFLS. The rollout of dynamic arming of UFLS in South Australia, and the extra battery headroom now available in South Australia, means that this target is expected to be met ~99.8% of the time, with no further actions. This delivers a similar level of residual risk to historical levels. 	
Queensland	QLD separation + Millmerran plants trip (up to 40%)	<ul style="list-style-type: none"> 2024 GPSRR studies showed that Queensland UFLS availability is currently adequate to arrest Queensland frequency for significant events involving Queensland separation followed by the loss of multiple units for Queensland import conditions. 	<ul style="list-style-type: none"> The 2022 PSFRR and 2023 GPSRR recommended that Powerlink and Energy Queensland identify and implement measures to restore UFLS load, and to collaborate with 	<ul style="list-style-type: none"> The results from the 2024 GPSRR highlight the need for continued remediation of UFLS in QLD in addition to the current planned initiatives, such as the review of UFLS settings for large industrial loads.

⁷⁹ AEMO (May 2024), *Emergency Under Frequency Response for South Australia*, <https://aemo.com.au/-/media/files/initiatives/der/2024/2024-05-21-emergency-underfrequency-requirements-for-south-australia.pdf?la=en&hash=200839621941320C557B67B6DC4DF59A>

Regions Impacted	Events assessed (max gen lost as % operational demand)	Key Finding	Recommendation	
			Previous	New
		<ul style="list-style-type: none"> The minimum Queensland frequency nadir observed was 48.7 Hz for case 1. 	AEMO on the design and implementation of remediation measures.	
Victoria / South Australia	VNI separation + Loy Yang A plants trip (up to 50%)	<ul style="list-style-type: none"> 2024 GPSRR studies showed that Victoria and South Australia EUFR availability is currently adequate to arrest frequency for significant events involving the loss of VNI followed by the loss of multiple units for Victoria/South Australia import conditions. However, based on the projection of Victoria UFLS for FY 2028-29, total Victoria aggregate UFLS availability could be close to 0 MW for some daytime operating conditions. This could pose a significant risk prior to the commissioning of PEC Stage 2 at times of coincident low UFLS availability in South Australia, for the non-credible loss of VNI. The minimum Victoria/South Australia frequency nadir observed was 48.3 Hz for case 15. 	<ul style="list-style-type: none"> Refer to Section 6.2 and Section 6.3 for details of all current and planned Victoria UFLS remediation projects. 	<ul style="list-style-type: none"> AEMO recommends that the proposed low-cost Victoria Stage 1 UFLS actions to increase UFLS availability are implemented urgently.

5.4 PEC Stage 1 destructive wind limit studies

The response of the South Australian system was assessed for a variety of multiple contingency events involving the disconnection of over 500 MW of generation – refer to Section 4.2 for details of the study methodology.

Table 26 shows the assessment of all simulations against the acceptance criteria detailed above. The key parameters of each of the base cases are detailed in Table 13 in Section 4.2.5.

The sensitivity study results varying contingency size are summarised in Table 27, and key findings and observations from the assessments are summarised after the tables.

Table 26 PEC Stage 1 destructive wind limit study base case results

Case	Contingency 1 – Loss of TIPS B Unit 2	Contingency 2 – Loss of 500 MW synchronous generation	Contingency 3 – Loss of 500 MW asynchronous generation
1	✓	✓	✓
2	✓	✓	✓
3	✓	✗ Unstable – voltage instability. High DPV and low load resulted in additional 300 MW contingency size. Interconnector satisfactory limits exceeded.	✓ Only just on the satisfactory interconnector limits. Case marginally stable due to reduced DPV tripping as a result of the more remote fault.
4	✓	✗ Interconnector limits exceeded but marginally stable. Compared with Case 3, the additional 125 MW headroom on interconnectors was sufficient to remain stable.	✓
5	✓	✗ Unstable – voltage instability. Satisfactory interconnector limits exceeded.	✗ Unstable – voltage instability. Satisfactory interconnector limits exceeded.
6	✓	✓	✓
7	✓	✗ Stable but satisfactory interconnector limits exceeded.	✗ Stable but satisfactory interconnector limits exceeded.
8	✓	✗ Unstable – voltage instability. This case is Case 5 with more DPV, so it was to be expected this would be more unstable due to a larger total contingency size.	✗ Unstable – voltage instability. This case is Case 5 with more DPV, so it was to be expected this would be more unstable due to a larger total contingency size.
9	✓	✓	✓

Case	Contingency 1 – Loss of TIPS B Unit 2	Contingency 2 – Loss of 500 MW synchronous generation	Contingency 3 – Loss of 500 MW asynchronous generation
10	☑	☒ This is the same as Case 7 but with very high DPV. Unstable as expected due to voltage instability and interconnector satisfactory limits exceeded.	☒ Unstable as expected due to voltage instability and interconnector satisfactory limits exceeded.
11	☑	☑	☑
12	☑	☑	☑
13	☑	☑	☑
14	☑	☑	☑
15	☑	☑	☑
16	☑	☑	☑

Table 27 Contingency size sensitivity study results

Case	SA load (MW)		SA DPV (%)	Inertia (MWs)			HIC flow (MW)	PEC flow (MW)	Initial Contingency size (MW)	Total contingency size (+DPV and load trip) (MW)	Pass/fail	Comment
2c5	1,973	40	5,757	430	70	500	587	Fail	Stable, but HIC limit exceeded			
5c7	2,590	15	5,333	430	70	700	631	Fail	HIC and PEC limits exceeded			
5c17	2,590	15	11,000	430	70	700	646	Fail	HIC and PEC limits exceeded			
10c5	2,109	60	5,333	430	70	500	>650	Fail	Unstable and exceeded HIC and PEC limits			

HIC: Heywood interconnector.

Key findings

The studies regarding the PEC Stage 1 destructive wind limits resulted in the following key findings in relation to the stated acceptance criteria:

- For the base cases studied, the existing satisfactory limits of the Heywood and PEC interconnectors were reached before voltage instability or angular instability was observed for 500 MW contingency sizes. These satisfactory limits are 850 MW for Heywood and 250 MW for PEC Stage 1.
- The effects of tripping of DPV and load as a result of the fault can significantly impact the effective total contingency size. For cases with high DPV online and low load, it can cause the total contingency size to increase significantly.
 - In this modelling, it was confirmed that faults closer to the Adelaide metropolitan area were more severe and can result in more of the online DPV tripping. This is aligned with AEMO’s experience of real events and is discussed in more detail in Appendix A5.

- However, given that destructive wind conditions often coincide with stormy conditions and cloud cover, it is unlikely that the destructive winds constraints will need to be invoked during high DPV generation operating conditions. Additionally, load shake-off also occurs as a result of contingency events, which offsets the DPV shake-off and reduces the total effective generation contingency size.
- To ensure that the interconnector satisfactory limits are maintained, the destructive wind transfer limits should be reduced in high DPV generation scenarios or in any other scenario that may make larger contingency sizes more likely. Studies demonstrated that both DPV and load would both disconnect as a result of the fault, resulting in contingency size increases of up to 200 MW or more. Across a variety of dispatch scenarios, this was approximately equal to 10% of the online DPV generation.
- It was determined considering the factors detailed above, that a negative offset be added to the South Australia destructive wind limits equal to 10% of the online South Australia DPV generation to ensure that an increase in the effective contingency size due to DPV shake-off does not result in the satisfactory limits of the interconnectors being exceeded. Based on the current level of installed DPV generation in South Australia, this offset could range from 0 MW to 240 MW depending on the DPV generation capacity factor/level of DPV generation online. Figure 9 shows the impact this offset would have on the South Australia total destructive winds interconnector limits.
- Reducing the pre-contingent flow over the interconnectors maintained stability of the network for a consistent total contingency size. Cases that were previously unstable in the initial base case studies could be made stable by reducing the pre-contingent flow over the interconnectors to the proposed limits. This is discussed in more detail in Appendix A5.
- Constraining the pre-contingent interconnector flows to the proposed limits of 430 MW for Heywood and 70 MW for PEC, a range of contingency sizes were applied and it was found that the existing satisfactory limits of the interconnectors were reached before instability was observed in the network.
 - For a 500 MW total contingency size or smaller, the Heywood and PEC satisfactory limits were maintained when the limits of 430 MW for Heywood and 70 MW for PEC were used, and there was still at least 100 MW of headroom to allow for interconnector drift.
 - For each of the four contingency size sensitivity cases studied (refer to Table 27), the interconnector satisfactory limits for Heywood and PEC Stage 1 were exceeded for total contingency sizes of approximately 600 MW or above. This means that if interconnector destructive wind limits of 430 MW for Heywood and 70 MW for PEC are introduced, the total contingency size should be contained to 500 MW or below to ensure that the satisfactory limits are not exceeded post-contingency.
 - To account for a larger expected contingency size of 600 MW, an additional 100 MW margin is required to ensure that the satisfactory limits of Heywood and PEC Stage 1 are not exceeded.
 - The next limit that was reached after the Heywood and PEC Stage 1 satisfactory limits were exceeded was the voltage stability limit. It was found that importing large amounts of power over the interconnectors resulted in large reactive power swings and large, undamped voltage oscillations throughout the network. For low system strength cases, the online machines and SVCs reached their reactive limits, which contributed to the voltage instability.

- For very large contingency sizes, angular separation was possible. However, this involved the loss of 900-1,000 MW in South Australia in the cases studied.
- An additional 100 MW of margin is proposed to be added to the transfer limits to account for increasing online wind and the risk of larger contingency sizes. Due to this, the proposed limits of 430 MW for Heywood and 70 MW for PEC should be decreased to 350 MW on Heywood and 50 MW on PEC Stage 1 (see Section 4.2.4).
- Additional synchronous machines online assist in the stability of the system post-contingency. The voltage response of the system was improved as more synchronous machines were brought online, further reducing the likelihood of voltage instability in the network – this is detailed further in Appendix A5.

Figure 9 South Australia total destructive winds import limit versus South Australia DPV generation

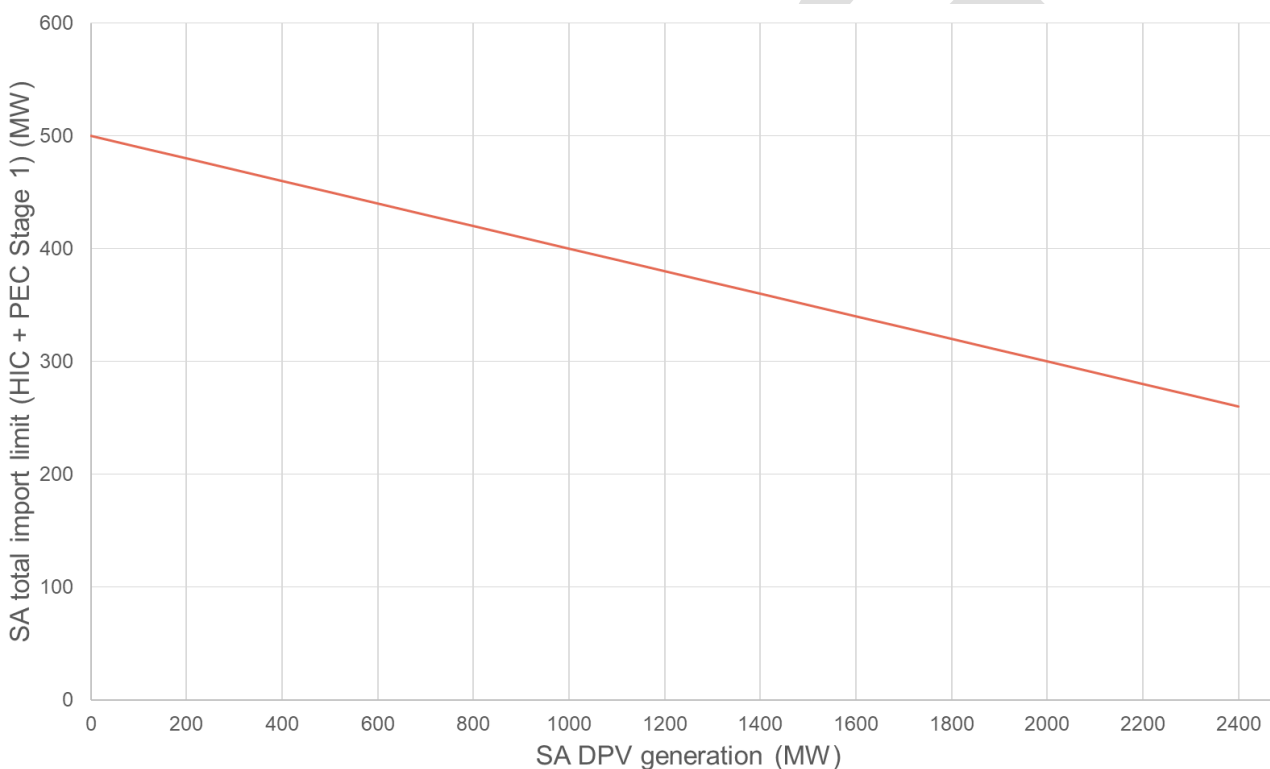

Other observations

- The studies were undertaken assuming that WAPS was not in service. With correct operation of WAPS when it is in service, it is expected that the battery response and load tripping would reduce flow over the interconnectors to further reduce risk of instability. With WAPS in service, the system may be able to withstand contingency sizes of up to 600 MW above the response provided by WAPS, but this would need to be confirmed with additional studies.
- Delayed or staggered tripping of generation resulted in similar or improved system stability compared to tripping all generation simultaneously. Due to this, simultaneous tripping was studied as the base case to understand the limits. If staggered tripping occurs, post fault system stability is expected to improve.
- Adjusting the angle of the PEC phase shifting transformer (PST) to vary the ratio of flow over Heywood and PEC did not significantly improve or degrade stability outcomes.

The limits defined here in the 2024 GPSRR apply for destructive wind conditions that could result in the loss of multiple transmission elements causing generation disconnection in South Australia to reduce the likelihood of South Australia islanding. This is separate to the South Australia import constraints that are invoked for destructive wind conditions impacting Heywood where South Australia islanding is reclassified as credible. As PEC Stage 1 will be inter-tripped with Heywood, the South Australia destructive wind transfer import limit for the credible loss of Heywood will remain at 250 MW.

Through studies completed in the 2024 GPSRR, AEMO has determined that after the commissioning and interconnector testing of PEC Stage 1 is completed destructive wind transfer limits into South Australia of 350 MW for Heywood and 50 MW for PEC Stage 1 will mitigate the risk of exceeding the satisfactory South Australia interconnector limits for a nominal 600 MW South Australia generation contingency size. These limits also allow for up to 100 MW of interconnector drift.

AEMO has identified that DPV generation shake-off in response to power system faults can further increase the total South Australia contingency size. To account for this impact, AEMO will dynamically reduce the stated maximum destructive wind transfer limits by 10% of the online South Australia DPV generation.

Note that the limits stated above assume system normal conditions and the full capacity of Heywood and PEC Stage 1. If there are significant system outages or other constraints that limit the effective capacity of Heywood or PEC Stage 1, the destructive wind transfer limits will be reduced accordingly. If PEC Stage 1 is out of service or constrained to 0 MW, the existing 250 MW interconnector limit into South Australia will apply.

The previous South Australia destructive winds protected event required AEMO to take steps to actively manage the risk that, during periods of forecast destructive wind conditions in South Australia, the loss of multiple transmission elements could cause up to 500 MW of generation to disconnect in South Australia (being a contingency that is assumed to be reasonably possible when destructive winds are forecast). Since 2019, the system dispatch and operating conditions in South Australia have changed due to several different factors, which impact the appropriate nominal contingency size considered in determining the destructive wind limits. As discussed further in Section 4.2.4, AEMO has determined as part of its analysis that an increased nominal contingency size of 600 MW should be used to calculate the destructive wind limits. The nominal contingency size used to calculate the destructive wind limits will be reviewed following any major changes in the South Australia system or operational conditions.

6 Review of risk management measures

In addition to the evaluation of the selected priority high impact events, the GPSRR also provides an overview of risk mitigation measures encompassing existing EFCSSs, operational capabilities and other emerging risks in the context of an evolving power system.

6.1 OFGS review

OFGS schemes operate to trip generators for over frequency events. At present, OFGS schemes are in operation in Tasmania, South Australia and Western Victoria. The following improvements are being pursued or planned to improve OFGS operation in different regions:

- South Australian and Western Victoria OFGS – ElectraNet has implemented updated settings with approximately half of the required participants in South Australia. AVP has implemented updated settings with a generator in South West Victoria, other generator settings may also be updated through ongoing operational improvement.
- Queensland OFGS – AEMO has identified a requirement to implement an OFGS in Queensland to help mitigate over frequency events, such as those due to QNI tripping. AEMO is working in consultation with Powerlink on the design, which is planned for completion by Q3 2024. Following the detailed design, AEMO will cooperate with Powerlink as needed on the procurement, implementation, and commissioning schedule.
- AEMO will continue to assess the potential need for OFGS in New South Wales and Victoria (east of Moorabool).

6.2 Emergency under frequency management

UFLS is a last resort “safety net”, designed to prevent black system events when severe (non-credible) generation contingencies occur. It involves the automatic disconnection of load circuits to rebalance supply and demand.

Increasing levels of generation from DPV are reducing the load on UFLS circuits, reducing the effectiveness of UFLS. With very high levels of DPV generation, UFLS circuits can operate in reverse flows, which means that in the absence of intervention, UFLS relays will act to disconnect circuits that are net generators (rather than net loads), exacerbating the supply demand imbalance when they activate following an under frequency event.

More information can be found in AEMO reports to NSPs advising on the impacts of DER on net UFLS load in:

- Victoria⁸⁰.
- New South Wales⁸¹.

⁸⁰ AEMO (August 2021) *Phase 1 UFLS Review: Victoria*, <https://aemo.com.au/-/media/files/initiatives/der/2021/vic-ufls-data-report-public-aug-21.pdf?la=en&hash=A72B6FA88C57C37998D232711BA4A2EE>.

⁸¹ AEMO (December 2021) *Phase 1 UFLS Review: New South Wales*, <https://aemo.com.au/-/media/files/initiatives/der/2022/new-south-wales-ufls-scheme.pdf?la=en&hash=D8E106C09B66F9EAC4C6601E068784F0>.

- Queensland⁸².

More information is also available in previous PSFRRs^{83,84,85}.

Table 28 summarises key emergency under frequency management initiatives underway.

Table 28 Summary of mainland NEM regions UFLS remediation projects

Region	Project	Lead	Status
NEM	Determination of Emergency Under Frequency Response (EUFR) requirements for low demand periods	AEMO	<ul style="list-style-type: none"> • Developed and applied methodology to determine EUFR target for South Australia(see further detail below).
	Improved UFLS models	AEMO	<ul style="list-style-type: none"> • Improved integration of UFLS into AEMO’s root mean squared (RMS) models. AEMO created mappings of regional UFLS relays to individual transmission bus locations in the full NEM PSS@E model based on data compiled from NSPs for all mainland NEM regions. This approach most accurately reflects the physical distribution of this type of generation and UFLS in the system. • Improved modelling is necessary to facilitate ongoing work to design and update UFLS settings under emerging novel power system conditions.
South Australia	Dynamic arming ^A of UFLS relays (blocks UFLS activation if circuit is in reverse flow)	SA NSPs	<ul style="list-style-type: none"> • AER approved SA Power Networks cost pass-through application^B. • SA Power Networks implementation is under way (see further detail below), target completion of first phase rollout: 2024. Implementation thus far recovered 307MW out of target 385MW.
	Real time SCADA feed of UFLS load in each band	SA NSPs	<ul style="list-style-type: none"> • Real-time SCADA feed established for total SA UFLS load. • Real-time SCADA updated quarterly as increased visibility with Dynamic Arming functionality is being rolled out. • SA Power Networks is updating capability to provide visibility of load in individual UFLS bands (target completion: Q2 2025)
	Expansion of delayed UFLS scheme	AEMO, SA NSPs	<ul style="list-style-type: none"> • AEMO advice provided to SA Power Networks to expand delayed UFLS^C. • SA Power Networks identification of circuits and implementation underway (target completion: 2024).
Victoria	AEMO advice to NSPs	AEMO	<ul style="list-style-type: none"> • AEMO report provided to NSPs identifying declining load in UFLS due to DPV, and projecting UFLS net load to reach as low as 12% of underlying demand in some periods by late 2023^D. Recommended that NSPs explore rectification options. • Update delivered to NSPs in 2023^E, identifying continuing trend in decline.
	Real time SCADA feed of UFLS load in each band	VIC NSPs	<ul style="list-style-type: none"> • AEMO has established a method for compiling VIC UFLS data from transmission use of system charge (TUoS) metering (for post-hoc analysis). • Further NSP actions required to establish real-time visibility.
	Addressing large wind/solar farms behind UFLS relays	VIC NSPs	<ul style="list-style-type: none"> • AEMO report identified several UFLS circuits in significant reverse flows due to large wind and solar farms connected behind UFLS relays^F. Recommended that NSPs seek rectification.

⁸² AEMO (December 2021) *Phase 1 UFLS Review: Queensland*, <https://aemo.com.au/-/media/files/initiatives/der/2022/queensland-ufls-scheme.pdf?la=en&hash=A451A3AEA814BFBB16CE0AAD185CB7FE>.

⁸³ AEMO (July 2020) 2020 Power System Frequency Risk Review – Stage 1, Appendix A1, https://aemo.com.au/-/media/files/stakeholder_consultation/consultations/nem-consultations/2020/psfrr/stage-1/psfrr-stage-1-after-consultation.pdf?la=en&hash=A57E8CA017BA90B05DDD5BBBB86D19CD.

⁸⁴ AEMO (December 2020) Power System Frequency Risk Review – Stage 2 Final Report, Section 6.2, <https://aemo.com.au/-/media/files/initiatives/der/2020/psfrr-stage-2-final-report.pdf?la=en&hash=9B8FF52E750F25F56665F2BE10EBFDFA>.

⁸⁵ AEMO (July 2022) Power System Frequency Risk Review, Final Report, Section 3.3, https://aemo.com.au/-/media/files/stakeholder_consultation/consultations/nem-consultations/2022/psfrr/2022-final-report--power-system-frequency-risk-review.pdf?la=en&hash=79BE593AE07E51B7E8129210D45840A6.

Region	Project	Lead	Status
			<ul style="list-style-type: none"> AusNet Transmission has developed a rectification proposal and has received approval from AEMO. AER approval required to proceed.
	Connections process updates to account for UFLS	VIC NSPs	<ul style="list-style-type: none"> AEMO report recommended that NSPs update their connections processes to minimise detrimental UFLS impacts for new generator connections^F. Under consideration via the Victorian Electricity Emergency Committee (VEEC).
	Adding new loads to UFLS	VIC NSPs	<ul style="list-style-type: none"> AusNet Transmission has conducted an audit of VIC UFLS and identified “Stage 1” rectification actions, including circuits to be removed from the UFLS (in frequent reverse flows), and circuits to be added to UFLS. Proposed Stage 1 actions have been reviewed and approved by VEEC and VIC DNSPs. AusNet has received approval from AEMO. NSPs progressing AER approval.
	Feasibility study for UFLS provided by advanced metering infrastructure (AMI)	AEMO	<ul style="list-style-type: none"> The feasibility of different options for UFLS remediation, including UFLS at customer AMI, has been analysed using case studies of several archetypal sub-transmission loops. This approach does appear to have technical merit and long term potential, but many areas requiring further investigation were identified. AEMO published a short report on the findings to inform further NSP investigation^G.
New South Wales	AEMO advice to NSPs	AEMO	<ul style="list-style-type: none"> AEMO report provided to NSPs identifying declining load in UFLS due to DPV^H. Recommended NSPs explore rectification options.
	NSP progress on UFLS remediation	NSW NSPs	<ul style="list-style-type: none"> NSPs conducting an audit of NSW UFLS identifying short term remediation actions. NSPs identify metering uplifts required, especially to identify UFLS circuits in reverse power flow. Initial implementation and testing of dynamic arming on limited circuits.
Queensland	AEMO advice to NSPs	AEMO	<ul style="list-style-type: none"> AEMO report provided to NSPs identifying declining load in UFLS due to DPV^I. Recommended NSPs explore rectification options.
	NSP progress on UFLS remediation	QLD NSPs	<ul style="list-style-type: none"> NSPs auditing UFLS scheme, identifying areas of improvement. NSPs identify metering uplifts required, especially to identify UFLS circuits in reverse power flow. Energy Queensland developing dashboard for real time visibility of UFLS load.

A. AEMO (May 2021) *South Australian Under Frequency Load Shedding – Dynamic Arming*, <https://aemo.com.au/-/media/files/initiatives/der/2021/south-australian-ufls-dynamic-arming.pdf?la=en&hash=C82E09BBF2A112ED014F3436A18D836C>.

B. AER (2022) *SA Power Networks – Cost pass through – Emergency standards 2021-22*, <https://www.aer.gov.au/networks-pipelines/determinations-access-arrangements/cost-pass-throughs/sa-power-networks-cost-pass-through-emergency-standards-2021%E2%80%9322>.

C. Further information on AEMO advice on delayed UFLS is provided in 2022 Power System Frequency Risk Review, Section 3.3.3 (July 2022), https://aemo.com.au/-/media/files/stakeholder_consultation/consultations/nem-consultations/2022/psfrr/2022-final-report--power-system-frequency-risk-review.pdf?la=en.

D. AEMO (August 2021) *Phase 1 UFLS Review: Victoria*, <https://aemo.com.au/-/media/files/initiatives/der/2021/vic-ufls-data-report-public-aug-21.pdf?la=en&hash=A72B6FA88C57C37998D232711BA4A2EE>.

E. AEMO (May 2023) *Victoria: UFLS load assessment update*, https://aemo.com.au/-/media/files/stakeholder_consultation/consultations/nem-consultations/2022/psfrr/2023-05-25-vic-ufls-2022-review.pdf?la=en&hash=CFDBA2D60117E8E7FE452B2C2F468B3B.

F. AEMO (August 2021) *Phase 1 UFLS Review: Victoria*, (Section 3.5, Section 4.1), <https://aemo.com.au/-/media/files/initiatives/der/2021/vic-ufls-data-report-public-aug-21.pdf?la=en&hash=A72B6FA88C57C37998D232711BA4A2EE>.

G. AEMO (October 2023) *Under frequency load shedding: Exploring dynamic arming options for adapting to distributed PV*, <https://aemo.com.au/-/media/files/initiatives/der/2023/dynamic-arming-options-for-ufls.pdf?la=en&hash=F6B7A015C8EB872C83513BA9C95EFE5B>.

H. AEMO (December 2021) *Phase 1 UFLS Review: New South Wales*, <https://aemo.com.au/-/media/files/initiatives/der/2022/new-south-wales-ufls-scheme.pdf?la=en&hash=D8E106C09B66F9EAC4C6601E068784F0>.

I. AEMO (December 2021) *Phase 1 UFLS Review: Queensland*, <https://aemo.com.au/-/media/files/initiatives/der/2022/queensland-ufls-scheme.pdf?la=en&hash=A451A3AEA814BFBB16CE0AAD185CB7FE>.

South Australia – Dynamic UFLS arming

Dynamic arming of UFLS in South Australia commenced rollout in October 2022. The project will recover an estimated 385 MW⁸⁶ to the UFLS scheme in South Australia by the time of first phase completion in 2024. It is anticipated that South Australia Power Networks will continue to monitor feeder flows, and maintain suitable coverage of dynamic arming over time, as more feeders pass reverse flow thresholds.

Victoria – UFLS load in historical and projected periods

In 2021, AEMO provided NSPs with advice on declining UFLS load levels in Victoria during 2018, 2019 and 2020, related to increasing levels of DPV⁸⁷. In May 2023, AEMO published updated analysis of UFLS load in Victoria, accounting for continuing growth in DPV during 2021-2023⁸⁸. Key findings from the update are as follows:

- Annual minimum total net load in the Victorian UFLS scheme has decreased from close to 2 GW in 2018 to 1.2 GW in 2022.
- This trend is projected to continue as the installation of DPV continues, with minimum total UFLS load in Victoria projected⁸⁶ to reach close to 870 MW by late 2025, and 576 MW by late 2026 (based on the ISP *Step Change* scenario forecast growth in DPV and change in underlying demand).
- Net UFLS load in Victoria has decreased from a minimum of 45% of underlying demand in 2018, to a minimum of 18% of underlying demand in 2022.

The continued growth in DPV is also leading to an increase in UFLS sub-transmission loops experiencing reverse flows. Reverse power flows are detrimental for UFLS operation because they offset the intended outcome of UFLS activation (by disconnecting circuits that are net generators, rather than net loads), and mean that more load customers must be disconnected to achieve the same arrest in a frequency decline.

Figure 10 shows the percentage of the year that various (anonymised) sub-transmission loops in Victoria were in reverse flow over the period 2018 to 2022, and Figure 11 shows the maximum reverse power flow from these sub-transmission loops.

Key findings are as follows:

- Five sub-transmission loops were identified to have large wind and solar generators located on UFLS circuits (such that they will be disconnected when UFLS relays operate). This is detrimental to UFLS functionality. These loops are in reverse flow up to 60% of the time, and experience reverse power flows as large as 115 MW.
- Sub-transmission loops were also identified with high levels of DPV. In 2022, these loops experienced reverse flows as high as 42 MW and were in reverse flows for up to 15% of the year.
- 26 sub-transmission loops on the UFLS scheme that were not in reverse flow in 2018 are now exhibiting reverse power flows, based on data from 2022.

⁸⁶ Estimated forecast based on historical feeder level data from SA Power Networks.

⁸⁷ See <https://aemo.com.au/-/media/files/initiatives/der/2021/vic-ufls-data-report-public-aug-21.pdf?la=en&hash=A72B6FA88C57C37998D232711BA4A2EE>.

⁸⁸ See https://aemo.com.au/-/media/files/stakeholder_consultation/consultations/nem-consultations/2022/psfrr/2023-05-25-vic-ufls-2022-review.pdf?la=en&hash=CFDBA2D60117E8E7FE452B2C2F468B3B.



Figure 10 Percentage of time in reverse flow for anonymised sub-transmission loops in the Victorian UFLS scheme

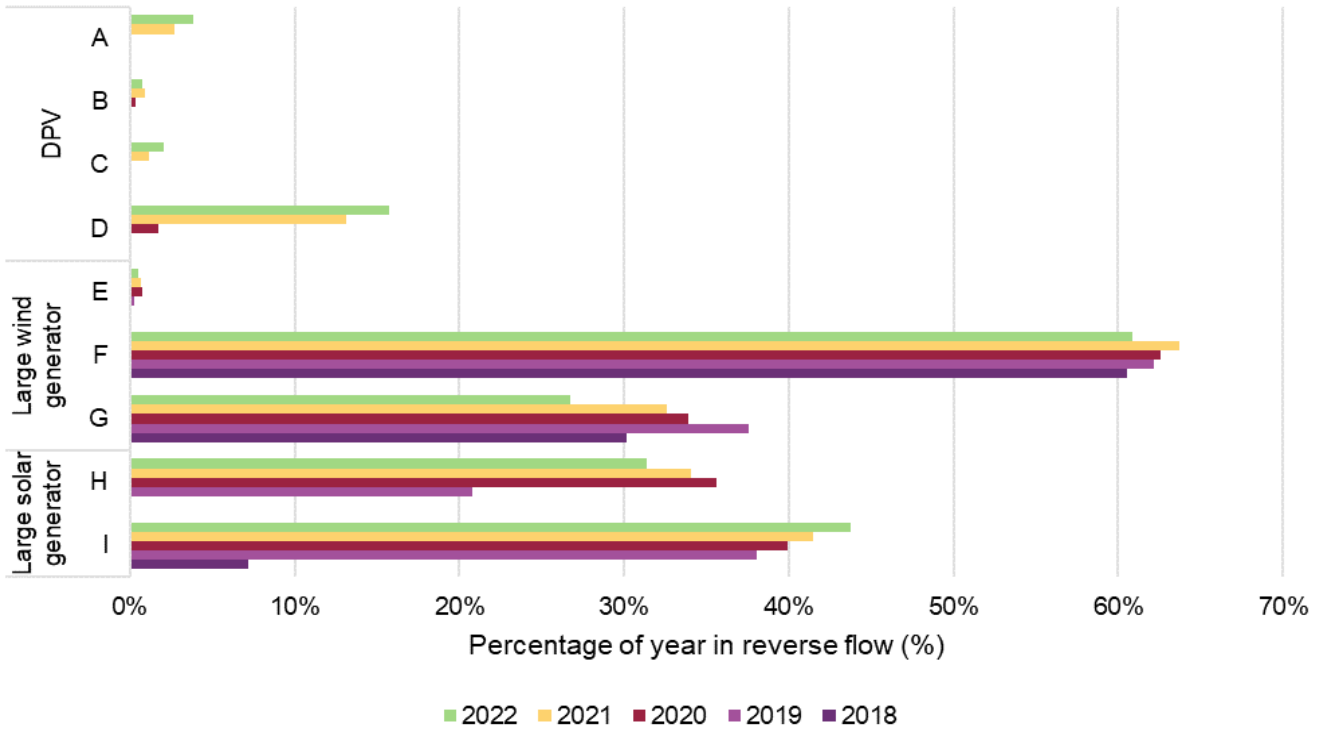
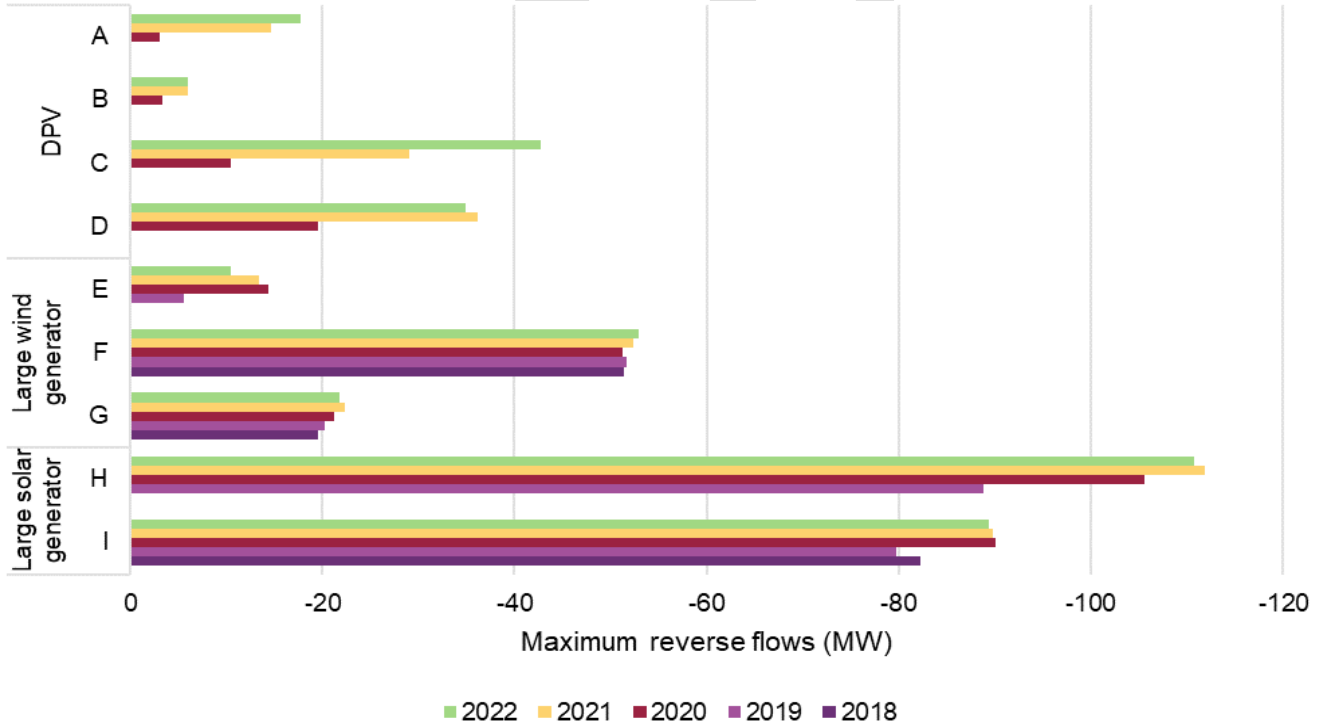

Figure 11 Maximum reverse power flows from anonymised sub-transmission loops in the Victorian UFLS scheme



AEMO has recommended that Victorian NSPs urgently investigate options to remediate UFLS, particularly addressing reverse flows. Dynamic arming of UFLS relays (automatically blocking of relay operation when the circuit is in reverse flows) should be explored.

Exploring feasibility of UFLS from advanced metering infrastructure (AMI)

AEMO has analysed the feasibility of different options for UFLS remediation, including UFLS at customer AMI. In October 2023, AEMO published a short report on the findings to inform further NSP investigation⁸⁹.

AEMO explored the feasibility of several possible remediation approaches for UFLS in Victoria:

- Option 1 – implement dynamic arming (automatic blocking of UFLS relay action when the circuit is in reverse flows) at the existing UFLS relay location (66 kV sub-transmission level), to prevent shedding of sub-transmission loops in reverse flows.
- Option 2 – move UFLS relays from 66 kV sub-transmission level to 22 kV feeder level, and implement dynamic arming, to provide more granularity and allow selective shedding only of 22 kV feeders that are net loads (while 22 kV circuits that are in reverse flows remain connected).
- Option 3 – implement UFLS functionality via AMI at the individual customer level, allowing selective shedding only of customer sites that are net loads (while individual customers that are net exporting remain connected). Note that this analysis only covered the technical feasibility of utilising AMI for load shedding, and regulatory changes would also be required to enable this, with further consideration to be given to the end-to-end impact of those changes.

These options were intended to provide high-level illustrative case studies, rather than an exhaustive consideration of all options. Each network location will have a variety of options that should be assessed individually by NSPs.

The analysis was conducted for four case studies of archetypal loops:

- A sub-transmission loop with a large solar farm.
- A loop with large wind farms.
- A loop with a high level of commercial load.
- A loop with mainly residential customers.

For each of these case studies, the different options to remediate UFLS load were investigated using actual load data from 2021 at the 66 kV sub-transmission level, the 22 kV feeder level, and aggregated from residential customer AMI.

Key findings were as follows:

- All options explored showed merit in different situations, and different options will likely be optimal in different locations.
- Using customer AMI appears to be a promising option which could restore a large proportion of UFLS load in the middle of the day for sub-transmission loops with a high proportion of residential customer load, and high levels of reverse flow due to DPV. A number of important feasibility issues remain to be explored, including:

⁸⁹ See <https://aemo.com.au/-/media/files/initiatives/der/2023/dynamic-arming-options-for-ufls.pdf?la=en&hash=F6B7A015C8EB872C83513BA9C95EFE5B>.

- The robustness of the AMI response in the fast response times required for UFLS (typically requiring detection and response to a severe under frequency event within 200-300 ms). This will require confirmation that mal-operation/false-triggering rates are suitably low, while ensuring a robust response in these rapid timeframes when required.
- The impacts on distribution feeder voltages from selectively shedding net-load customers while leaving net-exporting customers connected. In particular, it needs to be determined whether load tripping could result in a subsequent voltage rise that could lead to DPV tripping on instantaneous over voltage settings.
- The feasibility and costs of rolling out this capability across existing and/or new AMI, and how this implementation process might occur.
- This early feasibility study suggests that there is merit in NSPs exploring the AMI option further.

Emergency under frequency response requirement in high DER periods

As detailed in Section 5.3, in accordance with NER 5.20A.1, as part of the 2024 GPSRR, AEMO completed UFLS screening studies for mainland NEM regions to assess the current (FY 2022-23) and future (FY 2028-29) performance of the existing UFLS schemes and identify any need for remediation and/or modification.

In addition to the studies completed as part of this GPSRR, AEMO has undertaken analysis and modelling to evaluate risks associated with inadequate EUFR in low demand periods with high distributed generation in South Australia. EUFR could be delivered by traditional UFLS, or FFR from BESS or other IBR, or any other rapid frequency response that can arrest frequency decline in severe non-credible under frequency contingency events⁹⁰.

The aim of these South Australia EUFR studies was to understand plausible contingencies that could occur in South Australia in these low demand periods and determine how they can be adequately managed. The methodology consisted of:

- Developing a set of plausible non-credible contingency events that could occur in low demand periods.
- Modelling these contingency events across a wide variety of operating conditions with current and projected UFLS capability.
- Identifying failed cases and optimising the additional battery response required to achieve an acceptable result (avoiding cascading failure).
- Determining the EUFR required (UFLS + battery response) under varying operating conditions.

AEMO's assessment concluded that to maintain the present risk profile, based on historical levels of UFLS, would require a South Australia EUFR target (up until the commissioning of PEC Stage 2) that is the maximum of either:

- 700 MW, or
- 60% of operational demand.

⁹⁰ AEMO (May 2024), *Emergency Under Frequency Response for South Australia*, <https://aemo.com.au/-/media/files/initiatives/der/2024/2024-05-21-emergency-underfrequency-requirements-for-south-australia.pdf?la=en&hash=200839621941320C557B67B6DC4DF59A>.

Studies show this provides enough EUFR to manage the four multiple contingency events studied ~80% of the time. The rollout of dynamic arming of UFLS in South Australia, and the additional battery capacity in South Australia following commissioning of the Torrens Island BESS, mean that this target is expected to be met ~99.8% of the time. This delivers a similar level of residual risk to historical levels.

AEMO is continuing to review UFLS adequacy, particularly following commissioning of PEC Stage 2, which will fundamentally change the nature of the multiple contingency events being managed.

Because the South Australia EUFR requirement was assessed as part of this separate AEMO report, South Australia separation was not the focus of the 2024 GPSRR UFLS screening studies. As detailed in Section 5.3, for some of the South Australian import dispatch scenarios studied as part of the 2024 GPSRR, the available South Australian UFLS and large-scale BESS was not adequate to arrest frequency for South Australia following separation and the loss of two stations. This is consistent with findings in the South Australia EUFR studies, which showed that the proposed EUFR target managed the four multiple contingency events studied (including separation + loss of two stations) ~80% of the time.

6.3 Future UFLS projects

AEMO’s review of UFLS to date has identified a number of areas where further UFLS review or rectification should be explored. These are summarised in Table 29.

AEMO is also currently planning and resourcing a full UFLS review commencing in 2024. This review will involve a detailed evaluation of the regional UFLS bands and trip settings following the completion of the UFLS screening studies for the 2024 GPSRR, which assessed the performance/adequacy of the current UFLS schemes.

Table 29 Summary of future UFLS rectification areas

Area	Region	Notes
Rebalancing and optimisation of UFLS settings	SA	<ul style="list-style-type: none"> Re-distribute large amount of load assigned to the lowest UFLS bands (leads to non-optimal UFLS functioning and can result in overshoot following large contingencies). Review and optimisation of settings following dynamic arming upgrades.
	VIC	<ul style="list-style-type: none"> Review UFLS settings for large industrial loads (accounting for some known changes in those loads over time). Review coordination of UFLS with other regions (2020 studies suggest VIC UFLS over-delivers response compared with other regions, which can lead to power swings on interconnectors). Investigate possible over frequency over-shoot outcomes.
	NSW	<ul style="list-style-type: none"> Consolidate large number of UFLS settings bands for simpler coordination (review identified 121 different UFLS bands with different frequency/time delay settings)
	QLD	<ul style="list-style-type: none"> Review of the QLD UFLS QNI inhibit scheme (inhibits operation of some UFLS bands under certain power system conditions). Review of ongoing scheme appropriateness and optimal settings is required. Review of UFLS settings for large industrial loads, especially given addition of several new loads to the scheme. Review coordination of UFLS with other regions.
Real time SCADA feed of UFLS load in each band	SA	<ul style="list-style-type: none"> Real-time SCADA feed established for total SA UFLS load. Visibility increased with Dynamic Arming functionality is being rolled out. SA Power Networks is updating capability to provide visibility of load in individual UFLS bands (target completion: Q2 2025)

Area	Region	Notes
	VIC	<ul style="list-style-type: none"> Current capability allows AEMO to extract UFLS data post hoc. Real-time visibility should be explored to support improved real-time decision-making in low demand periods.
	NSW	<ul style="list-style-type: none"> Capability to measure reverse power flow on circuits required. Likely requires significant uplift of infrastructure (for example, metering improvements to identify reverse flows accurately). Real-time visibility should be explored to support improved real-time decision-making in low demand periods.
	QLD	<ul style="list-style-type: none"> NSPs currently working on a dashboard to provide real time visibility of UFLS. Likely requires uplift of infrastructure to facilitate (for example, metering improvements to identify reverse flows accurately).

6.3.1 2024 GPSRR recommendations

Additionally, as a result of the work completed for the 2024 GPSRR, AEMO makes the following recommendations.

UFLS data quality

As detailed in Appendix A4, currently there is no real-time visibility of Queensland, New South Wales and Victoria UFLS availability. In Victoria, locations of the UFLS relays align closely with the locations of TUoS metering in the Victorian network. As AEMO has direct access to this TUoS metering, it is possible for AEMO to extract and aggregate half-hourly load measurements to estimate the total amount of load in the UFLS at each frequency trip setting, in each half-hour on an ad-hoc basis. For Queensland and New South Wales, the existing data is from 2018 to 2020, and must be scaled based on current DPV installed capacity and regional operational demand. This poses an operational risk, as there is no guarantee that the estimated UFLS availability in Queensland and New South Wales is accurate.

Recommendation 6

AEMO therefore strongly recommends, as part of the next UFLS review, real-time visibility of UFLS availability be established for all NEM regions (similar to what exists for South Australia).

Updates to UFLS schedules and procedures

There is an urgent need to review and update the UFLS schedules used by the AEMO control room, as well as the associated procedures to ensure that they reflect the actual UFLS availability for each region. The current lack of accurate UFLS information available to the AEMO control room poses a significant operational/security risk, particularly for non-credible regional islanding events.

Recommendation 7

Therefore, AEMO strongly recommends that NSPs work with AEMO to provide up-to-date and accurate UFLS availability information as part of the next AEMO UFLS review.

Consolidation of New South Wales UFLS bands

As stated above, the real-time visibility of New South Wales UFLS availability is poor. Additionally, as detailed in Appendix A4, there are 121 UFLS bands in New South Wales with distinct trip settings. This complexity does not improve the effectiveness of UFLS in New South Wales and is therefore unnecessary.

Recommendation 8

AEMO recommends that AEMO, in consultation with Transgrid, review and consolidate the New South Wales UFLS bands to ensure that the scheme operates efficiently and effectively as part of AEMO's next UFLS review.

6.4 Emergency reserves and services

6.4.1 Reliability risks

With up to 62% of its coal fleet now expected to close before 2031⁹¹, Australia's NEM is perched on the edge of one of the largest transformations since the market was formed over 20 years ago, posing potential reliability challenges for the NEM.

When considering only energy supply infrastructure developments that meet AEMO's commitment criteria⁹², AEMO's 2023 Electricity Statement of Opportunities (ESOO) forecast larger reliability gaps than were forecast in the February 2023 *Update to 2022 Electricity Statement of Opportunities*, and in some cases, larger than forecast in the 2022 ESOO.

Over the next 10 years, in the 2023 ESOO Central scenario, reliability risks are forecast to be higher than the relevant reliability standard requires in:

- South Australia in summer 2023-24 (against the Interim Reliability Measure (IRM)⁹³ of 0.0006% unserved energy (USE)) and from 2028-29 (against the reliability standard of 0.002% USE⁹⁴).
- Victoria in summer 2023-24 and over the entire ESOO horizon against the IRM, and from 2026-27 against the reliability standard.
 - The 2023 ESOO determined that in summer 2023-24 expected unserved energy was forecast to exceed the interim reliability measure in the regions of South Australia and Victoria. As a result, in accordance with clauses 3.20 and 11.128 of the NER, to address the interim reliability exceedances in each of these regions

⁹¹ Including generators that have advised expected closure dates at or before 2033, and generators identified in the Queensland Energy and Jobs Plan as being subject to possible closure at or before 2033.

⁹² The ESOO Central scenario includes committed, in commissioning, and anticipated generation, storage and transmission projects, according to AEMO's commitment criteria, as well as committed investments in demand flexibility and consumer batteries that are orchestrated to minimise grid requirements.

⁹³ The IRM is a measure of expected USE in any region of no more than 0.0006% of energy demanded in any financial year. On 25 May 2023, the AEMC released a final report recommending that the application of IRM to the retailer reliability obligation (RRO) be extended to 30 June 2028 (see <https://www.aemc.gov.au/market-reviews-advice/review-interim-reliability-measure>).

⁹⁴ USE represents energy that cannot be supplied to consumers when demand exceeds supply under certain circumstances, resulting in involuntary load shedding (loss of customer supply) in the absence of out of market intervention, such as the Reliability and Emergency Reserve Trader (RERT) and interim reliability reserves or other voluntary curtailment.

in 2023-24, AEMO sought to procure interim reliability reserves (IRR)⁹⁵. AEMO entered into reserve contracts with three providers for the provision of IRR from 1 December 2023.

- New South Wales from 2025-26 against the reliability standard.
- Queensland in 2029-30 and 2030-31 against the reliability standard.

Hence, the 2023 ESOO forecasted reliability gaps in all mainland NEM regions in the next decade when considering only those energy supply infrastructure developments that have made sufficient progress against AEMO's commitment criteria⁹⁶, signalling a need for further commitment and delivery of generation, transmission, demand side participation (DSP) and consumer assets such as batteries that can be orchestrated to minimise grid requirements.

New information became available since AEMO released the 2023 ESOO in August 2023 that warranted reassessment of the supply and demand outlook in the NEM through the Update to the 2023 ESOO, which was published in May 2024⁹⁷. This new information included new commissioning dates for PEC, mothballed gas generators in South Australia, and approximately 4.6 GW of new generation and storage projects.

While these changes to various existing and new developments across the power system change the reliability outlook in some market regions, this Update to the 2023 ESOO reinforces that urgent investments in capacity in the NEM are needed to manage reliability risks. Continued investment in transmission, generation, storage and CER, supported by existing federal and state policies, is forecast to lower reliability risks, yet additional opportunities remain for market investments to reduce reliability risks to below the relevant reliability standard over the next 10 years.

Reliability gaps continue to be forecast over the 10-year outlook in all mainland NEM regions when considering only those developments that meet AEMO's commitment criteria. Reliability risks in the ESOO Central scenario, relative to the 2023 ESOO, have:

- Increased in New South Wales between 2024-25 and 2027-28 due to advised delays to previously considered battery projects and revised assumptions for demand allocation within New South Wales.
- Increased in Victoria until 2027-28 due to mothballed generators in South Australia and transmission limitations affecting flows into Melbourne.
- Increased in South Australia in 2026-27 due to the advised delay of PEC Stage 2 to after the previously advised closure timings of the Torrens Island B and Osborne Power Stations, resulting in a newly identified reliability gap.
- Decreased in Victoria and South Australia from 2028-29 when Yallourn Power Station retires, due to a newly advised transmission configuration planned for the Latrobe Valley transmission network.

⁹⁵ See <https://aemo.com.au/en/energy-systems/electricity/emergency-management/reliability-and-emergency-reserve-trader-rert/rert-tendering>.

⁹⁶ Commitment criteria relate to land, contracts, planning, finance, and construction, and are explained in each update on AEMO's Generation Information web page at <https://www.aemo.com.au/Electricity/National-Electricity-Market-NEM/Planning-and-forecasting/Generationinformation> and Transmission Augmentation information web page at <https://www.aemo.com.au/energy-systems/electricity/nationalelectricity-market-nem/nem-forecasting-and-planning/forecasting-and-planning-data/transmission-augmentation-information>

⁹⁷ See https://aemo.com.au/-/media/files/electricity/nem/planning_and_forecasting/nem_esoo/2023/may-2024-update-to-the-2023-electricity-statement-of-opportunities.pdf?la=en.

As a result of the reliability gaps forecast in the ESOO Central scenario, AEMO will tender for IRR which support New South Wales and Victoria to minimise the consumer impact of reliability risks should low reserve conditions emerge over summer 2024-25.

However, federal and state government programs, actionable transmission developments, orchestrated consumer investments and demand flexibility have the potential to address the majority of forecast reliability risks. These additional investments in renewable generation, dispatchable capacity, transmission and CER are forecast to reduce reliability risks to below the relevant reliability standard in most regions in most years of the 10-year horizon if they progress as advised. Additional investments are required to further reduce reliability risks. Existing policies, such as future tenders for the capacity investment scheme, and various renewable energy and storage targets of state governments, will contribute to supporting these investments and will be assessed as more information on the actual projects become available.

To address reliability risks new supply developments will be needed and will also need to connect in locations that can service loads, which at times may be geographically distant. Without further transmission development, the ESOO analysis showed that there are limited locations that will benefit power system reliability, and that technologies that have greatest capacity to operate continuously through a potential reliability event (such as deeper storage technologies and other dispatchable technologies) will provide greatest reliability benefit.

The 2023 ESOO and Update to the 2023 ESOO contained the following key findings in relation to the changes in reliability conditions in the NEM detailed above:

- Higher maximum demand conditions, and lower minimum demand conditions are forecast.
- Demand outcomes more likely at upper range of maximum demand forecast during El Niño weather conditions.
- Underlying consumption continues to increase, with DER and energy efficiency measures slowing the operational demand growth.
- Consumer investments and load flexibility have the potential to minimise reliability risks.
- Significant growth potential is forecast for consumers to engage with virtual power plants (VPPs).
- The availability of wind generation at time of maximum demand is a major factor influencing the risk of USE.
- Actionable transmission developments significantly improve the reliability outlook.
- Federal and state generation development schemes have the potential to address the majority of longer-term risks.
- Delaying generator retirement has the potential to address medium-term risks if necessary.
- The opportunity to improve power system reliability in the NEM varies by technology and location.

Summer readiness

Expected USE⁹⁴ in this ESOO is an annual average representation of the risk of load shedding, using a range of statistically variable inputs. However, the actual occurrence of load shedding in a given year can be lower than or higher than the relevant reliability standard, and can be considerably higher than the standard if particular combinations of weather events and outages occur.

Operationally, AEMO needs to be prepared to manage the power system if specific events arise, such as:

- Severe weather or power system events that result in prolonged transmission network unavailability.
- Periods of generation unavailability, including planned and unplanned outages.
- Delays to the commissioning of new transmission, generation or storage capacity.
- Operational impacts of extreme temperature on all generation technologies that may reduce output to below the rated generator capacity.
- Periods of low minimum demand that risk the security of the power system.

Some of these risks are further considered in AEMO's summer readiness program each year:

- AEMO collaborates with industry to identify the preparedness of the system for summer, and operational options to mitigate these risks. AEMO works closely with generators and TNSPs to ensure outages are co-ordinated and essential work is completed as required.
- AEMO can mitigate some of the supply adequacy risks with the use of supply scarcity mechanisms such as IRR and Reliability and Emergency Reserve Trader (RERT)⁹⁸, where appropriate.

6.4.2 Major project delays and impact on reserves and system security

Project development delays and broader supply chain challenges are emerging as material risks to the delivery of transmission, generation and storage projects. Delays to the delivery of any of the identified projects, relative to the dates envisioned by the schemes and proponents, have the potential to result in periods of high reliability risk throughout the 10-year horizon.

As outlined in the 2024 Draft ISP⁹⁹, the need for planned investment remains urgent. The sooner firmed renewables are connected, the more secure the transition will be. However, the risk of replacement generation not being available when coal plants retire is real and growing, and is a risk that must be avoided. Unplanned generator outages are increasing, as coal plant reliability is affected by reduced investment and high-impact weather events. Planned projects are not progressing as expected, due to approval processes, investment decision uncertainty, cost pressures, social licence issues, supply chain issues, workforce shortages and other issues. Therefore, major project proponents should endeavour to meet published timelines and update industry as early as possible regarding delays such that mitigative actions can be taken to manage any system reliability or security deficits.

The expansion of the federal Capacity Investment Scheme on 23 November 2023 recognises this urgency, giving additional support for the development of 32 GW of new capacity nationally, including 23 GW of renewable energy and 9 GW of clean dispatchable capacity¹⁰⁰.

⁹⁸ See <https://aemo.com.au/en/energy-systems/electricity/emergency-management/reliability-and-emergency-reserve-trader-rert/rert-tendering>.

⁹⁹ See https://aemo.com.au/-/media/files/stakeholder_consultation/consultations/nem-consultations/2023/draft-2024-isp-consultation/draft-2024-isp.pdf?la=en.

¹⁰⁰ Australian Government. 'Capacity investment scheme', November 2023, <https://www.energy.gov.au/government-priorities/energy-supply/capacity-investment-scheme>.

Risks in securing critical energy assets and workforce

The deep investments required in the ISP imply the need for thousands of critical energy assets – grid-scale generators and batteries, high voltage transmission lines and cables, synchronous condensers and transformers – and the people needed to install and operate them.

In a global energy transformation, countries are competing for the same materials, technologies and expertise. The stimulus to renewable energy innovation and investment prompted by the *US Inflation Reduction Act (IRA)* has placed a global premium on these assets. Australia may benefit from outcomes of this investment, such as accelerated technology development, although it will increase competition for investment and skills.

This competition may exacerbate three existing risks:

- First, Australia may not be able to access reliable and cost-effective supply of these assets over the next 15 years, as global demand for them rises, and the global supply chain remains vulnerable. Some actionable ISP projects have already experienced schedule delays, and such slippages are likely to continue.
- The race to net zero may also push up some costs. Transmission cost estimates have increased approximately 30% in real terms over the past two years and future cost reductions are very unlikely¹⁰¹. Costs for wind and solar have increased over the past year, largely due to pandemic-related supply chain issues, however, wind and solar costs are forecast to continue their long-term decline with still further innovation.
- A further risk is that investment is not made in the training and immigration initiatives needed to secure a workforce for the energy transition. A large skilled workforce in Australia, across every discipline not just engineering, is needed for the enormous task ahead. The demand for skilled people directly employed to build new energy infrastructure is forecast to increase from approximately 48,000 in 2025 to over 70,000 across the horizon to 2050¹⁰², in the *Step Change* scenario. This growth will challenge engineering, procurement and construction (EPC) firms and regional communities, particularly if there are boom-and-bust cycles or if workers and contractors are engaged project-to-project.

Repurposing existing generators as synchronous condensers

The addition of synchronous condenser capability in the mainland NEM is considered to be essential in enabling the energy transition and operation at higher levels of instantaneous IBR generation. However, the international energy transition and adoption of more inverter-based renewable generation is driving international demand for new large synchronous condensers. The delivery times for large synchronous condensers (>100 MVA) are growing, making it more challenging to procure and install enough synchronous condensers in a timely manner to consistently provide the services needed by AEMO within the next five to 10 years.

Hence, the repurposing of existing generators as synchronous condensers will be required to achieve optimal deployment of synchronous condenser capability in the mainland NEM within the required timeframe. AEMO has worked closely with Australian Renewable Energy Agency (ARENA) to support a feasibility study report of

¹⁰¹ AEMO. 2023 *Transmission Expansion Options Report*, p 4, <https://www.aemo.com.au/energy-systems/major%20publications/integrated-system-plan-isp/2024-integrated-system-plan-isp/current-inputs-assumptions-and-scenarios>.

¹⁰² This forecast is an estimate based on the Draft 2024 ISP results, using the workforce projections method provided by the Institute for Sustainable Futures for the 2022 ISP. AEMO will update this forecast for the final 2024 ISP to ensure alignment with the Institute's method and if required to reflect any relevant updates from the Infrastructure Australia Market Capacity for Electricity Infrastructure update due for release in December 2023.

synchronous condenser conversion opportunities in Australia, in particular fossil-fuelled options. The report is complete¹⁰³ and ARENA is now considering next steps.

In summary, the key findings from the report are:

- At face value, the conversion of existing fossil-fuelled synchronous generators to synchronous condensers should provide a cost-effective way of delivering the required security services to the power system through an existing point of connection, which already has most of the required infrastructure to support the operation of the plant as a synchronous condenser.
 - The size of the larger generator units (upwards of 750 MVA) is several times that of a synchronous condenser (around 125 MVA), meaning one conversion could substitute for up to five or more new synchronous condensers.
 - Hydro generators can be, and are, also used for this purpose, with many already able to operate as synchronous condensers. Comparatively, the opportunity for fossil-fuelled generator repurposing is very much greater than that available from hydro.
- Operation of a re-purposed generator as a synchronous condenser will:
 - Help stabilise the system voltage and thus provide system strength.
 - Depending on how the conversion is implemented, contribute inertia at a significant, but possibly reduced, level when compared with the original generator.
 - Provide a source of reactive power for voltage control.
 - Contribute positively to fault levels.
- The report analysis indicates that repurposing generators as synchronous condensers can provide a viable solution for delivering the required security services (such as system strength and reactive support). This approach can be used in combination with new synchronous condenser investments to mitigate the risk of insufficient services.
- Repurposing of existing generators has benefits including:
 - Faster implementation times than procuring new synchronous condensers in a tightening international market – repurposing could potentially be achieved in 12-24 months at some sites with new investments taking 30+ months.
 - Larger scale, given that the existing generators typically have higher ratings than new synchronous condensers.
 - In most cases, delivery at lower costs than new synchronous condensers.
- The report concluded that repurposing appears feasible at some sites and more work is required to determine specific conversion options and costs, given that there is a significant variability in plant condition and power station arrangements.

¹⁰³ See <https://arena.gov.au/assets/2023/06/repurposing-existing-generators-as-synchronous-condensers-report.pdf>.

6.4.3 Emergency contingency plans for reserves and security services

In addition to those specified in Section 6.4.1, AEMO has identified the following NEM reliability risks for the coming summer and future years:

- Potential for higher peak demands, for example due to unexpected severe weather.
- Increased forced generator outages (including fuel availability issues or equipment breakdown).
- Increased unplanned outages of transmission elements.
- Decreases in inter-regional peak transfer capacity (including abnormal system conditions).
- Delays to the commissioning of new generation, transmission, or storage capacity.
- Operational impacts of extreme temperature on all generation technologies that may reduce output to below the rated generator capacity.

In recent years, some jurisdictions have procured emergency reserves to help address these emerging risks or issues. It takes significant planning, time, and resources for a jurisdiction to procure emergency reserves. However, emergency reserves can be designed with unique requirements and bespoke conditions which may not be possible under the RERT framework (see Section 6.4.1). These emergency reserve projects have been initiated at short notice (under 12 months), requiring expedited review.

To help address this risk, as part of the 2023 GPSRR¹⁰⁴, AEMO recommended that all jurisdictions develop contingency plans that identify and scope potential locations to install emergency generation. Additionally, AEMO recommended that jurisdictions also consider planning to ensure the availability of system security services for unexpected conditions and develop contingency plans that detail the possible procurement of additional system strength and voltage control services. For example, prolonged forced outages of existing coal and gas plants may result in a deficit of available services for N-1 security and power system resilience. The potential lead times to replace services with other equipment such as synchronous condensers and grid forming inverters could be significant. A contingency plan to address this risk could include the conversion of existing facilities to synchronous condenser operation, as detailed in Section 6.4.2.

2023 GPSRR Recommendation 4

As part of the 2023 GPSRR, AEMO recommended that each participating jurisdiction develop and coordinate emergency reserve and system security contingency plans, which can be implemented at short notice if required to address potential risks. These plans should be for an appropriate level of capacity for the region, and encompass details of the generation technology, connection point and connection arrangement, fuel supply adequacy, environmental considerations, construction, and commissioning timelines as well as equipment availability and lead times. Given the widespread thermal generator retirements, AEMO notes that this is a growing priority for jurisdictions to action.

¹⁰⁴ See https://aemo.com.au/-/media/files/stakeholder_consultation/consultations/nem-consultations/2023/draft-2023-general-power-system-risk-review/2023-gpsrr.pdf?la=en.

6.4.4 Emergency management of system strength

System strength can broadly be described as the ability of the power system to maintain and control the voltage waveform at any given location in the power system, both during steady state operation and following a disturbance¹⁰⁵. As summarised above, the 2023 GPSRR foreshadowed risk of unexpected low system strength conditions and the need for emergency contingency plans.

Regional system strength requirements

In the planning timeframe, the System Strength Framework and associated methodology and guidelines detail how the NEM system strength requirements are determined by AEMO and how jurisdictional planning bodies for transmission will be responsible for proactive provision of system strength services, as System Strength Service Providers (SSSP)¹⁰⁶.

Following the *National Electricity Amendment (Efficient management of system strength on the power system) Rule 2021*¹⁰⁷, SSSPs must deliver adequate levels of system strength for the NEM from 1 December 2025. Before this date, AEMO is able to declare system strength shortfalls against the standard. SSSPs must address any system strength shortfalls declared by AEMO for this interim period.

AEMO must publish the system strength requirements annually by 1 December. These requirements are, under NER 5.20C.1(c), for each system strength node¹⁰⁸:

- The minimum three-phase fault level for the upcoming year commencing 2 December, to be used for the purposes of maintaining power system security.
- AEMO's forecast, for each of the next 10 years, of:
 - the minimum three-phase fault level; and
 - the projected level and type of IBR and market network service facilities, to be used by SSSPs for the purposes of meeting the system strength standard specification under NER S5.1.14.

The minimum fault level requirements at regional nodes¹⁰⁹ take into account:

- **Voltage control system operational needs** – the minimum three-phase fault level must be set so as to enable stable operation of voltage control systems, such as capacitor banks, reactors and dynamic voltage control equipment.
- **Protection system operational needs** – the minimum three-phase fault level must be sufficient to enable protection systems of transmission networks, distribution networks, Transmission Network Users and

¹⁰⁵ For more information on system strength, see AEMO, *Power System Requirements*, July 2020, at https://www.aemo.com.au/-/media/Files/%20Electricity/NEM/Security_and_Reliability/Power-system-requirements.pdf and AEMO, *System strength explained*, March 2020, at <https://aemo.com.au/-/media/files/electricity/nem/system-strength-explained.pdf>.

¹⁰⁶ See <https://aemo.com.au/en/consultations/current-and-closed-consultations/ssrmiag>.

¹⁰⁷ See <https://www.aemc.gov.au/rule-changes/efficient-management-system-strength-power-system>.

¹⁰⁸ See https://aemo.com.au/-/media/files/electricity/nem/security_and_reliability/system-strength-requirements/system-strength-requirements-methodology.pdf?la=en.

¹⁰⁹ An SSN is a physical location on the transmission network of an SSSP, at which AEMO must determine system strength requirements and apply those requirements for power system security purposes under Chapter 4 of the NER.

Distribution Network Users to operate correctly (NER S5.1a.9(a)). Correct operation of those protection systems must be consistent with all applicable requirements of NER S5.1.9.

- **The ability to maintain network power system stability** – AEMO interprets the phrase ‘power system to remain stable’ in NER S5.1a.9(a)(3) to mean ‘stable conditions’ consistent with the definition of a satisfactory operating state under NER 4.2.2(f)).

Currently, in the operational context, the minimum fault level requirements across the regional system strength nodes translate to minimum regional synchronous generating unit combinations. As such, there is an increasing risk of unforeseen system strength shortfalls because of early generation retirements, fuel shortage conditions, or forced outages of system strength contributing generating units. This reinforces the importance of jurisdictions developing emergency contingency plans for the procurement of system strength and voltage control services that can be actioned in the event of an unforeseen shortfall.

In determining the regional system strength requirements, AEMO considers high impact credible contingencies (and any existing protected events). Additionally, following the *National Electricity Amendment (Efficient management of system strength on the power system) Rule 2021*, there is also a requirement for AEMO to consider the impact of critical planned network outages. As such, the minimum system strength requirements do not account for the risk of non-credible or multiple contingency events, and the risk of cascading failures resulting in the loss of multiple synchronous generating units. As the system transitions to operating down to the minimum system strength requirements, the risk of cascading failure due to non-credible contingency events involving the loss of synchronous units will increase significantly. For example, the Loy Yang CBF event studied as a priority risk in the 2024 GPSRR (refer to Section 1.2) could result in only 1-2 synchronous generating units remaining online in Victoria if that contingency occurs when Victoria is operating at the minimum system strength requirements. Additionally, the availability of fast-start units will determine if and how quickly the system can be resecured following such a contingency event.

As discussed in Section 5.1, as part of the next GPSRR, AEMO will assess the worst (N-2) and CB fail events across all NEM regions for impact on system strength and the possible cascading failures for use in operations and system resilience planning. AEMO will then engage with NSPs on options to improve network resilience.

Operational management of system strength

In the operational pre-dispatch (PD) projected assessment of system adequacy (PASA) timeframe, the AEMO control room manages system strength through constraints and directions in line with the Power System Security Guidelines¹¹⁰ (SO_OP_3715), as well as the relevant regional system security procedures, contingency plans and limit advice. Operational and limit advice is required to make adjustments to the minimum requirements/combinations considering the actual operating conditions, such as the availability of fast start units to be able to re-secure following a credible contingency, and prior network outage conditions.

For example, on 6 March 2023, the synchronous fault level at the Burnie 110 kV busbar dropped below the 850 MVA secure limit for approximately 124 minutes during a planned outage of Palmerston – Sheffield 220 kV

¹¹⁰ At https://www.aemo.com.au/-/media/Files/Electricity/NEM/Security_and_Reliability/Power_System_Ops/Procedures/SO_OP_3715%20Power-System-Security-Guidelines.pdf.

transmission line¹¹¹. From discussions between TasNetworks and AEMO, it was determined that the system was not operated in a secure state due to an incorrect minimum fault level limit being specified in the TasNetworks outage assessment technical advice. This advice related to the planned outage of the Palmerston – Sheffield 220 kV line that occurred on 6 March 2023.

Therefore, AEMO recommends that NSPs continue to supply AEMO with timely and accurate limit advice regarding system strength requirements, including minimum system protection operational requirements, for planned and forced outages and contingency plans.

As the number of synchronous generating units in the system reduces, there will be a greater risk of low system strength conditions due to forced outages and an increased need for directions for system security. It will therefore be important for AEMO to communicate the regional system strength requirements to the market, including the system strength coefficients of synchronous generating units at key system strength nodes, to provide transparency and help elicit a market response to any shortfalls. Additionally, system strength tools for all regions will be required to manage and monitor the system strength contributions from synchronous units, and identify the optimum regional minimum system strength combinations. Operational procedures should also be developed for scenarios where insufficient synchronous units are available for AEMO to direct to meet the minimum regional system strength requirements, including the appropriate limit advice and contingency plans from NSPs.

The ability of AEMO to operate the system down to the minimum system strength requirements while maintaining power system security will require sufficient wide-area visibility of power system performance and voltages, and effective control room tools for leveraging this data for stability monitoring to support real-time decision-making. This will be essential for identifying system security violations and responding to power system contingency events or abnormal conditions, and was covered by Engineering Framework FY23 Action A43: Promote widespread phasor measurement unit (PMU) roll-out and high-speed data ingestion/automation¹¹².

The ongoing TNSP rollout of PMUs and AEMO implementation of a Wide Area Monitoring System (WAMS) will enable time-synchronised monitoring of dynamic behaviour across the power system. AEMO has been collaborating with NEM TNSPs to establish priority locations for PMUs, with coverage over 140 high voltage substations (corresponding to about 1,000 3-phase channels) expected by December 2025. Figure 12 below shows the planned PMU installations across NEM regions. AEMO will also leverage the increased system monitoring capabilities (through PMU and WAMS) for ongoing power system model validation.

¹¹¹ See https://aemo.com.au/-/media/files/electricity/nem/market_notices_and_events/power_system_incident_reports/2023/burnie-110-kv-bus-low-fault-level.pdf?la=en.

¹¹² See <https://aemo.com.au/-/media/files/initiatives/engineering-framework/2023/nem-engineering-roadmap-fy2024--priority-actions.pdf?la=en#:~:text=This%20Engineering%20Roadmap%20FY2024%20priority,instantaneous%20renewables%20in%20the%20NEM.>

Figure 12 Future PMU installations in the NEM

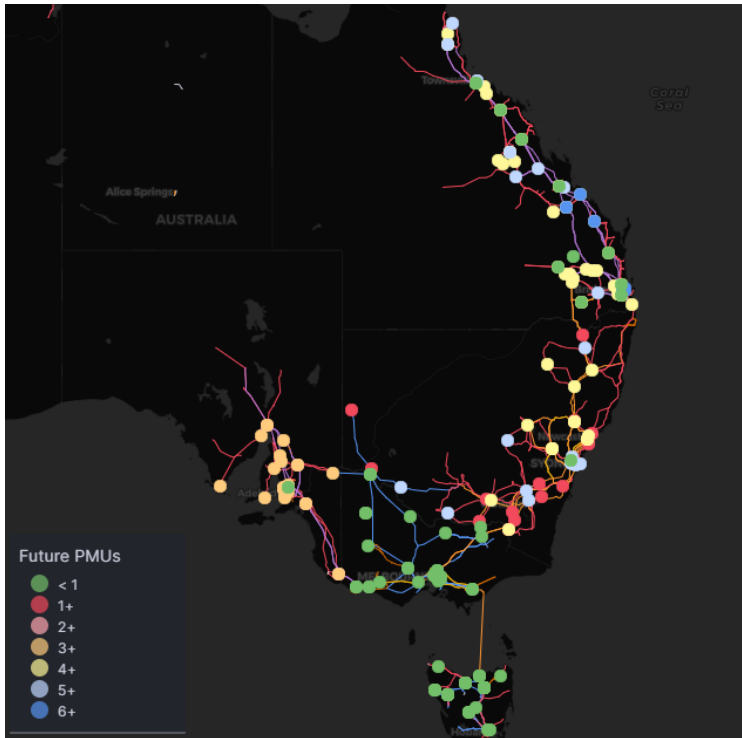

Additionally, for managing contingency events or forced outages impacting regional system strength, AEMO does not currently have a real-time electromagnetic transient (EMT) analysis tool to analyse system voltage stability and system strength. The lack of real-time EMT tools increases the risk that AEMO cannot re-secure the power system within 30 minutes following a contingency event impacting system strength, due to the time it takes to complete EMT studies and identify appropriate actions to resecure.

This risk was almost realised on 12 March 2021 when, due to a fire impacting equipment at Torrens B West, the simultaneous loss of all TIPS B generators was reclassified as a credible contingency from 1750 hrs to 2340 hrs¹¹³. During this time, if all TIPS B generators had tripped (a credible contingency) there would have been no secure system strength combinations available for dispatch in South Australia. To rectify this situation, AEMO had to undertake urgent offline analysis using EMT simulation software to identify additional system strength generator combinations, which took several hours. These generator combinations allowed greater flexibility, giving AEMO combinations of generation in South Australia which did not require TIPS B units to be online. Fortunately, the TIPS B2, B3 and B4 remained in service and post-incident analysis has confirmed that throughout this incident the combination of synchronous generators online at any one time was sufficient to maintain South Australia system strength. However, if the EMT analysis had found that the system would not land satisfactory following this credible contingency with the existing combination of synchronous generators online, the system would have been insecure for the several hours it took to complete the analysis.

¹¹³ See https://aemo.com.au/-/media/files/electricity/nem/market_notices_and_events/power_system_incident_reports/2021/final-report-torrens-island-275-kv-west-busbar-trip.pdf?la=en.

To address this risk, as part of the Operations Simulator project, AEMO is currently working with vendors to improve the speed and capabilities of EMT simulation tools (refer to Section 6.8)¹¹⁴. The Operations Simulator will ultimately be a fast online EMT contingency analysis tool to aid control room decision-making.

Insufficient synchronous units BowTie

In accordance with AEMO's risk management methodology, as described Section 1.5.2, AEMO has a BowTie for operating conditions with insufficient synchronous units, which outlines controls to mitigate this risk. This BowTie addresses the potential for risks associated with there being inadequate system strength services to direct and includes NSP contingency plans as a control.

Recommendation 4

AEMO anticipates significant operational challenges to emerge as thermal generating units retire and will develop operational procedures for scenarios where insufficient synchronous units are available for AEMO to direct to meet the minimum regional system strength requirements. This will include a BowTie risk assessment that incorporates the appropriate limit advice and contingency plans from NSPs.

New South Wales system strength requirements

On 15 November 2023, AEMO issued directions to maintain the minimum number of required synchronous generators in New South Wales – first for security (system strength direction) then second for reliability. For New South Wales, the secure system strength requirements are defined as having a minimum of seven large synchronous generators (N-1 secure system operation)¹¹⁵.

Transgrid has since provided AEMO with updated limit advice relating to the New South Wales system strength requirements. Based on this advice, the limiting factor for New South Wales is protection coefficients, and therefore this can be used to determine the contribution of synchronous generators to the three-phase fault level requirement. As the limiting issue for New South Wales is fault level (per advice from Transgrid), AEMO recommends that Transgrid monitor fault levels to identify potential issues in the operational timeframe, with consideration of network configuration and contributions from adjacent regions.

While it is appropriate to have some engineering margin on limits, the current requirement of seven large units needs to be reviewed to identify if the limit could be reduced. However, reducing the requirements will require appropriate analysis to ensure that it does not result in unintended consequences like generators failing to ride through certain faults. Transgrid is currently reviewing the system strength limit advice provided to AEMO to further refine the requirements for a “satisfactory” and “secure” operating condition. Transgrid provided additional interim advice to AEMO on the contribution of small synchronous generating units to the stable operation and protection of the New South Wales transmission network in February 2024¹¹⁶. The results of the initial studies

¹¹⁴ See <https://aemo.com.au/en/initiatives/trials-and-initiatives/real-time-simulator>.

¹¹⁵ See p 90, https://aemo.com.au/-/media/files/electricity/nem/planning_and_forecasting/operability/2022/2022-system-strength-report.pdf?la=en.

¹¹⁶ New South Wales Synchronous Generation. Interim Advice for System Normal Requirement 14/02/2024, https://aemo.com.au/-/media/files/electricity/nem/security_and_reliability/congestion-information/2024/transfer-limit-advice---system-strength-nsw.pdf?la=en.

provide a value representing a fractional contribution of the smaller units, and Transgrid is now conducting further extensive studies, which will result in a different method of consideration.

Although the 2023 GPSRR foreshadowed the risk of not having adequate system strength, the 2023 System Strength Report¹¹⁷ indicated operation of New South Wales above the minimum requirements for greater than 99% of the time for FY 2024 and FY 2025 (refer to Figure 13). However, this is only a forecast, and therefore there is a risk that operational conditions could deviate from this forecast.

In early-mid November 2023, due to a combination of generator planned and forced outages, AEMO forecast potential for operation below minimum synchronous generator requirements in New South Wales. Mount Piper 2 delayed its outage, which would have otherwise likely resulted in a system strength shortfall. Later, a planned outage of Bayswater Unit 2 would have similarly led to a shortfall.

Therefore, as the number of synchronous generating units in the NEM reduces, more security directions may be required to ensure the minimum system strength requirements are maintained across all NEM regions. Additionally, it will become increasingly difficult to operationally manage long-term or unplanned outages of synchronous plants. As discussed above, there may be situations where there are insufficient synchronous generating units to direct.

Figure 13 Synchronous units projected online under Step Change scenario, New South Wales, AEMO 2023 System Strength Report

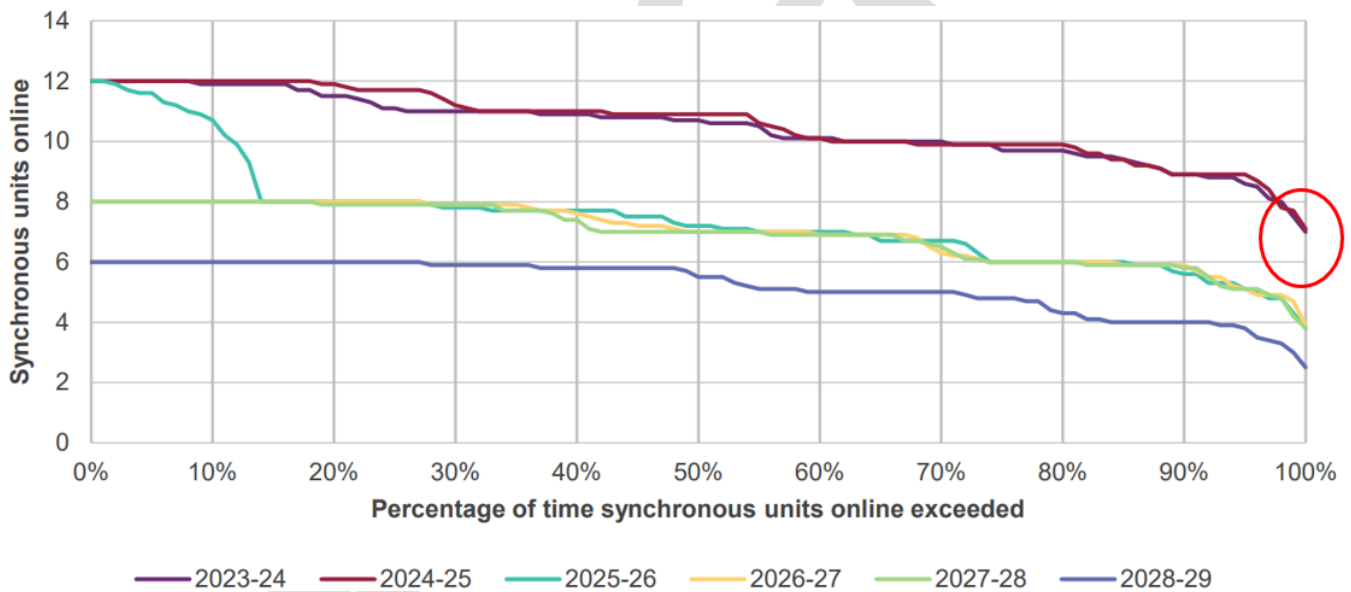

Management of New South Wales system strength post Eraring retirement

There is an existing recommendation from the 2023 GPSRR regarding Transgrid’s investigation of the risk and consequence of non-credible contingencies on the 330 kV lines supplying Sydney, Newcastle and Wollongong following potential Eraring Power Station closure.

¹¹⁷ See https://aemo.com.au/-/media/files/electricity/nem/security_and_reliability/system-strength-requirements/2023-system-strength-report.pdf?la=en.

In the context of the operational issues relating to the management of system strength and power system security in New South Wales detailed above, it is important that this investigation also considers power system security and the procurement of system strength, including any system protection modification/changes that are required to enable operation of the power system at lower fault levels.

6.5 Fuel supply interruptions/supply scarcity issues

In addition to the need for new generation, transmission and other solutions, the ongoing availability of coal, gas and distillate fuels, and effective management of their supply chains, will be critical to the reliability of the NEM. Risks to energy availability, such as drought conditions and/or coal, gas or diesel fuel shortfalls, have the potential to reduce reliability in the NEM. The impact of potential coal, gas and diesel fuel shortfalls was identified as a material risk to the reliability of the NEM in the 2023 ES00¹¹⁸.

The Energy Adequacy Assessment Projection (EAAP) forecasts electricity supply reliability in the NEM over a 24-month outlook period. The EAAP complements the ES00 reliability assessments, providing a focus on the impact of energy constraints on reliability. Potential energy constraints include water availability for hydro generation and as cooling water for thermal generation during drought conditions, and constraints on fossil fuel supply.

The EAAP included in the 2023 ES00 explored these risks over a 24-month horizon. Under most likely conditions, the EAAP identified reliability risks above the IRM¹¹⁹ in New South Wales, in addition to South Australia and Victoria which were above the IRM in both the EAAP and the ES00. The additional risks identified in the EAAP Central scenario in New South Wales were due to low fuel availability expectations from some gas generators. The EAAP also identified significantly increased risks if thermal fuels are scarcer, highlighting the importance of maintaining the availability of coal, gas and distillate fuels, and the effective management of their supply chains.

Therefore, interruption to fuel supply chains has the potential to cause major supply scarcity issues. Below are some examples of events that could lead to supply scarcity issues:

- Thermal power stations:
 - Loss of one coal conveyor out of two conveyor systems supplying coal to a power station.
 - Rain causing wet coal, leading to reduced and unreliable generation at one or more power stations, or major disruptions to coal deliveries via trains.
 - Problems with ash handling plant, requiring a reduction in generation at a power station or the shutdown of multiple generating units.
 - Scarcity of boiler feed water (demineralised water) during flooding, requiring a reduction in generation or inability to continue generating.

¹¹⁸ See https://aemo.com.au/-/media/files/electricity/nem/planning_and_forecasting/nem_esoo/2023/2023-electricity-statement-of-opportunities.pdf.

¹¹⁹ As detailed in Section 6.4.1, USE represents energy that cannot be supplied to consumers when demand exceeds supply under certain circumstances, resulting in involuntary load shedding (loss of customer supply) in the absence of out of market intervention. The IRM is a measure of expected USE in any region of no more than 0.0006% of energy demanded in any financial year. On 25 May 2023, the AEMC released a final report recommending that the application of IRM to the RRO be extended to 30 June 2028.

- Scarcity of cooling water during droughts.
- Gas supply limitations due to failures at gas plant such as the explosion of Longford on 25 September 1988 and/or gas pipeline/compressor failures.
- Hydro power stations:
 - Low reservoir water levels during droughts.
 - Inability to generate at capacity due to limitations of downstream water releases in avoiding downstream flooding during extreme rainfall periods.
 - Inability to generate at full capacity due to downstream reservoir air space limitations (licence restrictions limit water releases during certain months of the year).
- Other causes:
 - Unplanned network outages requiring reduction of large amounts of IBR causing supply reliability issues.
 - NEM-wide low wind/solar generation for consecutive days (as occurred in June 2022).
 - Unplanned outages of the elements of interconnectors that cannot be restored during planned outages of elements of the same interconnector.
 - Loss of common station services such as compressed air, loss of station services transformers.

In particular, the majority of NEM gas plants do not have on-site gas storage and instead rely on natural gas supplied continuously through the gas network as their primary fuel source. As part of the 2023 EAAP, a minority (13% by capacity) of gas generators advised having access to an average of 18 hours of gas storage, predominantly through access to local linepack that is within the control of the operator. Most gas generators do not have secondary fuel capabilities. Of the generators which have diesel as a secondary fuel source, the diesel storage was expected to be suitable for an average of 12 hours of operation. For those generators that use diesel only, on-site storage was advised to be suitable for an expected 24 hours of operation on average.

Furthermore, there is an increasing need for gas generation to operate differently than it has historically – gas units need to be able to run for many days in winter when there is low wind and solar conditions, rather than peaking for short periods in summer. Therefore, there is a need for more on-site gas storage, as generators cannot only rely on the gas transmission system, which is already constrained, to be able to operate for these longer periods of high-price conditions.

6.6 Remedial action scheme interactions and maloperation risks

RASs are protection schemes in the NEM that operate automatically to prevent adverse outcomes following certain credible and non-credible contingency events. There are several RASs currently enabled in the NEM that provide a wide range of benefits to the power system including, but not limited to, minimising the impact of system incidents, and improving asset utilisation.

While RASs are critical to manage risks in the power system, they must be properly designed and periodically reviewed to ensure that they operate effectively and as intended. RASs have the potential to exacerbate the severity of an event or lead to cascading failures and supply disruptions if they fail to operate as expected. As

such, AEMO (in collaboration with NSPs) published the RAS Guidelines¹²⁰, which define the requirements for developing RASs in the NEM. The guidelines define good practice for design, modelling, and review of RASs to ensure that they meet their performance requirements and maintain their effectiveness under a wide range of operational conditions, as well as adapting to power system changes over time.

The Guidelines outline RAS design considerations, accounting for the potential failure modes, unintended operation, and inadvertent interactions. RASs have the potential to either fail to operate, or operate in unintended or unexpected ways due to equipment failure, an error, or a limitation in the scheme design. If a RAS does not respond as and when expected, this introduces additional risk to the power system. This means considering possible failure modes in the RAS design stage is essential to inform its proper design and testing.

In addition, inadvertent interactions between different RASs and/or other protection schemes can cause undesirable outcomes and add unnecessary complexity to the operation of the power system. Proper coordination with existing protection systems, backup schemes (if applicable), and other RASs is imperative to prevent these inadvertent interactions.

As such, it is increasingly critical for NSPs to engage in extensive and detailed joint planning in the design and testing of RASs to ensure that all existing and future RASs operate effectively and do not cause adverse interactions or exacerbate non-credible contingency events. For example, a finding from the 2022 PSFRR and 2023 GPSRR studies of non-credible generation contingencies leading to QNI instability and South Australia separation at Moorabool was that for scenarios where the SAIT RAS actions are not able to prevent a large power swing on PEC, this could lead to the tripping of PEC and the synchronous separation of South Australia, as well as the tripping of QNI and the synchronous separation of Queensland. Therefore, the results showed that Moorabool separation can possibly cause loss of stability on QNI, which could be exacerbated by the actions of existing RASs within Victoria and the SAIT RAS due to the total generation disconnected.

As part of the 2023 GPSRR, given the potential for Moorabool contingency events to result in separation of the mainland NEM into four islanded areas – Queensland, South Australia (separated at Heywood following Emergency Alcoa-Portland Potline Tripping (EAPT) operation), the network between Heywood and Moorabool (not a viable island) and the rest of New South Wales and Victoria – AEMO recommended that AEMO, AVP, ElectraNet and Transgrid continue collaborating as part of the PEC System Integration Steering Committee (SISC) to ensure that the SAIT RAS operates effectively in conjunction with existing NEM system protection and generation tripping schemes, as well as any future QNI SPS and other protection schemes.

Another example is the Waratah Super Battery (WSB) project, which is a priority transmission project in New South Wales and includes a SIPS to increase transfer capacity from central New South Wales to southern New South Wales. The SIPS will be provided by a BESS located at the former Munmorah coal-fired power station that is capable of providing a guaranteed continuous active power capacity of at least 700 MW and a guaranteed useable energy storage capacity of at least 1,400 megawatt hours (MWh) that discharges following a contingency event impacting a set of monitored transmission lines, thereby providing a virtual transmission solution that unlocks latent capacity in the existing transmission system. The SIPS will also comprise generation services provided by multiple generators across New South Wales that are capable of providing technical services to support the SIPS. Network Augmentations and SIPS Control will be provided by Transgrid in its role as Network

¹²⁰ See <https://aemo.com.au/energy-systems/electricity/national-electricity-market-nem/system-operations/remedial-action-scheme-guidelines>.

Operator that includes the SCADA, telecommunications, minor augmentations and control scheme equipment required to operate the SIPS. The failure or maloperation of this future scheme could result in the thermal overloading of multiple large transmission lines in New South Wales. Additionally, the tripping or running-back of generation by the SIPS could directly impact system reserves and cause swings on regional interconnectors, in particular QNI.

Therefore, this growth in the number of RASs and the scale of generation and/or load they trip will increase power system operational complexity and increase the risk of maloperation or unintended interactions between schemes across NEM regions. To manage this risk, AEMO recommends that NSPs in collaboration with AEMO engage in extensive and detailed joint planning in the design and testing of RASs that impact other NEM regions/inter-regional interconnectors to ensure that all existing and future RASs operate effectively and do not cause adverse interactions or exacerbate non-credible contingency events. This includes anticipated schemes such as the WSB SIPS, SAIT RAS and QNI SPS. Additionally, to assist with industry transparency, AEMO will develop a Special Protection Scheme summary information page containing details of all NEM SPSs, similar to what exists for other system operators such as Transpower¹²¹.

Recommendation 9

Given the growing number and complexity of NEM RASs, AEMO recommends that, as part of the existing obligations under NER S5.1.8 and S5.14, NSPs in collaboration with AEMO engage in extensive and detailed joint planning. In the design and testing of RASs, the impact on other NEM regions/inter-regional interconnectors should be considered to ensure that all existing and future RASs operate effectively and do not cause adverse interactions or exacerbate non-credible contingency events. This includes anticipated schemes such as the Waratah Super Battery (WSB) SIPS, South Australia Interconnector Tripping (SAIT) RAS and QNI SPS.

Given the increasing consequences of non-credible events, AEMO plans to review the RAS guidelines to ensure adequate guidance is provided regarding:

- Provision of limit advice associated with operational conditions where emergency controls are ineffective.
- Consideration of system strength impacts.
- Consideration of anticipated generator retirements.
- Requirement for NSP joint planning under 5.14.

Network RAS commissioning and testing

As described above, RASs have the potential to either fail to operate, or operate in unintended or unexpected ways due to equipment failure, an error, or a limitation in the scheme design. If a RAS does not respond as and when expected, this introduces additional risk to the power system and has the potential to exacerbate the severity of an event or lead to cascading failures and supply disruptions if they fail to operate as expected. Therefore, given the impact a network RAS can have on the system, actual system tests should be used wherever possible to validate the performance and design of a RAS during the commissioning process.

¹²¹ See <https://www.transpower.co.nz/our-work/industry/our-grid/grid-capability-and-configuration/special-protection-schemes>.

Fingrud Olkiluoto 3 fault ride-through test

For example, in Finland, Fingrid arranged a separate live system fault ride-through test of the Olkiluoto 3 plant on 29 November 2023 to ensure its capability of producing electricity in the event of a brief, transient fault¹²². Olkiluoto 3 is the largest individual power plant unit in the Nordic electricity system, so in terms of the functionality of the electricity system it was important to ensure that the power plant operates stably and reliably in various situations, including faults in the grid.

For the fault ride-through test, Fingrid changed the connection of the main grid in Western Finland to ensure the test had a minimal impact on other customers connected to grid – due to the abnormal switching state, it was necessary to limit the volume of wind power production on the west coast during the test. The fault ride-through test was carried out after the power change tests at full power of Olkiluoto 3 but before starting commercial operation, and during the test, Olkiluoto 3 produced electricity for the main grid. The test involved creating a momentary short circuit in the grid near the power plant, thus causing a similar drop in voltage that would occur in the event of a real fault resulting from, for example, a lightning strike in the vicinity of the power plant.

During the test conducted by Fingrid on 29 November 2023, Olkiluoto 3 automatically disconnected from the main grid while it was generating 1,720 MW as a result of a turbine trip lock occurring. This outcome demonstrates the value of actual system tests, as this ride-through issue was not identified through the offline dynamic simulations completed prior to the test.

RAS Guidelines

In the NEM, the RAS Guidelines provide a general overview of the basic requirements for RAS testing and commissioning. These requirements are detailed in the table below.

The relevant NSP should coordinate with affected parties to design, install, test, document, maintain and review the RAS in line with its obligations and internal procedures. Table 30 is not comprehensive and test requirements should be defined on an individual scheme basis, and may include point to point testing, hardware in the loop testing, bench testing etc.

Table 30 RAS testing guidelines

Consequence rating	1	2	3	4	5
Testing Guide					
Hard Test	To the extent practical	Where practical			
Functional Test	✓	✓	✓	✓	✓
Timing Test	✓	✓	✓	✓	✓
Secondary Test	✓	✓	✓	✓	✓
Commissioning Test	✓	✓	✓	✓	✓

The Guidelines state that, where possible, actual system tests should be used, and where system tests are not possible due to the size of the impact or the inability to set up the required conditions, hardware in the loop testing, offline testing and point to point testing with increased monitoring may be appropriate.

¹²² See <https://www.fingrid.fi/en/news/news/2023/olkiluoto-3-disconnected-from-the-grid-in-a-fault-ride-through-test/>.

As demonstrated by the Fingrid example above, for RASs that relate to network elements, testing often requires the system to be in a particular state. Additionally, the impact to the system of the maloperation or unintended operation of a RAS during testing may be severe. However, it is likely that the impact of a RAS maloperating or failing to operate during critical operating conditions because its performance was not verified through actual system testing during commissioning is far more severe.

AEMO recommends that, in accordance with the RAS Guidelines, actual system tests be used during RAS commissioning wherever possible to minimise the risk of maloperation, operation failure or unexpected system interactions.

6.7 Interconnector drift

Interconnector drift is when interconnectors have higher or lower flows than expected from the National Electricity Market Dispatch Engine (NEMDE) dispatch. This can occur when inputs to NEMDE (such as forecasts of demand, or wind and solar generation output), differ from the actual demand changes, wind and solar outputs and generator ramping actions experienced in the real power system. If generation or load in one region is mismatched due to this difference, the interconnectors will drift as the energy deficit is met by generation or load in neighbouring regions. Dispatch constraints include operating margins to allow for the uncertainties in these factors, but the interconnector drift may still temporarily move the interconnector flow above its nominal ratings. Interconnector drift may be present across multiple dispatch intervals because NEMDE allows for persistent off target outcomes, as long as it is possible to correct it within five minutes. Additionally, NEMDE dispatches the energy market within the secure interconnector limits, but not the FCAS markets – therefore, there is a possibility that interconnector flows exceed secure limits due to FCAS dispatch. Prior to the NEM, tie-line control¹²³ was used to control interconnector drift, but with the introduction of five-minute dispatches it was believed that the dispatch intervals were sufficiently short to manage the issue of interconnector drift.

Interconnector drift is a symptom of the main issue that VRE generators can be off target within a five-minute dispatch. There is currently no penalty for semi-scheduled plants being significantly under target, and the aggregated difference can result in interconnector drift of 150 MW to 200 MW. Interconnector drift is currently most evident across the Heywood interconnector, and the flow being up to 200 MW above target could expose the South Australia system to unnecessary risks in the event of contingencies. Other NEM interconnectors do not yet experience the same magnitude of drift as the Heywood interconnector, but as more VRE comes online in future, this issue could become more prevalent in other parts of the NEM.

In South Australia, the constraints that limit Heywood flow in NEMDE contain dynamic headroom, which updates based on the interconnector drift measured in the last dispatch interval. The dynamic headroom reduces the right-hand side (RHS) limit of the constraint on Heywood flow by a maximum of 50 MW based on the amount the flow exceeded the limit in the last dispatch interval if the exceedance was greater than 10 MW. For example, if the current Heywood export limit is 550 MW, and the flow in the last dispatch interval was 580 MW, the dynamic headroom reduces the limit to 520 MW. In 2023, the constraint formulations were updated to use the maximum interconnector flow from the previous dispatch interval, rather than the initial value, to calculate the limit

¹²³ The transmission lines that connect a region to neighbouring regions are called tie-lines. Power sharing between regions occurs through these tie-lines. Load frequency control regulates the power flow between these interconnected areas over the tie-lines while holding the frequency constant.

exceedance. This change makes the constraints more dynamically responsive, and overall improved performance has been observed with few periods of violating Heywood constraints in the last 12 months. However, if VRE generators are persistently under target for multiple dispatch intervals, there is still a risk of significant interconnector drift.

In the GPSRR, the risk of interconnector drift is accounted for by assessing boundary conditions for non-credible contingency events including instances of higher interconnector flows. Additionally, as detailed in Section 5.4, the proposed PEC Stage 1 destructive wind limits of 430 MW for Heywood and 70 MW for PEC were calculated assuming that up to 100 MW of interconnector drift may occur – these limits ensure that the interconnector satisfactory limits are maintained for a contingency size of 500 MW and allows for at least 100 MW of headroom for interconnector drift.

6.8 Power system modelling improvements

AEMO uses modelling data and simulation models to assess technical performance standards and to determine power system operational limits. In the operations timeframe, AEMO requires real-time modelling tools to ensure that power system security is maintained for all credible contingency events. In the planning timeframe, offline power system modelling is used to formulate system constraints/limits, design SPSs, and specify power system requirements, as well as to assess the connection requirements for future generators.

Accurate power system modelling requires high quality data as well as correct parameterisation. Appropriate modelling tools also need to be selected for simulating the power system phenomenon being assessed. As such, the reliance on power system modelling/simulation for the planning and operation of the NEM results in several significant operational risks. Non-representative power system models could directly lead to the inaccurate calculation of power system limits or failed runs of operational contingency analysis tools. Without accurate limits/constraints and real-time contingency analysis tools, power system security cannot be maintained. In the planning timeframe, if the model of the power system is inaccurate and diverges as new resources are added, this would lead to the loss of forecasting capability for system incidents. Additionally, it would not be possible to accurately define the technical envelope of the power system for future operating conditions, including planning for higher penetrations of IBR/the energy transition.

For example, in 2019, sustained post-disturbance voltage oscillations with a dominant frequency of 7-12 Hz¹²⁴ were observed in EMT simulations in the West Murray Zone¹²⁵. These oscillations were identified in AEMO's studies¹²⁶ to be mainly caused by a few IBR in the area, following the loss of a transmission line. The simulated oscillations were proven to be real later in 2019, through staged tests on the actual network. AEMO's studies also showed that by limiting the active power dispatch of these IBR alone, the magnitude of oscillations cannot be adequately reduced. Hence, a constraint on the number of online inverters was applied for the IBR involved, which was shown in the simulations to be effective in limiting the magnitude of post-disturbance voltage oscillations to an

¹²⁴ All frequencies mentioned in this report refer to measurements based on root mean square (RMS) power system quantities, primarily voltage. The instantaneous three-phase waveforms would have frequencies in the range of $50 \pm$ (observed RMS frequencies) Hz.

¹²⁵ See https://aemo.com.au/-/media/files/electricity/nem/network_connections/west-murray/west-murray-zone-power-system-oscillations-2020--2021.pdf?la=en.

¹²⁶ A. Jalali, B. Badrzadeh, J. Lu, N. Modi, and M. Gordon, "System strength challenges and solutions developed for a remote area of Australian power system with high penetration of inverter-based resources," Published in CIGRE Sci. Eng. J., pp. 27–37, Feb. 2021.

acceptable level. This incident therefore illustrates the importance of accurate power system modelling in maintaining power system security.

To mitigate the risks associated with power system modelling, there are a number of ongoing initiatives consistent with AEMO's risk management methodology as described in Section 1.5.2:

- The Power System Modelling Reference Group (PSMRG) is a technical expert reference group which focuses on power system modelling and analysis techniques and information sharing to support various NEM modelling activities. The PSMRG aims to provide a consistent basis for the modelling of NEM and WEM and establish procedures and methodologies for power system analysis, plant commissioning and model validation and share knowledge on emerging power system issues.
- The Operations Technology Program has been initiated to uplift AEMO's control room technical capability in line with the rules and regulations¹²⁷. It will leverage technological innovations, uplift systems, invest in advanced analytics and forecasting capabilities and support near real-time decision-making. The program will enable AEMO to better manage increasing complexity, larger data sets and more frequent significant events to meet the ongoing needs of the Australian energy system through the implementation of an extensive program of operational tools projects and initiatives.
 - As part of the 2023 GPSRR, in the context of the transforming power system and changing risk profile of the NEM, AEMO recommended that all NSPs, where not already doing so, evaluate current and emerging capability gaps in operational capability, encompassing online tools, systems and training.
- The Operations Simulator will ultimately be a fast online EMT contingency analysis tool to aid control room decisions, and was a project identified as part of the Operations Technology Program.
 - As detailed in Section 6.4.4, there is currently no real-time EMT analysis tool available to analyse system voltage stability and system strength. This means that there is a risk it could take AEMO longer than 30 minutes to resecure the system following a contingency event impacting system strength, due to the time it takes to complete EMT studies.
 - To address this risk, as part of the Operations Simulator project, AEMO is currently working with vendors to improve the speed and capabilities of EMT simulation tools¹²⁸, thereby enabling management of system strength in the operational timeframe.
- AEMO is performing ongoing validation of the AEMO PSS®E composite load model (CMLD) and DER models against real events¹²⁹.
- AEMO CMLD and DER models are being developed for PSCAD™¹³⁰.
- UFLS modelling is being improved, including through integration of NSP mapping data – see Section 6.2.
- AEMO is in the early stages of initiating a project to implement a real-time frequency contingency analysis tool.

¹²⁷ See <https://aemo.com.au/en/initiatives/major-programs/operations-technology-program>.

¹²⁸ See <https://aemo.com.au/en/initiatives/trials-and-initiatives/real-time-simulator>.

¹²⁹ See <https://aemo.com.au/-/media/files/initiatives/der/2022/psse-models-for-load-and-distributed-pv-in-the-nem.pdf?la=en>.

¹³⁰ See reports at <https://aemo.com.au/initiatives/major-programs/nem-distributed-energy-resources-der-program/operations/power-system-model-development>

- AEMO has developed a model issues reporting page and process in collaboration with TNSPs.
- AEMO is currently undertaking an initial audit of its Releasable User Guide (RUG) database compared to OPDMS.
- AEMO and NSPs are developing a prioritised workplan for model uplift initiatives.
- AEMO models benchmarking initiatives using high speed monitoring (HSM) data from recent significant power system events.
 - As detailed in Section 6.4.4, AEMO will also leverage the increased system monitoring capabilities (through the PMU rollout and WAMS) for ongoing power system model validation.

Additionally, the *Engineering Roadmap to 100% Renewables*¹³¹ is tracking several additional power system modelling initiatives relating to the uplift in modelling capabilities required to model power system requirements for 100% IBR system.

6.9 Weather-related risks

Weather events have the potential to cause major supply disruptions to the NEM either by:

- causing a non-credible contingency,
- limiting the output of a group of generators or technology type, or
- constraining the network between generation and load centres.

Operational forecasting

Weather is playing an increasingly critical role as a fuel source for renewable electricity supplies, especially given the increasing penetration of VRE generation as detailed in Section 2.1. Weather can significantly impact the output of VRE generation such as wind and solar farms. A wind farm cannot generate without wind, while a solar farm cannot produce electricity without irradiance from the sun. Additionally, there is the possibility of large generation ramps in response to fast changes in weather conditions, such wind gusts/lulls for wind generation and cloud formation for DPV and solar generation.

As part of the 2022 PSFRR¹³², AEMO assessed historical generation ramping events in South Australia. Due to the penetration of DPV and transmission-connected IBR, South Australia is becoming more susceptible to large generation ramping events. Through this analysis, AEMO identified ramping events in South Australia in 2021 where the combined DPV and IBR generator output reduced by over 1,750 MW over 2.5 hours.

Therefore, since weather is highly variable and uncertain, forecasting weather-influenced generation and demand has become essential to maintaining a secure and reliable electricity grid. Other factors that come into play in forecasts include temperature, humidity, cloud distribution, dust and sandstorms, bush fire smoke, lightning, rain, tornados, and cyclones. Even rare celestial events such as solar eclipses have to be planned for when maintaining

¹³¹ See <https://aemo.com.au/initiatives/major-programs/engineering-roadmap>.

¹³² See https://aemo.com.au/-/media/files/stakeholder_consultation/consultations/nem-consultations/2022/psfrr/2022-final-report---power-system-frequency-risk-review.pdf?la=en.

the supply-demand balance. Additionally, times of the day, days of the week, seasons and holidays can impact demand on the system and are incorporated into AEMO's forecasts. In maintaining secure, reliable and affordable power systems, it is critical to understand how all these variables interplay.

Roughly, AEMO produces more than 3 million point-forecasts a day. In gathering data from rooftop solar, as well as wind and solar farms, AEMO uses specialised forecasting systems. These systems use a combination of statistical and physical forecast models to predict electricity demand, and energy output from rooftop solar, as well as wind and solar farms. In generating its forecasts, AEMO collates data from many sources, including global weather models, satellite imagery feeds, and numerous weather forecast providers covering 520 weather stations around the country, along with market participants' own on-site weather stations at their respective wind or solar farm. The Australian Wind Energy Forecasting System (AWEFS) and Australian Solar Energy Forecasting System (ASEFS) use numerical weather prediction data, real-time VRE SCADA measurements (updated 4-10 s) and availability information submitted by participants to produce wind and solar generation forecasts in the dispatch, pre-dispatch and short-term (ST) PASA timeframes. AEMO's Demand Forecasting System (DFS) creates demand forecasts for each region of the NEM, and predicts how demand will change under certain conditions including accounting for DPV.

In the NEM, AEMO also uses an advanced model to produce the Forecast Uncertainty Measure (FUM) that incorporates more than 1 billion forecasts and is underpinned by Bayesian Belief Networks (BBN). These forecasts are used to 'train' the FUM model based on historical errors and conditions that were present at the time the projection was produced. This model is retrained quarterly. The FUM increases based on uncertainty in IBR generation capacity due to changing weather conditions, which effectively increases the system reserve requirements – such as for the large generation ramping event in South Australia described in the 2022 PSFRR. This information flows into AEMO's forecasting systems every minute of every day and is collated and fed into AEMO's models, which are becoming more complex, with new capabilities.

AEMO produces longer-term outlooks, and numerous shorter-term forecasts including the one-week-ahead ST PASA. These ST PASA forecasts are further refined as they get closer to dispatch time (AEMO's final direction to generators) and are updated at intervals from the day ahead through to five-minute pre-dispatch (5MPD), and finally dispatch.

With the energy transition gaining momentum and an increasingly weather sensitive power system, AEMO continues to build and refine its forecasting capabilities to improve situational awareness and manage risk through the following initiatives:

- The AEMO Operational Forecasting Fusion project aims to implement the world's best practice in operational forecasting that will enhance the capacity and capability of AEMO's demand, wind, solar and DPV forecasts, to improve system and market operations. Fusion is reducing operational risk by upgrading or replacing forecasting systems, such as the demand forecast system and the FUM and implementing an in-house variable renewable energy forecasting system (VREFS) for wind/solar generation forecasting.
 - In FY2023, (Action ID A15 in the Engineering Roadmap¹³³) Operational Forecasting implemented a Productionised R environment that facilitates more rapid and resilient development and deployment of forecasting tools. The new in-house VREFS has been designed and deployed for dispatch forecasting, with

¹³³ See <https://aemo.com.au/-/media/files/initiatives/engineering-framework/2023/nem-engineering-roadmap-fy2024--priority-actions.pdf?la=en>.

ongoing work to design and develop forecasting models for pre-dispatch and ST PASA. This will enable more rapid updates in near-term forecasts for VRE generation and will facilitate future changes to AWEFS and ASEFS via the Fusion Project.

- In line with the deployment of VREFS, the demand forecasting equivalent, XDEMTOD, has also been redesigned and reconfigured to facilitate enhanced agility and future Fusion project works. The enablement of bid MaxAvail for semi-scheduled generators in August 2023 provides additional functionality to VRE generation participants to submit their generator availability to improve dispatch, pre-dispatch and PASA outcomes.
- There is an FY2024 priority action in the Engineering Roadmap to deploy weather monitoring infrastructure to support participant and AEMO forecasting requirements for REZs, DPV generation within load centres and other key network locations. This initiative involves collaboration between the Bureau of Meteorology and AEMO to develop a sustainable business model for acquiring, curating and releasing new weather observations that will provide enhanced nowcasts and forecasts for the energy sector. This aims to improve the management of the energy system, VRE generation and prospective REZs.

These initiatives are important for market efficiency and critical to the secure operation of the power system now and into the future.

Reclassification framework

To manage risks associated with abnormal weather conditions, AEMO can reclassify non-credible events as credible and invoke the relevant constraints to ensure the system lands in a satisfactory operating condition. AEMO updated the reclassification criteria in the Power System Security Guidelines¹³⁴ (SO_OP_3715) following the indistinct events rule change¹³⁵. The update to SO_OP_3715 provides an expanded reclassification framework to assess the risks posed by various types of weather events including:

- Bushfires.
- Lightning threats to double-circuit transmission lines.
- Severe wind (including tropical cyclones).
- Geomagnetic disturbances (GMD).
- Floods.
- Widespread pollutants.
- Landslides.
- Earthquakes and tsunamis.
- Solar eclipse.

¹³⁴ At https://www.aemo.com.au/-/media/Files/Electricity/NEM/Security_and_Reliability/Power_System_Ops/Procedures/SO_OP_3715%20Power-System-Security-Guidelines.pdf.

¹³⁵ See <https://www.aemc.gov.au/rule-changes/enhancing-operational-resilience-relation-indistinct-events>.

In each case, the updated criteria outline AEMO’s considerations in deciding to reclassify a non-credible event as credible based on the threat posed. It is important to highlight that the revised reclassification framework allows AEMO to put controls in place to manage a wider range of conditions, increasing AEMO’s overall ability to maintain power system security. SO_OP_3715 also includes a summary of the measures AEMO may take following reclassification in response to the weather risks listed above.

As part of the update to SO_OP_3715, AEMO developed a criteria checklist to facilitate the decision-making process and manage power system security in the unlikely event of a GMD forecast which is large enough to adversely affect the power system. The Bureau of Meteorology’s Space Weather branch¹³⁶ (IPS Radio and Space Services) has developed a Severe Space Weather Service (SSWS) aimed at forecasting severe space weather events considered most hazardous to critical infrastructure such as the Australian power system. The model produces forecasts (watch messages) based on solar data only (providing lead times > 12 hours) and updated forecasts with increased probability that utilise additional solar wind data but with a decreased warning lead time of only 30-60 minutes. The AEMO checklist considers the notifications from SSWS for both warning and watch events and the available lead time before the storm reaches earth, and defines the corresponding potential AEMO actions.

As detailed in SO_OP_3715, AEMO acknowledges that cloud cover events cannot be actively managed in a targeted manner through the existing real time operational processes and systems. Further work is required in collaboration with the Power System Security Working Group (PSSWG) and wider energy industry to identify and evaluate technological developments that could enable real time management of sudden changes in solar generation output, for example to:

- Automatically flag oscillating generation/load events on the power system.
- Track cloud cover location/size/movements through radar observation or other forecasting methods/alerts that may become available (such as monitoring of metro areas with large clusters of DPV, REZs and solar generation centres).

As such, AEMO Operational Forecasting is currently considering probabilistic mechanisms for cloud cover conditions, which the PSSWG can use to propose a deterministic reclassification process¹³⁷.

Recent South Australia lightning trips and transmission tower lightning protection

In 2023, there have been an increased number of transmission line trips caused by lightning in South Australia, such as on 7 June 2023 and 11 December 2023. Table 31 below summarises some of these recent contingency events.

Table 31 Summary of recent lightning trips in South Australia

Incident date	Number of trips due to lightning in South Australia
7 June 2023	6 trips in <4 hours
11 December 2023	27 trips in ~12 hours

¹³⁶ See <https://www.sws.bom.gov.au/?ref=fr>.

¹³⁷ See https://www.aemo.com.au/-/media/Files/Electricity/NEM/Security_and_Reliability/Power_System_Ops/Procedures/SO_OP_3715%20Power-System-Security-Guidelines.pdf.

Most of the contingency events that were caused by lightning in 2023 were not reviewable operating incidents or were credible and did not result in additional cascading failures or severe power system impacts. However, the high number of contingencies and line trips that occurred could indicate systemic issues – such as lightning protection on the transmission towers failing to prevent tripping – which are of significance to operation of the power system (NER 4.8.15(a)(3)).

Additionally, the same or very similar contingency events could have severe consequences depending on the power system operating conditions at the time that they occur. An example of the cascading failures that could occur following numerous trips due to lightning or storm conditions in South Australia and the implications for managing power system security is described below.

A multiple contingency event (caused by storm conditions or lightning) causing intra-regional South Australia separation

Pre-contingent South Australia operating conditions:

- Storm weather conditions led to high wind, low solar and low gas generation conditions in South Australia, subject to AEMO interventions such as constraints and/or directions.
- High wind generation caused high flows from northern South Australia to the rest of the NEM.
- South Australia was exporting to Victoria due to surplus generation.

Multiple contingency event:

- Tripping of the Robertstown and Para to Davenport cut set transmission lines due to storm conditions and/or lightning strikes in the area causing cascading intra-regional separation between northern South Australia and southern South Australia.
 - The northern South Australia island was disconnected from the rest of the NEM.
 - The “southern island” consisted of southern South Australia, Victoria, New South Wales and Queensland.
- AEMO Operations did not have time to respond using constraints and/or directions due to several contingency events occurring in quick succession.

Consequence and impact:

- Over frequency occurs in the northern South Australia island (due to excess wind generation), and under frequency occurs in the “southern island”.
- Due to the pre-contingent operating conditions, there are a low number synchronous units online in the northern South Australia island.
- The northern South Australia island fails to form a stable island and blacks out, causing the disconnection of the Davenport and Port Lincoln connected mining loads, and the loss of significant wind generation.
- The “southern island” remains operational, but there is potential for the NEM to separate into four islands as a result of this contingency – northern South Australia (likely not a viable island), southern South Australia, Victoria/New South Wales and Queensland:

- Flow on the Heywood interconnector reduces due to the loss of wind generation from northern South Australia. Large swings on Heywood could result in transient instability and the separation of southern South Australia from the rest of the NEM (refer to Section 6.14.2).
- QNI may lose stability if Queensland is exporting into New South Wales due to the effective loss of generation from northern South Australia.

Possible mitigation measures

Minimising the probability of multiple transmission line trips due to lightning in South Australia

- Remedial transmission tower works of critical and/or high-risk circuits.
- Monitoring of asset conditions and review of control settings to reduce the probability of maloperation and/or faults.

Minimising the impact of multiple transmission line trips due to lightning in South Australia

- Reclassification of at-risk transmission lines in accordance with SO_OP_3715.
 - Wider reclassification due to tower design weakness constraining generation/flows from northern South Australia, thereby reducing the severity of intra-regional separation.
- Implementation of a new RAS to manage South Australia intra-regional separation.

Recommendation 10

To reduce the number of transmission line trips due to lightning in South Australia, AEMO recommends that ElectraNet investigate South Australia transmission tower earthing and lightning protection based on recent contingency events to identify or rule-out any existing design weaknesses. For example, on 11 December 2023 there were 27 trips in South Australia due to lightning in ~12 hours.

Additionally, consistent with NER 5.20A.1, AEMO has identified the potential need for a RAS to manage South Australia intra-regional separation. Therefore, to reduce the likelihood that multiple trips due to lightning or other risk factors in South Australia result in severe cascading failures, AEMO recommends, in accordance with NER S5.1.8, that ElectraNet investigate the suitability of a RAS to prevent South Australia intra-regional separation.

6.10 Failure of SCADA systems

Between January 2021 and November 2023, there were five significant (resulting in loss of AEMO NEM SCADA or regional market suspensions) and 13 potentially significant SCADA-related incidents across the NEM.

As summarised in Section 3.2.2 of this report, AEMO has investigated these 18 incidents to identify potential systemic issues of significance to the NEM. A critical finding of AEMO's investigation was that in 16 of the 18 incidents, redundant systems had failed to respond in line with expectations. In many of the incidents considered, effective redundant systems would have prevented a full SCADA failure and minimised the incident's impact.

As reliable SCADA is critical for power system operators to maintain power system security, operate the NEM and maintain operational awareness, AEMO considers that the recent trend of an increasing number and growing

impact of SCADA incidents poses a significant and unacceptable risk to power system operations which must be urgently addressed. Therefore, to improve NEM-wide SCADA resilience AEMO recommends that all TNSPs, DNSPs and participants who input to or operate SCADA systems in the NEM:

- Review existing automated backup and failover system testing procedures and identify opportunities for improvements. Automated backup, failover and redundant system test procedures should focus on testing non-standard/challenging failovers to replicate challenging real world conditions wherever possible. Any deficiencies identified should be rectified promptly.
- Review all recommendations identified in the published reviewable *Multiple Incidents Impacting NEM Scada between 24 January 2021 and 18 November 2023* reviewable operating incident report¹³⁸ and adopt any recommendations that are relevant to their own operations.

6.11 Substation hardening

Substation hardening involves proactively identifying critical sites/substations and implementing remedial measures to increase power system resilience against a wide range of threats. These threats could include severe weather (floods, storms, lightning, wildfires, etc.), human error, vandalism or physical attacks, cyberattacks and equipment failures. Substation hardening therefore allows for proactive resilience planning, by preparing the power system ahead of time for possible severe threats, rather than relying on a reactive crisis response.

For example, in March 2014, the NERC implemented CIP-014-1 guidelines¹³⁹, which require transmission owners to assess the vulnerability of critical substations to physical attacks and develop and implement security plans containing suitable protective/hardening measures.

Hardening measures can be employed in the design/building of new substations but can also be implemented through the retrofitting of existing infrastructure. Substation hardening can/may involve the following operational, design and equipment hardening measures:

- Operational measures – such as site fencing, alarm systems, site surveillance, lighting, communication redundancies, regular cleaning of the affected components can prevent deposits of contamination.
- Design measures – reconfiguring substations to limit the impact of an event.
- Equipment – dry bushings, redundant transformer cooling, pergola roofs for power transformers to reduce direct solar irradiation, reflective coatings to combat the effect of external heat sources on the polyvinyl chloride (PVC) and polymer materials.

AEMO recommends that NSPs assess the physical security of critical substations, considering a wide range of threats, and evaluate cost-effective remedial measures for any vulnerabilities identified.

¹³⁸ At https://aemo.com.au/-/media/files/electricity/nem/market_notices_and_events/power_system_incident_reports/2023/multiple-incidents-impacting-nem-scada-between-2021-and-2023.pdf?la=en.

¹³⁹ See https://www.nerc.com/pa/Stand/Prjct201404PhsclScrtty/CIP-014-1_Physical_Sec_draft_2014_0409.pdf.

6.12 Communication-related risks

The risk of losing communications infrastructure is becoming more significant with the increasing interconnectedness of the power system and reliance on communications for a greater number of critical functions. Communications are essential for the monitoring and dispatch of generators and loads, aggregation of distribution level DER, market functions and operation of protection schemes. As new technology is integrated into the grid, the communications required for it to operate introduce new and increasing risks if failure were to occur. Loss of communications infrastructure has the potential to result in significant impacts across both the transmission and distribution networks and must be considered in regard to the changing power system as part of the energy transition.

One emerging communications risk that is present in the distribution network is new technologies that rely on communications infrastructure to aggregate the response of many consumers, such as VPPs and the aggregation of DPV and load response. Aggregation of DER often uses communications that are largely reliant on single-vendor links through the mobile network or through home internet connections such as the National Broadband Network (NBN). This could cause significant issues in situations where DER is providing significant proportions of system security services and represents a large potential risk that a common communications failure could significantly reduce the available services. The loss of a major telecommunications provider, similar to the incident that occurred with the Optus outage on 8 November 2023, could result in significant impacts on the network if DER aggregation was providing key services at the time.

There is also a need to establish robust communications and cyber security standards when implementing new technologies that could have large operational impacts on the NEM. This is currently being considered in Project Edge¹⁴⁰ and Project Symphony¹⁴¹, which are trials of VPP operation currently in place in Victoria and the WEM respectively. The key objective of these trials is to understand how the full capabilities of DER can be utilised while maintaining a safe, reliable and efficient power system, which requires that scalable and secure data exchange is enabled.

At the transmission level, the failure of key communications links can have a significant impact on the operation of the power system. This was demonstrated by the market suspensions on 17 March 2023 in New South Wales¹⁴² and on 22 April 2023 in Victoria¹⁴³ that were declared due to the loss of SCADA. Without full oversight of the outputs of generators in New South Wales or Victoria, NEMDE assumes generators are operating at the dispatch target used for the previous trading interval, which may not be correct. In addition to this, for the New South Wales SCADA outage, generators in New South Wales connected to the Transgrid SCADA were unable to receive Automatic Generation Control (AGC) signals for regulation frequency control ancillary services (FCAS) from AEMO via Transgrid.

Protection schemes are also heavily reliant on communications and will be increasingly important for the operation of new REZs, enabling higher flows on interconnectors and preventing cascading failures throughout the power

¹⁴⁰ See <https://aemo.com.au/en/initiatives/major-programs/nem-distributed-energy-resources-der-program/der-demonstrations/project-edge>.

¹⁴¹ See <https://aemo.com.au/en/initiatives/major-programs/wa-der-program/project-symphony>.

¹⁴² See https://aemo.com.au/-/media/files/electricity/nem/market_notices_and_events/market_event_reports/2023/final-report---nsw-market-suspension-17-march-2023.pdf?la=en.

¹⁴³ See https://aemo.com.au/-/media/files/electricity/nem/market_notices_and_events/market_event_reports/2023/preliminary-report-vic-market-suspension.pdf?la=en.

system (as discussed in Section 6.14.1). Protection schemes operate with precise timing requirements and any loss of communications could result in significant impacts. It is important to consider redundancy of communications infrastructure, the resilience of such systems, and ensuring appropriate cyber security standards are implemented so that the risks of loss of communications can be mitigated.

6.13 Cyber-related risks

Since 2023, as part of the GPSRR, AEMO has purposefully included cyber-related risks that could affect the Australian power grid's reliable operation. As the power system moves towards incorporating internet-connected devices, including renewable generation, and to a more decentralised grid, this will bring significant technological complexity as well as additional security considerations and an increased dependence on telecommunications to provide real-time telemetry and manage the power system security. Reliable energy supply underpins Australia's prosperity, making the energy sector a realised target for a range of cyber security adversaries.

Threat actors are actively developing attack methodologies to meet an increasingly complex and technologically evolved attack surface that could not be envisaged when AEMO was first established in 2009. According to the latest security advice from the Australian Signals Directorate (ASD) and its partner agencies, sophisticated and well-resourced threat actors are developing creating Industrial Control System (ICS) specific malware that is designed to enable large scale acts of sabotage prior to, or during war.

The reclassification criteria in the Power System Security Guidelines¹⁴⁴ (SO_OP_3715) now expressly include criteria for reclassification due to an actual or credible threat of cyber-attack. AEMO will decide whether non-credible contingency events involving multiple plant should be reclassified as credible due to cyber risk having regard to:

- Advice/alerts by Australian Cyber Security Centre.
- Cyber security advice received by AEMO Registered Participants and relevant customers.
- Potential scale of impact (for example, organisation-wide, industry-wide, primary or backup systems).
- Criticality of systems at risk.

The reclassification criteria provide for a range of possible measures to manage cyber-attack risk after reclassification, in Section 8.4.3 of the Power System Security Guidelines.

DER contingency considerations

DER is becoming increasingly integral to power systems, and any contingency modelling will invariably involve considerations of vulnerability due to cyber-attacks based on an increased attack surface and added system complexity. By their very nature, DER systems increasingly rely on internet-based communications for control and monitoring, and these interdependencies make them susceptible to cyber-attacks that target these communication networks.

¹⁴⁴ At https://www.aemo.com.au/-/media/files/electricity/nem/security_and_reliability/power_system_ops/procedures/so_op_3715-power-system-security-guidelines.pdf?la=en.

Within the Australian context, regulatory bodies and policy frameworks have sought to retrospectively apply cybersecurity considerations into the design, deployment, and operation of DER, due to public validation of the cyber risk. In particular, the Cybersecurity Co-operative Research Centre (CRC) highlighted the risk surrounding DPV systems with both command-and-control capabilities/vulnerabilities and concentration of country of origin.

However, the overwhelming majority of solar installations are controlled via the internet and Wi-Fi, not via the meter. Control via the meter involves providing the required function via an alternate mechanism that does not share a common mode of failure (the internet), which is preferable for market operators. This means if there is a compromise at the OEM or VPP system of the VPP or aggregator, the risk can be mitigated. Control of the system is then regained via the meter's capability to isolate and defend the risk (disconnect the solar via alternate mechanism not subject to the attack). This segmentation of the attack surface allows for recovery of the asset and reconnection to the system. However, more fundamentally, if the threat actor cannot be repelled and will retain control of the affected asset when it is reconnected, the system cannot recover. Additionally, the 2023 Optus outage demonstrated that there must be a secure system with the possible outage of communication to a large number of devices.

Internationally, there have been cases where critical infrastructure has been compromised via a common mode of failure, including:

- A cyber-attack against Denmark's energy infrastructure via a common firewall vulnerability in 2023¹⁴⁵.
- A cyber-attack on Ukraine's SCADA systems via acquired legitimate credentials in 2015¹⁴⁶.
- Malware infection at Stuxnet in 2010¹⁴⁷.
- Physical terrorism attack at San Jose substation in 2013¹⁴⁸.

The Institute of Electrical and Electronics Engineers (IEEE) and NERC have identified the increased risk of physical and cyber security threats in the evolving energy sector and recommended that transmission planners study the unique contingencies posed by cyber threats¹⁴⁹. They recommended that transmission planners identify transmission elements that share a cyber/physical security or communications related common mode failure (like DERs that share a common control system). Once these commonalities are identified, the transmission planner can develop contingencies that simulate an outage of elements connected via a security-based attack.

IEEE and NERC also noted a number of corrective action plans that can be used to mitigate the reliability risk of a power system due to such threats, including load shedding programs¹⁵⁰.

¹⁴⁵ SektorCERT (November 2023) The attack against Danish critical infrastructure, <https://sektorcert.dk/wp-content/uploads/2023/11/SektorCERT-The-attack-against-Danish-critical-infrastructure-TLP-CLEAR.pdf>.

¹⁴⁶ Electricity Information Sharing and Analysis Centre (March 2015) Analysis of the cyber-attack on the Ukrainian power grid, https://media.kasperskycontenthub.com/wp-content/uploads/sites/43/2016/05/20081514/E-ISAC_SANS_Ukraine_DUC_5.pdf.
Cybersecurity & Infrastructure Security Agency (July 2021) Cyber-Attack against Ukrainian critical infrastructure, <https://www.cisa.gov/news-events/ics-alerts/ir-alert-h-16-056-01>.

¹⁴⁷ IEEE (May 2011) Stuxnet: Dissecting a Cyberwarfare Weapon, <https://ieeexplore.ieee.org/document/5772960>.

¹⁴⁸ The Mercury News (August 2014) PG&E substation in San Jose that suffered a sniper attack has a new security breach, <https://www.mercurynews.com/2014/08/27/pge-substation-in-san-jose-that-suffered-a-sniper-attack-has-a-new-security-breach/>.

¹⁴⁹ IEEE and NERC (December 2022) Towards Integrating Cyber and Physical Security for a More Reliable, Resilient, and Secure Energy Sector; NERC (May 2023) Cyber-informed transmission planning, https://www.nerc.com/comm/RSTC_Reliability_Guidelines/ERO_Enterprise_Whitepaper_Cyber_Planning_2023.pdf.

¹⁵⁰ At https://www.nerc.com/comm/RSTC_Reliability_Guidelines/ERO_Enterprise_Whitepaper_Cyber_Planning_2023.pdf.

Proportion of DPV exposed

Most OEMs now have the ability to remotely connect to their devices in the field and can remotely control the unit, change settings, implement firmware updates, and so on. For this analysis it has been assumed that the proportion of new DPV installations that are internet connected has grown from almost none in 2017 to 75% in 2022.

Based on this, it is estimated that at present approximately 33% of the entire DPV fleet could be connected to the internet, and this is likely to grow to 43% by 2025¹⁵¹.

Furthermore, by 2025 it is estimated that around 30% of the DER fleet will be internet-connected, and associated with OEMs from a single country of origin (which may escalate risks of a common mode of failure). By 2027, this proportion increases to 35%.

Therefore, analysis of EFCS adequacy/requirements should include sensitivities with the tripping of up to 30-35% of regional DER generation, in particular if this corresponds to the largest possible contingency size in a region (for example, in South Australia for determination of EUFR requirements).

Cyber Defendable Core

One cyber risk mitigation proposed by AEMO is a Cyber Defendable Core (CDC), designed to ensure AEMO can operate power and gas systems in the face of a cyber-attack by improving capability to defend, withstand and recover more quickly.

Cyber protection is critical for all aspects of AEMO's functions, but a critical priority is the ability to operate the power system in the face of a cyber-attack. To achieve this, the proposed CDC will focus on energy security. This will involve an inner core that can keep the lights on and gas flowing in the face of a cyber event. This will be achieved by building a core of resilient infrastructure services and deploying existing critical systems into that core. The CDC is planned to enable AEMO to continue to run core systems in the event of a cyber-attack, such as:

- Control systems such as AGC, NEMDE and state estimation.
- Visibility of the network through SCADA.
- Supporting systems including alarms, EMS, contingency analysis and constraints management.
- Control room operations.
- Key critical telecommunication functionality.

With core systems intact, the CDC would enable AEMO to retain the functionality to keep the lights on and the gas flowing in the face of a cyber-attack. This would ensure that the grid can be restarted or continued to run with core functions that can be relied upon.

¹⁵¹ Assuming DPV will grow linearly to 2027 according to the *Step Change* scenario in the 2023 Inputs, Assumptions and Scenarios workbook. The estimation does not consider the replacement of old inverters with new inverters.

6.14 Other emerging risks

6.14.1 Management of maximum non-credible contingency sizes

The 2023 GPSRR commented on the increasing maximum credible contingency size in the mainland NEM, and the associated operational and planning challenges¹⁵². Similarly, the maximum (N-2)¹⁵³ non-credible contingency size is also increasing. For example, the Loy Yang CBF event studied as a priority risk in the 2024 GPSRR (refer to Section 1.2) could directly result in the loss of up to 1,300 MW of generation. However, based on operational experience, the loss of this amount of generation inevitably results in significant cascading failures, such as instability and the tripping of regional interconnectors (QNI), DPV shake-off (refer to Section 4.1.3), or the failure to ride through of additional online generators. Therefore, the total effective contingency size for such an event could potentially be in excess of 2,000 MW. Additionally, such a significant contingency event could have severe impact on regional system strength – see Section 4.1.1.

A recent example of this unexpected increased contingency size occurred when both Moorabool – Sydenham 500 kV lines tripped on 13 February 2024. This unexpectedly caused the disconnection of all four Loy Yang A generating units, resulting in the total loss of over 2,500 MW of generation (for more details, refer to Section 3.2.3). Similarly, the failure of Callide C4 on 25 May 2021 resulted in the tripping of over 3,000 MW of generation, and the separation of Queensland from the rest of the mainland NEM¹⁵⁴.

There are also multiple generator fast tripping schemes across the mainland NEM that result in the loss of significant levels of IBR generation for different contingencies. The Generator Fast Trip (GFT) scheme in North-West Victoria has a total generation capacity that could reach approximately 800 MW if not limited by constraints. In addition, for the loss of the double-circuit 500 kV lines into Moorabool, there is the South-West Victoria GFT scheme that trips Stockyard Hill and Dundonnell wind farms, which could result in the loss of up to 850 MW of generation. The committed Golden Plains Wind Farm Stage 1 has a capacity of 730 MW and is connecting at the 500 kV Cressy Terminal Station. If this generator is also added to the South-West Victoria GFT scheme, the operation of the scheme could result in a contingency size greater than 1,500 MW. Ryan Corner Wind Farm, with a capacity of 218 MW, and Hawkesdale Wind Farm, with a capacity of 96 MW, are committed generators that are also going to be added to the GFT scheme. To address this, AVP has advised it is investigating/planning modifications to the triggering conditions of this scheme to minimise the impact on generators¹⁵⁵.

There are several large future 2024 ISP actionable double-circuit augmentations and REZ developments across the NEM, such as HumeLink (which was studied as a priority risk for this GPSRR), VNI West, Central West Orana REZ, New England REZ and Western Renewables Link – refer to Appendix A4.2. The non-credible loss of any of these future augmentations could have significant cascading impacts on the power system if suitable controls are

¹⁵² See https://aemo.com.au/-/media/files/stakeholder_consultation/consultations/nem-consultations/2023/draft-2023-general-power-system-risk-review/2023-gpsrr.pdf?la=en.

¹⁵³ An N-2 contingency refers to planning for a simultaneous loss of 2 transmission elements. AEMO operates the system to be secure for the loss of any single transmission element, which are (N-1) contingencies.

¹⁵⁴ See https://aemo.com.au/-/media/files/electricity/nem/market_notices_and_events/power_system_incident_reports/2021/final-report-trip-of-multiple-generators-and-lines-in-qld-and-under-frequency-load-shedding.pdf?la=en.

¹⁵⁵ See https://aemo.com.au/-/media/files/electricity/nem/planning_and_forecasting/vapr/2023/2023-victorian-annual-planning-report.pdf?la=en.

not implemented. Furthermore, in recent years there have been multiple tower failures across the NEM, indicating that the risk of losing a double-circuit transmission line is not remote:

- Loss of Moorabool – Sydenham 500 kV lines on 13 February 2024.
- Trip of South East – Taillem Bend 275 kV lines on 12 November 2022.
- Trip of Liapootah – Palmerston – Waddamana 220 kV lines on 14 October 2022.

In the Tasmanian power system, under the *Electricity Supply Industry (Network Planning Requirements) Regulations 2018*¹⁵⁶, there is a requirement that no more than 850 MW of load is capable of being interrupted by a single asset failure, and that the load that is interrupted by a single asset failure is not to be capable of resulting in a black system. A single asset failure is defined as a single incident other than a credible contingency that results in the failure of one single asset, such as one double-circuit transmission line circuit that contains two three-phase circuits or one substation busbar. In the planning of the Tasmanian power system, this requirement effectively limits the maximum (N-2) non-credible contingency size.

However, the enablement of cost-effective transmission across the mainland NEM is critical to maintain system reliability whilst enabling the energy transmission. The recent review of the FOS recommended against introducing a maximum credible generation contingency limit for the mainland NEM¹⁵⁷. Therefore, it is unlikely that limiting the maximum (N-2) non-credible contingency size in the mainland NEM would be feasible.

Under S.5.1.8, NSPs must consider non-credible contingency events which potentially endanger the stability of the power system, and in consultation with AEMO install and maintain appropriate emergency controls to minimise potential disruptions and/or the probability of cascading failures. Given the numerous future actionable augmentations across the NEM, the implementation of RASs to remediate the risk of cascading failures for non-credible contingency events will become increasingly critical to enable the required transmission/network capacity whilst managing power system risks. However, this growth in the number of RASs will increase power system operational complexity and increase the risk of maloperation or unintended interactions between schemes – refer to Section 6.6.

To address this, the 2023 GPSRR included a recommendation for NSPs, in line with the requirements of NER S5.1.8, to continue to consider non-credible contingency events which could adversely impact the stability of the power system. In considering these non-credible contingency events, NSPs should identify and implement suitable controls to mitigate any identified risks. It is anticipated that these controls may involve the implementation of new remedial action schemes, in which case NSPs should consult with AEMO and refer to the RAS Guidelines developed by AEMO and NSPs¹⁵⁸. Additionally, if an effective RAS cannot be practically implemented or the operation of a RAS could cause cascading failures, NSPs should investigate alternative remedial measures, including the installation of additional assets, changing of operational arrangements or integration of storage at the location of the contingency, thereby reducing the effective maximum contingency size.

Operationally, the impact of non-credible contingencies during abnormal conditions, such as severe weather, can be minimised through reclassification and the invoking of the associated constraints by AEMO in accordance with

¹⁵⁶ See <https://www.legislation.tas.gov.au/view/html/inforce/current/sr-2018-002#GS5@EN>.

¹⁵⁷ See <https://www.aemc.gov.au/sites/default/files/2023-04/REL0084%20-%20Final%20Determination.pdf>.

¹⁵⁸ See <https://aemo.com.au/energy-systems/electricity/national-electricity-market-nem/system-operations/remedial-action-scheme-guidelines>.

the SO_OP_3715 reclassification criteria, which could involve the procurement of additional FCAS¹⁵⁹. It is important to note the broadening of the scope of the reclassification criteria following the indistinct events rule change in 2022¹⁶⁰.

6.14.2 Localised aggregated BESS response to remote frequency disturbances

Large-scale BESS have the potential to provide significant frequency raise services in response to system frequency disturbances. Many existing large-scale BESS installations in the NEM have aggressive frequency droop settings (< 2%), meaning that they discharge/charge at high rates for small frequency disturbances. As discussed in Section 5.3, if suitable headroom is available, large-scale BESS can assist with arresting system frequency for large generation or load contingency events, thereby reducing the reliance on regional UFLS or OFGS schemes. However, as noted in Section 5.3, the location of large-scale BESS greatly impacts power system stability, as fast discharging/charging in response to remote frequency disturbances could cause large active power swings on interconnectors.

In particular, South Australia has significantly greater large-scale BESS capacity installed (including the new 250 MW Torrens Island BESS) compared to the rest of the mainland NEM, as shown in Table 32. This means there is an increasing risk that the aggregate response of the BESS in South Australia to a remote generation contingency for South Australia export conditions, and to a remote load contingency for South Australia import conditions, could result in large swings on the Heywood interconnector prior to the commissioning of PEC Stage 2. For South Australia import conditions, the newly commissioned WAPS scheme is designed to prevent South Australia islanding following large generation contingencies within South Australia¹⁶¹ (noting that WAPS is not designed to operate for remote load contingencies).

Table 32 Current NEM regional Installed large-scale BESS capacity (including plants undergoing commissioning)¹⁶²

Incident date	Aggregated installed BESS capacity (MW)
South Australia	500
Queensland	250
Victoria	545
New South Wales	210

Depending on the response of the SIPS out-of-step relay¹⁶³, such power swings could result in the tripping of the Heywood interconnector, and the islanding of South Australia. For South Australia export conditions, the resultant

¹⁵⁹ See https://www.aemo.com.au/-/media/Files/Electricity/NEM/Security_and_Reliability/Power_System_Ops/Procedures/SO_OP_3715%20Power-System-Security-Guidelines.pdf.

¹⁶⁰ See <https://www.aemc.gov.au/rule-changes/enhancing-operational-resilience-relation-indistinct-events>.

¹⁶¹ See https://aemo.com.au/-/media/files/stakeholder_consultation/consultations/nem-consultations/2022/psfrr/2022-final-report--power-system-frequency-risk-review.pdf?la=en.

¹⁶² See <https://aemo.com.au/en/energy-systems/electricity/national-electricity-market-nem/nem-forecasting-and-planning/forecasting-and-planning-data/generation-information>.

¹⁶³ When two areas of a power system or two interconnected systems lose synchronism, the synchronous areas should be separated to avoid equipment damage or a system-wide shutdown. Out-of-step protection functions detect stable power swings and out-of-step conditions by using the fact that the voltage/current variation during a power swing is gradual while it is a step-change during a fault.

over frequency in South Australia would likely trigger operation of the OFGS scheme. For South Australia import conditions, UFLS would likely operate to arrest the frequency decline.

Initial/preliminary high-level studies completed by AEMO suggest that South Australia export conditions are most onerous, as the possible remote generation contingency size is larger than the South Australia load contingency size (for South Australia import conditions). For South Australia import conditions, the largest contingency likely involves the non-credible loss of QNI for Queensland import conditions over 900 MW. As detailed in Section 4.2, the satisfactory stability limit of the Heywood interconnector for South Australia import conditions is approximately 850 MW. Therefore, it is expected that any aggregated BESS response for a remote load contingency that results in the Heywood interconnector flow exceeding this threshold could result in instability and the separation of South Australia. For South Australia export conditions, the initial studies by AEMO indicate that the Heywood interconnector remains stable for single credible generation contingencies for flows up to 650 MW, but could become unstable for more severe/significant remote non-credible generation contingencies. However, as additional large-scale BESS are installed in South Australia, this may change depending on what BESS are installed in other mainland NEM regions.

As part of this GPSRR, additional sensitivity studies were completed tripping the Loy Yang A and Millmerran units outside South Australia for South Australia export conditions. Large swings on the Heywood interconnector were observed, with the Heywood flow reaching 960 MW within 5 seconds (from a pre-contingent flow of 640 MW) and there was voltage collapse around South East, which resulted in South Australia losing synchronism with the rest of the NEM. Therefore, further studies need to be completed including modelling of the SIPS out-of-step relay to understand if South Australia would separate/island for these types of power swings.

During the recent 13 February 2024 Victoria power system event involving the loss of the Loy Yang A generating units (see Section 3.2.3), the initial swing on the Heywood interconnector towards Victoria that was observed was approximately 200 MW¹⁶⁴. It is important to note that the Torrens Island BESS was not online during this event as it was still undergoing commissioning, so there was significantly less total BESS headroom available in South Australia.

To mitigate the risks posed by fast BESS charging/discharging to remote frequency disturbances causing instability on regional interconnectors, AEMO and ElectraNet are currently investigating the following options:

- Completion of further studies investigating how much installed BESS capacity in South Australia would cause instability on the Heywood interconnector for remote credible frequency contingencies.
- Implementation of less aggressive frequency droops in future BESS.
- AEMO may work with OEMs to investigate the possibility of implementing two droop settings for new BESS connections – an aggressive droop setting for large frequency deviations and a more conservative droop setting for small frequency deviations.
- An enhanced WAPS for South Australia export conditions to detect unstable power swings and the integration of new BESS into the WAPS system. In the long term, the SAIT RAS scheme will be designed to incorporate new BESS into the scheme to address this issue.

¹⁶⁴ See https://aemo.com.au/-/media/files/electricity/nem/market_notices_and_events/power_system_incident_reports/2024/preliminary-report--loss-of-moorabool---sydenham-500-kv-lines-on-13-feb-2024.pdf?la=en.

Recommendation 11

At the time of finalising this draft report, AEMO is working with ElectraNet to consider suitable remedial measures to address this risk.

6.14.3 System restart with the transitioning power system

System restart ancillary services (SRAS) contribute to the overall resilience of the power system by enabling recovery following a major blackout. SRAS is a service provided by generators with the ability to start, or remain online, without drawing electricity from the grid. SRAS providers “restart” the power system by providing energy to other generators following a major blackout, which in turn restores supply to consumers.

SRAS has historically been provided by large synchronous generating units, since these units can output active power consistently and provide inertia to maintain stability. Due to the current reliance on large thermal units to provide SRAS services, the limited pool of existing system restoration units is decreasing with generation retirements. As such, the ongoing changes in the generation mix and the physics of the power system because of the energy transition mean that there are a number of emerging challenges which will make it harder to prepare for major blackouts and to restore the power system if such an event occurs:

- There is a limited pool of SRAS providers in some NEM regions, and some are potentially less capable of effectively commencing the process of restoring the power system. Overall, there is currently little competition for the provision of SRAS services, and limited incentives for the development/construction of new restart capable plants.
- New transmission-level generator connections are nearly all IBR, so few are capable of energising themselves and therefore providing SRAS. Additionally, there is currently no incentive for BESS to guarantee headroom to provide SRAS. A lack of system strength during restart also prevents grid-following BESS participating in the early stages of restoration.
- Another growing risk for system restart is the effects of DPV generation. Sufficient stabilising demand is required for system restart, but higher DPV generation operating conditions are causing load variations and load erosion. The existing DPV management processes may be too cumbersome and/or ineffective to use in restart scenarios. Therefore, it is possible that there may be insufficient stable demand to restart the system until night-time/low DPV operating conditions.

The system restart path across NEM regions is moving with the changing generation mix and restart sources are often a long distance from major load centres. Therefore, although system restart path testing is valuable, it has a significant market impact and there are limited testing opportunities. Overall, actual restart timelines are not likely to enable the energising of sensitive loads in the required timeframe to meet the system restart standard¹⁶⁵.

To address some of the emerging risks associated with system restart, AEMO is currently:

- Working to revise regional system restart plans to ensure minimum switching is required.
- Conducting annual system restart training with NSPs.

¹⁶⁵ See https://www.aemc.gov.au/sites/default/files/2022-06/REL0077%20SRS%20Review%20-%20System%20Restart%20Standard%20-%20FOR%20PUBLICATION_0.pdf.

- Seeking improved and accurate information from generators and NSPs to input into restart plans.
- Working to encourage and enable extended network testing.
- Changing processes to improve system resilience.
- Investigating/exploring the use of grid-forming inverters and/or the possibility of utilising BESS during early stages of system restoration.

AEMO also recommends DNSPs implement ‘emergency back-stop’ mechanisms to facilitate the availability of stable demand/load blocks during system restart. Following the trip of the South East – Taillem Bend 275 kV lines on 12 November 2022 due to tower failure, AEMO recommended emergency curtailment backstop capabilities be implemented in all regions (ability to curtail all new DPV installations to zero active power if required as a last resort to maintain power system security) as a priority (refer to Table 2 in Appendix A2).

AEMO also recommends a review of the system restart standard (set by the Reliability Panel) to ensure it reflects the actual capability of the power system. Possible incentivisation options for the construction of restart capable plants and the facilitation of extended network testing should also be investigated along with the need for any system restart support services.

6.14.4 Management of generation retirement

Approximately 20% (6,730 MW) of the currently registered coal, gas, and diesel generation fleet is expected to retire in the next 10 years¹⁶⁶. Furthermore, almost all the coal generators owners have currently announced their long-term retirement plans with the potential to retire early, given that the required time for notice of closure is only three and half years. Such short retirement notices allow little time to respond to the increased security and reliability risks caused by early generator retirements. As detailed in Section 6.4.4, the retirement of synchronous power plants also impacts overall regional system strength.

Additionally, as existing coal units retire, the typical regional dispatch patterns change, which may impact the likelihood and/or consequence of certain non-credible contingencies. Recognising the significant impact of coal generation retirement in New South Wales, the 2023 GPSRR recommended Transgrid share with AEMO its investigation findings on the risk and consequence of non-credible contingencies on the 330 kV lines supplying Sydney, Newcastle and Wollongong following potential Eraring Power Station closure, for consideration in future GPSRRs.

The recently published 2023 *Victorian Annual Planning Report* (VAPR)¹⁶⁷ also identified several risks posed by significant thermal generator retirement in Victoria:

- The significant reduction in the availability of system security services traditionally supplied by thermal generation.
- The overutilisation of the western part of the Victorian network past its design capabilities, and the resultant need to constrain renewable generation, following the retirement of thermal generation located in the eastern part of the network.

¹⁶⁶ AEMO (August 2023) 2023 ESOO, https://aemo.com.au/-/media/files/electricity/nem/planning_and_forecasting/nem_esoo/2023/2023-electricity-statement-of-opportunities.pdf?la=en&hash=D8CC2D9AC8D9F353194C9DD117095FB4.

¹⁶⁷ At https://aemo.com.au/-/media/files/electricity/nem/planning_and_forecasting/vapr/2023/2023-victorian-annual-planning-report.pdf?la=en.

In addition, shortfalls have been identified in system strength around Metropolitan Melbourne and the Latrobe Valley due to factors such as the forecast retirement of Yallourn Power station, rapid uptake of CER and declining minimum operational demand.

The orderly management of generator retirements is crucial to minimise the associated operational risks and ensure that the security and reliability of the power system is maintained. The 2024 Draft ISP¹⁶⁸ highlighted that the risks associated with generator retirements are best mitigated through agreed closure timeframes and delivery of the planned investment in generation capacity. Additionally, it is imperative to investigate and implement alternative options to replace the security services traditionally provided by the thermal generators, such as system strength, prior to their retirement.

Given the rapid changes in the power system, AEMO recommends that NSPs prioritise forward-looking studies in accordance with NER S5.1.8 to investigate the impact of all generation retirements expected in the next five years on power system constraints and the risk and consequence of non-credible and multiple contingencies in their network and share the findings with AEMO for consideration in future GPSRRs. As part of this, NSPs should explicitly specify and rate the risks associated with anticipated generation retirements as part of the GPSRR risk assessment process.

6.14.5 Management of non-credible risks when operating at 100% renewables

Over the coming years, there are forecast to be times when the NEM has enough renewable energy resource potential¹⁶⁹ to meet 100% of its instantaneous demand. As shown in Figure 14, NEM renewable potential has already reached a maximum of 99.7% in Q4 of 2023 (in comparison, the maximum penetration of renewable energy generation reached in the NEM was 72.1% in Q4 of 2023)¹⁷⁰. These periods will initially emerge at times of low operational demand, although continued investment will see them cover an increasing range of system conditions. This will create new needs for system security services, and the most efficient outcomes will require investments that can meet multiple needs at once.

¹⁶⁸ See https://aemo.com.au/-/media/files/stakeholder_consultation/consultations/nem-consultations/2023/draft-2024-isp-consultation/draft-2024-isp.pdf?la=en.

¹⁶⁹ Renewable potential refers to the total available energy from renewable generators at an instant in time given the weather conditions at that time, regardless of whether those generators ultimately provide all that electricity into the NEM. Renewable penetration refers to the proportion of NEM generation sourced from renewables at a given instant in time. This can be less than the corresponding renewable potential at that time.

¹⁷⁰ See <https://aemo.com.au/-/media/files/major-publications/qed/2024/qed-q1-2024.pdf?la=en&hash=CDAE3D2A5BA31DD3BF03A1EA39840F34>.

Figure 14 NEM renewable energy generation potential and penetration up until Q1 2024

Percentage of NEM supply from renewable energy sources at time of peak instantaneous renewable energy output

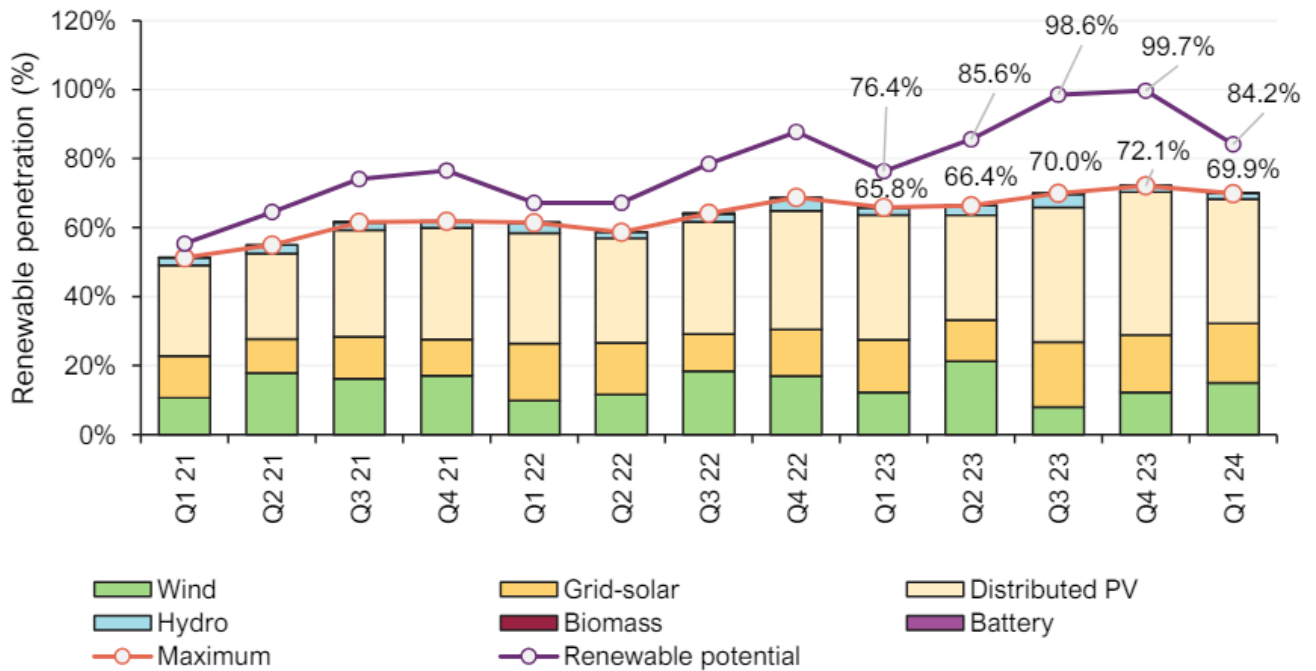

Readiness for 100% instantaneous renewables¹⁷¹ is a critical enabler for being able to operate the power system regularly with high penetrations of renewables, in turn supporting the transition to a net zero energy system. A concerted industry effort is needed to deliver the NEM’s transition, and efforts are progressing on many fronts. For AEMO, many of these efforts relate to engineering and operational readiness activities.

The *Engineering Roadmap to 100% Renewables*¹⁷² (the Roadmap) focuses primarily on addressing what, from an engineering perspective, must be done to securely and reliably run a power system at times without fossil fuels. While the intent is to be ready for the first 100% instantaneous renewables period (which could include any renewable generation sources), the predominant challenge will involve managing high penetrations of variable IBR like wind and solar generation, which make up the majority of new renewables coming into the NEM. The *Engineering Roadmap FY2024 priority action report*¹⁷³ provides an overview of the actions that AEMO will undertake in the 2023-24 financial year (FY2024) to progress readiness efforts for the first periods of 100% instantaneous renewables in the NEM.

Additionally, the 2022 and 2023 AEMO NSCAS reports¹⁷⁴ contain details of initial studies completed by AEMO for system strength, inertia and voltage control of the mainland NEM during periods of high instantaneous IBR penetration. Latest analysis by AEMO in studying the outcomes of credible contingencies confirms that¹⁷⁵:

¹⁷¹ 100% instantaneous penetration of renewables refers to a half-hour period in which all demand is met from renewable sources, including grid-scale wind and solar, hydro generation, biomass, storage, and rooftop PV.

¹⁷² At <https://aemo.com.au/-/media/files/initiatives/engineering-framework/2022/engineering-roadmap-to-100-per-cent-renewables.pdf?la=en>.

¹⁷³ See <https://aemo.com.au/-/media/files/initiatives/engineering-framework/2023/nem-engineering-roadmap-fy2024--priority-actions.pdf?la=en>.

¹⁷⁴ See <https://aemo.com.au/energy-systems/electricity/national-electricity-market-nem/nem-forecasting-and-planning/system-security-planning>.

¹⁷⁵ See https://aemo.com.au/-/media/files/electricity/nem/security_and_reliability/system-strength-requirements/2023-nscas-report.pdf?la=en.

- The most onerous requirements are likely to be those for system strength, which may require provision of system strength equivalent to more than 45 x 125 MVA synchronous condensers. Of this, approximately 50% is needed to meet minimum fault level requirements and must be met by devices that provide fault current – such as new synchronous condensers, service contracts with existing hydro or thermal units, or by the retrofit of those existing units themselves. The remaining 50% is necessary to accommodate future IBR and could be met by a variety of new technologies, including grid-forming inverters.
- Inertia needs can be met alongside system strength, provided that the benefits of inertia services are considered in conjunction with the procurement of system strength services.
- Voltage control needs are supported by the additional reactive capabilities provided by IBR investment, particularly when IBR is installed in sufficient volumes to meet maximum demand conditions.

The GPSRR plays an integral role in the readiness of the NEM for 100% instantaneous renewables by assessing current and future risks associated with events and conditions that could cause cascading failures or supply disruptions and evaluate mitigation options. This includes assessing risks associated with future (five-year-ahead) network augmentations and operating conditions with higher levels of instantaneous renewable generation.

As the NEM moves closer to operating with 100% instantaneous renewables, it will become increasingly important for AEMO to consider the impact of non-credible contingencies during times of high levels of renewable generation. Therefore, for future GPSRRs, AEMO will include 100% renewable generation sensitivities for the critical non-credible contingencies assessed.

100% Inverter Based Resource Generation Study – Tasmania Region

The installed capacity of IBR in Tasmania coupled with Basslink is sufficient to meet the island's demand for some dispatch periods, so the region is suitable for exploring the possibilities and challenges of 100% IBR operation. In 2023, AEMO and TasNetworks completed a scoping study which addresses an *Engineering Roadmap* priority for FY2024 to clarify the system requirements to support operation of the Tasmanian network with up to 100% IBR generation¹⁷⁶.

The study demonstrated that, with the addition of a modestly sized grid-forming BESS and additional wind generation, the Tasmanian power system of mid-2023 would be capable of 100% IBR operation at low system demands with high levels of reliance on the synchronous condenser capabilities of the Hydro Tasmania fleet. It was determined that more inertia would be required to extend this operation beyond low system demands. The study did not explore the benefits of inertial response from IBR – it is expected that this would bring some benefit depending on the location of critical contingencies and the inertial source(s).

The study used a grid-forming BESS to provide many of the supports required to enable 100% IBR, including contingency and regulation FCAS and primary frequency response (PFR). The study showed that:

- The effectiveness of this BESS can be undermined through inaccurate tripping associated with the Basslink frequency control system protection scheme (FCSPS) as an example.
- 100% IBR cannot be maintained without proper consideration for the contingency response and the regulation demand and ensuring that there is sufficient capacity for both.

¹⁷⁶ See <https://aemo.com.au/-/media/files/initiatives/engineering-framework/2023/tasmania-100-percent-ibr-generation-study.pdf?la=en>.

Even though credible contingencies can be managed using current methods that ensure adequate ancillary services, operation at 100% IBR may lead to a less viable system following non-credible contingencies. The viability of the system or islands that form due to non-credible contingencies is important, because the overall resilience and reliability of the power system may be adversely affected without proper consideration of either ride-through or system recovery and/or restart. Future GPSRRs will therefore play an important role in highlighting and assessing contingency events that could cause cascading failures or supply disruptions under different operating conditions, including 100% IBR operation, and evaluating different mitigation options.

6.14.6 Transition Planning

Transition Planning is one of many broader AEMO initiatives aimed at supporting the energy transition. Transition planning investigates the feasible technical operating envelope into the future and enables the secure and efficient operation of the NEM with higher penetrations of renewable energy generation. There are three broad areas that will be considered as part of the transition planning work:

- Progressing the next immediate operational transitions¹⁷⁷ over a 12-to-18-month time horizon and ensuring readiness for these transitions. This will require close collaboration with the relevant NSPs in support of defining and managing any planned operational transition.
- Investigating the upcoming operational transition points over the next 18 months to 5 years and carrying out suitable studies to assess emerging system needs and the identification of any regional challenges, requirements and enablers.
- Identifying any new or emerging power system requirements in the 5 year + timeframe that are required to support the transition, including planning any future research focus areas and leveraging research underway.

As detailed in Appendix A3.1, a recent rule change introduced a new annual reporting requirement on AEMO, known as the ‘transition plan for system security’ (or transition plan)¹⁷⁸. AEMO will publish the first of these reports by 1 December 2024. The transition plan will consider the broad areas outlined above and will include an overview of this in the transition plan. The support of both the TNSPs and the DNSPs will be a key part of developing a robust transition plan.

This work builds on the substantial work already in progress by AEMO and the NSPs to support the energy transition across Australia. The key relevant initiatives include:

- AEMO’s *Engineering Roadmap to 100% Renewables*.
- Annual reporting by AEMO on the steps it will take to manage security through the transition. As detailed in Appendix A3.1, a recent rule change introduced a new annual reporting requirement on AEMO, known as the ‘transition plan for system security’ (or transition plan). AEMO will publish the first of these reports by 1 December 2024.

¹⁷⁷ Operational Transition Points are essentially the expansion of the technical operating envelope of the NEM via staged implementation of new limits (Operational Transitions). This is designed to successively commission the system to new operating points as we transition toward 100% instantaneous penetrations of renewables.

¹⁷⁸ See <https://www.aemc.gov.au/rule-changes/improving-security-frameworks-energy-transition>.

- Program of work underway to operate South Australia with fewer synchronous generating units online under certain operating conditions, as detailed in Section 2.1.1.
- Initiatives by AEMO to manage system security and system strength detailed in Section 6.4.4.
- The Operations Technology Program, which was initiated to uplift AEMO's control room technical capability in line with the rules and regulations¹⁷⁹.
- AEMO's involvement with the Global Power System Transformation Consortium (G-PST)¹⁸⁰.

Details of the Operational Transition Planning process and associated Operational Transition Points will be published in AEMO's Transition Plan for System Security to be published by December 2024.

AEMO has established an Operational Transition Program Working Group under the National Electricity Market Operations Committee (NEMOC) with the purpose of:

- Identifying the Operational Transition Points under the control or influence of AEMO and the TNSPs.
- Understanding the range of studies/analysis/trials required to be carried out to inform Operational Transition Points.
- Reviewing the Transition Plan for System Security in the context of emerging power system operational issues that limit utilisation of the transmission network capacity and renewable portfolio.
- Considering governance in the context of significant Operational Transition Points.
- Assessing operational preparedness in advance of new operational transition points/system transitions.

6.14.7 Auto-bidding systems risk

A growing number of NEM participant generators are utilising 'auto-bidding' software, which carries out bids and rebids automatically in accordance with pre-set parameters. Auto-bidding tools typically use five-minute pre-dispatch and dispatch data for decision-making. This reliance on five-minute pre-dispatch data means that auto-rebidding typically takes place less than one hour ahead of dispatch.

As such, a growing proportion of generation utilising auto-bidding software means there is less certainty around dispatch and reserves. If large volumes of re-bidding occur during times of high demands or low reserves, this lack of certainty could have a large impact on system reliability and security, including on the need to direct additional generation, activate RERT or load shed. AEMO will conduct further analysis to understand this emerging risk as part of future risk reviews.

Additionally, there are few providers of auto-bidding software, meaning that there is a risk of the operation of a significant proportion of NEM generation being impacted by a software fault/bug or cyber incident impacting a single provider. Generally, good cyber security practices and suitable system redundancy (see Section 6.13) should be implemented to ensure the operation of generation is not halted due to the unavailability of auto-bidding software.

¹⁷⁹ See <https://aemo.com.au/en/initiatives/major-programs/operations-technology-program>.

¹⁸⁰ See <https://globalpst.org/>.

Lastly, an associated risk which has already become evident in the NEM is the volume of data associated with auto-rebidding, as well as self-forecasting. The increasing volume of rebidding data has resulted in instances of very large file sizes, in particular for the five-minute dispatch files which are published every five minutes. This can impact the ability of AEMO to achieve timely publication of market reports if the suitable IT infrastructure is not in place. AEMO is currently working to ensure that the increasing volume of re-bidding data can be effectively managed into the future, enabling the timely publication of market reports.

6.14.8 Generator compliance

AEMO has identified that generator non-compliances have steadily risen in number over the last decade, commensurate with the growing number of new generator connections and in turn the total number of operational plants. AEMO is reviewing improvements to processes to identify efficiencies for all affected parties to improve the efficiency of non-compliance management and rectification.

This trend in the number of generator non-compliances has the potential to result in a cumulative impact on system operations and security. A number of factors could be driving this:

- The increased number of connections.
- Increased reporting of compliance issues.
- Increased observation of non-compliances due to system events.
- Inadequate change management processes.
- Inadequate assessment and/or onerous technical requirements leading to a greater likelihood that performance does not meet the defined performance standards.
- As highlighted in recent power system events, generator compliance has the potential to exacerbate the impact of power system events. Generator compliance has previously been considered by AEMO in the WEM through Generator Monitoring Plans¹⁸¹, designed to ensure compliance is maintained at regular intervals. AEMO has noted generator non-compliance as an emerging risk and will further consider this in the 2025 GPSRR.

¹⁸¹ See <https://aemo.com.au/en/energy-systems/electricity/wholesale-electricity-market-wem/system-operations/generator-monitoring-plans>.

7 Protected events

7.1 Existing protected event

Under NER 5.20A.1(c), a GPSRR is required to assess the following matters for existing protected events:

- Adequacy and costs of the arrangements for management of an event.
- Whether to recommend a request to revoke the declaration of an event as a protected event.
- Where a revocation request is not recommended, the need to change the arrangements for management of an event.

There was previously only one protected event declared by the Reliability Panel:

"The loss of multiple transmission elements causing generation disconnection in the South Australia region during periods where destructive wind conditions are forecast by the Bureau of Meteorology"¹⁸².

This protected event was managed as follows:

- AEMO imposed a 250 MW South Australia import limit on the Heywood Interconnector during forecast destructive wind conditions in South Australia.
- An EFCS called the WAPS¹⁸³ is also in place in South Australia to lower the risk of islanding due to trip of up to 500 MW of South Australian generation while South Australia is importing power.

The 2022 PSFRR recommended AEMO investigate whether the South Australian destructive wind protected event could be managed under updated contingency reclassification criteria¹⁸⁴, and if so to recommend revocation of the protected event. AEMO's subsequent investigation, which included consultation with ElectraNet and the AEMC, concluded that the protected event could be effectively managed under the contingency reclassification framework and NER S5.1.8. Therefore, on 11 April 2023 AEMO submitted a request to the Reliability Panel to revoke the protected event prior to 1 October 2023¹⁸⁵.

On 14 September 2023, the Reliability Panel published a final determination to revoke the South Australian destructive winds protected event¹⁸⁶. The protected event was revoked from 30 March 2024, prior to the connection of Project EnergyConnect Stage 1 with the grid, expected in 2024.

AEMO expects no change in operational outcomes from managing destructive winds in South Australia following the protected event being revoked. The existing 250 MW South Australia import limit on the Heywood interconnector during forecast destructive winds in South Australia will be effectively managed under the

¹⁸² Reliability Panel AEMC, Final Report AEMO Request for a Protected Event Declaration, 20 June 2019, p22, <https://www.aemc.gov.au/sites/default/files/2019-06/Final%20determination%20-%20AEMO%20request%20for%20declaration%20of%20protected%20event.pdf>.

¹⁸³ The WAPS is an upgrade of the previous System Integrity Protection Scheme (SIPS).

¹⁸⁴ Updated reclassification criteria were implemented on 9 March 2023, the effective date of the National Electricity Amendment (Enhancing operational resilience in relation to indistinct events) Rule: <https://www.aemc.gov.au/rule-changes/enhancing-operational-resilience-relation-indistinct-events>.

¹⁸⁵ This is prior to the expected date of synchronous electrical connection of South Australia to New South Wales via PEC Stage 1.

¹⁸⁶ See <https://www.aemc.gov.au/market-reviews-advice/revoking-south-australian-protected-event#:~:text=The%20South%20Australian%20protected%20event%20was%20declared%20by%20the%20Reliability,Australia%20on%2028%20September%202016.>

SO_OP_3715 reclassification criteria¹⁸⁷. It is important to note the broadening of the scope of the reclassification criteria following the indistinct events rule change in 2022¹⁸⁸. In addition, the WAPS EFCS will continue to be managed in accordance with NER S5.1.8.

The existing reporting obligations set out in the NER in relation to contingency reclassification and the GPSRR will provide transparency to market participants and industry stakeholders in relation to the operational arrangements put in place by AEMO to manage the risk of destructive winds, including the appropriateness of these controls and how they might change to reflect future changes in the power system. AEMO will continue to review and report on the effectiveness and appropriateness of the arrangements to manage the risk of destructive winds in South Australia as part of its annual GPSRR.

Additionally, following the revocation of the protected event, the existing reclassification framework requires AEMO to report on the reasons for any reclassification decisions and the appropriateness of the related mitigation measures every six months¹⁸⁹.

Since the 2023 GPSRR, the South Australia 250 MW import constraint¹⁹⁰ has been invoked three times on 7 July 2023, 2 October 2023 and 8 December 2023 due to destructive wind conditions in South Australia utilising the reclassification framework¹⁹¹.

7.2 Post PEC Stage 1

The commissioning of PEC Stage 1 later in 2024 will create a second AC flow path to South Australia (see Figure 5). This will change the response of the South Australia network to the loss of multiple transmission elements causing generation to disconnect in South Australia and should therefore be considered in the assessment of future management of the risk of destructive winds in South Australia.

Previously, ElectraNet studied whether South Australia will still be at risk of islanding following the trip of 500 MW generation post-PEC Stage 1. Preliminary studies indicated that losing 500 MW of generation during maximum import could lead to issues including thermal overload of PEC Stage 1 plant¹⁹². This could lead to a trip of PEC Stage 1, and a cascading trip of the Heywood interconnector, islanding South Australia and leading to a black system.

ElectraNet is in the process of designing modifications to WAPS to be applied post-PEC Stage 1 to mitigate these risks and minimise their economic impact. The modified WAPS will aim to prevent South Australia islanding following a trip of 500 MW of generation, even at maximum South Australian import (approximately 600 MW on Heywood and 100 MW on PEC Stage 1). However, due to the significant consequences of islanding, AEMO

¹⁸⁷ See https://www.aemo.com.au/-/media/Files/Electricity/NEM/Security_and_Reliability/Power_System_Ops/Procedures/SO_OP_3715%20Power-System-Security-Guidelines.pdf.

¹⁸⁸ See <https://www.aemc.gov.au/rule-changes/enhancing-operational-resilience-relation-indistinct-events>.

¹⁸⁹ See <https://aemo.com.au/en/energy-systems/electricity/national-electricity-market-nem/nem-events-and-reports/power-system-reclassification-events>.

¹⁹⁰ The VS_250 market constraint imposes an upper transfer limit of 250 MW from Victoria to South Australia on Heywood and is invoked as part of the existing South Australia destructive winds protected event.

¹⁹¹ See <https://aemo.com.au/en/energy-systems/electricity/national-electricity-market-nem/nem-events-and-reports/power-system-reclassification-events>.

¹⁹² Based on 15-minute thermal rating of the Buronga PST.

considers it prudent to constrain South Australia imports during forecast destructive wind conditions, rather than rely on the modified WAPS alone.

Given these changes to network conditions, the existing 250 MW constraint on Heywood that is applied during South Australia destructive wind conditions to reduce the likelihood of South Australia islanding was reviewed to determine if it will remain appropriate post-PEC Stage 1 – see Section 5.4.

The limits defined here in the 2024 GPSRR apply for destructive wind conditions that could result in the loss of multiple transmission elements causing generation disconnection in South Australia to reduce the likelihood of South Australia islanding. This is separate to the South Australia import constraints that are invoked for destructive wind conditions impacting Heywood where South Australia islanding is reclassified as credible. As PEC Stage 1 will be inter-tripped with Heywood, the South Australia destructive wind transfer import limit for the credible loss of Heywood will remain at 250 MW.

Through studies completed in the 2024 GPSRR, AEMO has determined that after the commissioning and interconnector testing of PEC Stage 1 is completed destructive wind transfer limits into South Australia of 350 MW for Heywood and 50 MW for PEC Stage 1 will mitigate the risk of exceeding the satisfactory South Australia interconnector limits for a nominal 600 MW South Australia generation contingency size. These limits also allow for up to 100 MW of interconnector drift.

AEMO has identified that DPV generation shake-off in response to power system faults can further increase the total South Australia contingency size. To account for this impact, AEMO will dynamically reduce the stated maximum destructive wind transfer limits by 10% of the online South Australia DPV generation. Refer to Section 5.4 for more information on this recommendation.

Note that the limits stated above assume system normal conditions and the full capacity of Heywood and PEC Stage 1. If there are significant system outages or other constraints that limit the effective capacity of Heywood or PEC Stage 1, the destructive wind transfer limits will be reduced accordingly. If PEC Stage 1 is out of service or constrained to 0 MW, the existing 250 MW interconnector limit into South Australia will apply.

The previous South Australia destructive winds protected event required AEMO to take steps to actively manage the risk that, during periods of forecast destructive wind conditions in South Australia, the loss of multiple transmission elements could cause up to 500 MW of generation to disconnect in South Australia (being a contingency that is assumed to be reasonably possible when destructive winds are forecast). Since 2019, the system dispatch and operating conditions in South Australia have changed due to several different factors, which impact the appropriate nominal contingency size considered in determining the destructive wind limits. As discussed further in Section 4.2.4, AEMO has determined as part of its analysis that an increased nominal contingency size of 600 MW should be used to calculate the destructive wind limits. The nominal contingency size used to calculate the destructive wind limits will be reviewed following any major changes in the South Australia system or operational conditions.

Consistent with the Reliability Panel's recommendation in the final determination to revoke South Australian protected event, AEMO will publish revisions to the Interconnector Capabilities document¹⁹³, which documents the

¹⁹³ See https://www.aemo.com.au/-/media/Files/Electricity/NEM/Security_and_Reliability/Congestion-Information/2017/Interconnector-Capabilities.pdf.

nominal flow limits for each of the NEM interconnectors, to also specify the flow limits that will be applied in the event of a known priority risk, as identified through the GPSRR. This will include the flow limits that AEMO intends to apply for Heywood interconnector and PEC Stage 1 in the event of forecast destructive winds in South Australia.

7.3 Non-credible synchronous separation of South Australia from the rest of the NEM

AEMO previously identified that the deterioration of UFLS capability in South Australia increased the risk of cascading failure events following a non-credible separation of the region. Constraints were implemented under the South Australian regulations to limit imports into South Australia in periods where UFLS availability is low. The 2020 PSFRR¹⁹⁴ proposed that AEMO would explore recommending the declaration of a protected event to formalise those constraints under the NER framework and manage additional risks associated with a separation event.

AEMO's subsequent analysis has identified a suite of minor factors that contribute to the overall risk and has developed a number of low-cost measures to reduce risk to be implemented in the period prior to full commissioning of PEC Stage 2. All the recommended measures can be implemented without a protected event. Declaration of a protected event also has a number of flow-on implications, which require extensive further study and may not be economically feasible to manage at this time.

AEMO's full analysis and recommendations can be found in the report on these studies¹⁹⁵.

7.3.1 Emergency under frequency requirements for South Australia

As detailed in Section 5.3, based on the cases studied as part of the 2024 GSPRR, South Australia UFLS and large-scale BESS availability is not adequate to arrest frequency for South Australia separation followed by the loss of two stations for some South Australian import dispatch conditions. However, South Australia separation was not the focus of the 2024 GPSRR UFLS screening studies, as the South Australia EUFR requirement was assessed as part of a separate AEMO report¹⁹⁶.

This report, consistent with one of the priority recommendations from AEMO's report on separation leading to under frequency in South Australia, details the additional studies completed by AEMO to determine the total amount of EUFR needed in South Australia to adequately manage a range of significant multiple contingency events involving South Australia separation. EUFR includes the response from UFLS, as well as the frequency response from fast responding resources such as BESS and other types of IBR which can also contribute to arrest of a fast frequency decline.

¹⁹⁴ AEMO (July 2020) 2020 Power System Frequency Risk Review – Stage 1, https://aemo.com.au/-/media/files/stakeholder_consultation/consultations/nem-consultations/2020/psfrr/stage-1/psfrr-stage-1-after-consultation.pdf?la=en&hash=A57E8CA017BA90B05DDD5BB886D19CD.

¹⁹⁵ See https://aemo.com.au/-/media/files/stakeholder_consultation/consultations/nem-consultations/2022/psfrr/non-credible-separation-of-south-australia.pdf?la=en&hash=1F1702974B14DC704FB964C7A25E8645.

¹⁹⁶ AEMO (May 2024), *Emergency Under Frequency Response for South Australia*, <https://aemo.com.au/-/media/files/initiatives/der/2024/2024-05-21-emergency-underfrequency-requirements-for-south-australia.pdf?la=en&hash=200839621941320C557B67B6DC4DF59A>.

As part of this report, AEMO proposed a EUFR requirement for South Australia up until the commissioning of PEC Stage 2 that is the maximum of either 700 MW, or 60% of operational demand.

To manage the four multiple contingency events studied ~80% of the time, thereby delivering a similar risk profile to historical levels of coverage via traditional UFLS. The rollout of dynamic arming of UFLS in South Australia, and the extra battery headroom now available in South Australia, means that this target is expected to be met ~99.8% of the time, with no further actions. This delivers a similar level of residual risk to historical levels.

7.4 Protected event framework review

To address recommendation 9 from the published 2023 GPSRR final report, AEMO has completed a review of the protected event framework and considered whether a rule change submission to enhance the protected event framework is necessary. This included evaluating whether the existing protected event framework alongside the updated Power System Security Guidelines (SO_OP_3715)¹⁹⁷ allow AEMO to effectively manage existing identified power system risks.

One example that could benefit from an enhanced protected event framework is regarding schemes implemented by NSPs under NER S5.1.8 for significant non-credible contingencies. When these schemes are out of service or ineffective, there are currently no measures in place to implement constraints or otherwise reduce the risk. Therefore, with the scheme out of service, the risk reverts to the same levels it was at before the scheme was implemented. In situations like this, there may be a place for minor modifications to the protected event framework to allow for appropriate mitigating measures to be implemented.

¹⁹⁷ Which included updated reclassification criteria to reflect the AEMC's National Electricity Amendment (Enhancing operational resilience in relation to indistinct events) Rule 2022.